

## Bearing specification tables

## Contents

### Standard bearings

#### Deep groove ball bearings ..... B 4

Single-row	
Open type.....	B 8
Shielded/sealed type .....	B 20
Snap ring groove/locating snap ring type .....	B 32
Extra-small, miniature ball bearings	
Open/shielded/sealed type.....	B 38
Flanged type (open/shielded type) .....	B 44
Double-row .....	B 50

#### Angular contact ball bearings .... B 52

Single-row .....	B 60
Matched pair .....	B 92
Double-row .....	B 124
Four-point contact ball bearings .....	B 130

#### Self-aligning ball bearings ..... B 134

Open type .....	B 136
Sealed type .....	B 144
Extended inner ring type .....	B 148
Adapter assemblies for self-aligning ball bearings ...	B 150

#### Cylindrical roller bearings ..... B 154

Single-row .....	B 158
Thrust collars .....	B 184
Double-row .....	B 194

#### Tapered roller bearings ..... B 200

Single-row	
Metric series .....	B 204
Inch series .....	B 236
Double-row	
TDO type .....	B 280
TDI type.....	B 296

#### Spherical roller bearings ..... B 302

Spherical roller bearings .....	B 306
Adapter assemblies for spherical roller bearings ....	B 330
Withdrawal sleeves for spherical roller bearings .....	B 338

#### Thrust ball bearings ..... B 348

Single direction .....	B 350
Double direction .....	B 360

#### Spherical thrust roller bearings .... B 366

#### Needle roller bearings ..... B 374

Needle roller and cage assemblies ...	B 388
Drawn cup type .....	B 402
Machined ring type .....	B 424
Thrust .....	B 440
Stud type track rollers (cam followers) .....	B 450
Yoke type track rollers (roller followers) .....	B 454
(Miniature one-way clutches) .....	B 458

#### Ball bearing units ..... B 462

Pillow block type	
With set screws .....	B 470
With adapter .....	B 476
Thick section .....	B 480
Light duty .....	B 482
“Compact” series .....	B 484
Stainless-series .....	B 486
Pressed steel.....	B 488
Square-flanged type .....	B 490
Square-flanged type with spigot joint .....	B 496
Rhombic-flanged type .....	B 500
Light duty .....	B 504
“Compact” series .....	B 506
Stainless-series .....	B 508

#### (Ball bearing units)

Round-flanged type with spigot joint .....	B 510
Pressed steel round-flanged type .....	B 514
Pressed steel rhombic-flanged type .....	B 516
Take-up type .....	B 518
Cartridge type .....	B 524
Ball bearings for units	
Cylindrical bore type (with set screws) ....	B 528
Tapered bore type (with adapter) ...	B 534
Cylindrical bore type (with eccentric locking collar)...	B 538

#### Plummer blocks ..... B 540

Split type	
Standard .....	B 544
Flat bottom .....	B 552
Flat bottom (different/large bore type) .....	B 558
Large size .....	B 564
One-piece type .....	B 570

### Special purpose bearings

#### Ceramic & **EXSEV** bearing series .... C 1

Vacuum environment.....	C 9
Clean environment .....	C 13
Ceramic bearings .....	C 17
Hybrid ceramic bearings.....	C 21
Linear ball bearings for vacuum .....	C 25

#### K-series super thin section

ball bearings .....	C 27
Deep groove type	} .....
Angular contact type	
Four-point contact type	
Sealed type .....	

#### Bearings for machine tool spindles

##### (for support of axial loading) ..... C 47

Double direction	
angular contact thrust ball bearings ....	C 53
Matched pair angular contact ball bearings .....	C 59

#### Precision ball screw support bearings

##### and bearing units .....

Support bearings.....	C 67
Support bearing units.....	C 69

#### Full complement type cylindrical roller

##### bearings for crane sheaves .....

Shielded type .....	C 73
Open type .....	C 77

#### Rolling mill roll neck bearings .... C 81

Four-row cylindrical roller bearings.....	C 85
Four-row tapered roller bearings.....	C 103
Sealed type four-row tapered roller bearings...	C 127

#### Bearings for railway

##### rolling stock axle journals .....

Cylindrical roller bearings .....	C 143
Sealed type cylindrical roller bearings ....	C 145
Sealed type tapered roller bearings	
(ABU bearing) .....	C 147

#### Linear ball bearings .....

Linear ball bearings .....	C 153
Flanged type .....	C 159

#### Accessories .....

Locknuts .....	C 165
Lockwashers .....	C 171
Lock plates .....	C 173

## Deep groove ball bearings

Deep groove ball bearings are available in a variety of sizes, and are the most popular of all rolling bearings. This type of bearing supports radial load and a certain degree of axial load in both directions simultaneously.

- Shielded / sealed type
  - Simplifies sealing structure of applications.
  - Greasing is not necessary because bearings are pre-lubricated.
  - Table 1 on the next page lists major shielded and sealed bearing types and compares their performance.
- With locating snap ring
  - Bearings with a locating snap ring can be fit to the housing easily, as the locating snap ring facilitates axial positioning.
- Extra-small ball bearings and miniature ball bearings
  - The open type is widely used. Also available are the shielded/sealed type and the flanged type; the latter is easily positioned in the axial direction.



### Single-row deep groove ball bearings



Open type

Bore diameter 10 – 500 mm



Shielded/sealed type

Bore diameter 10 – 220 mm



With snap ring groove With locating snap ring

Bore diameter 10 – 130 mm

### Extra-small ball bearings and miniature ball bearings



Bore diameter 1 – 9 mm



Flanged type

Bore diameter 1 – 9 mm

### Double-row deep groove ball bearings



(with filling slot)

Bore diameter 10 – 75 mm

**Table 1 Comparison of shielded and sealed bearing performance**

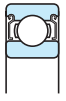
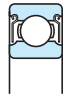
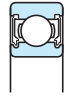
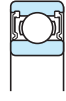
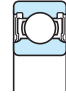
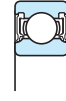
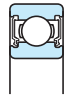
Type	Shielded		Sealed				
	Non-contact type		Non-contact type	Contact type		Extremely light contact type	
	ZZ type	2RU type	2RS type	2RK type	2RD type		
Characteristics	 (a) <sup>1)</sup>	 (b)	 (c)	 (d) <sup>2)</sup>	 (e)	 (f)	 (g)
Friction torque	Small	Small	Large	Large	Small		
High speed performance	Good	Good	Limited because of contact		Good		
Grease sealing property	Good	Better than ZZ type	Better than 2RU type for low-speed applications	Excellent	Excellent		
Dirt resistance	Good	Better than ZZ type	Better than 2RU type	Excellent	Excellent		
Water resistance	Economical	Better than ZZ type but inferior to 2RS, 2RK and 2RD types	Good	Excellent	Better than ZZ and 2RU types		
Operating temperature <sup>3)</sup>	- 30 to +110°C		- 30 to +100°C		- 30 to +110°C		

[Notes] 1) Illustration (a) of the ZZ type shows the relatively small size bearing.  
 2) Illustration (d) of the 2RS type shows the relatively small size bearing.  
 3) The operating temperature range listed is for the standard type. It can be widened by using a different type of grease or sealing material. Consult with JTEKT for details.

■ Handling instructions

- 1) The shielded/sealed type deep groove ball bearing and the deep groove ball bearing with a locating snap ring are designed for use with the inner ring rotating. Consult with JTEKT on use with the outer ring rotating.
- 2) When the axial load is large, make the shaft shoulder and housing shoulder larger than usual. (Referring to the specification table, make the mounting dimension  $d_a$  larger and make  $D_a$  smaller.)

Boundary dimensions	The dimensions of standard series are as specified in JIS B 1512. For extra-small and miniature ball bearings, special series (ML) are specified together with those described above.																																																																			
Tolerances	As specified in JIS B 1514-1. (refer to Table 7-3 on pp. A 54 – A 57.)																																																																			
Radial internal clearance	<ul style="list-style-type: none"> <li>■ Deep groove ball bearings (except extra-small ball bearings and miniature ball bearings) ..... as specified in JIS B 1520 (refer to Table 10-2 on p. A 96.)</li> <li>■ Extra-small ball bearings and miniature ball bearings ..... (refer to Table 10-3 on p. A 96.)</li> <li>■ Deep groove ball bearings for motors ..... (refer to Table 10-7 on p. A 99.)</li> </ul>																																																																			
Recommended fits	<ul style="list-style-type: none"> <li>■ Bearings of classes 0 and 6 ..... (refer to Table 9-4 on pp. A 85, 86.)</li> <li>■ Precision extra-small ball bearings and miniature ball bearings ..... (refer to Table 9-5 on p. A 87.)</li> </ul>																																																																			
Standard cages	<ul style="list-style-type: none"> <li>● Polyamide molded cage (supplementary code : FG, MG )</li> <li>● Pressed steel cage (supplementary code : // )</li> <li>● Copper alloy machined cage (supplementary code : FY )</li> </ul> <p>[Remark] For certain applications, stainless steel sheet pressed cages (YS) may also be used.</p>	<table border="1"> <thead> <tr> <th colspan="4">Application of standard cages</th> </tr> <tr> <th>Bearing series</th> <th>Molded cage</th> <th>Pressed cage</th> <th>Machined cage</th> </tr> </thead> <tbody> <tr> <td>68</td> <td>683 – 689</td> <td>-</td> <td>-</td> </tr> <tr> <td>69</td> <td>693 – 699</td> <td>-</td> <td>-</td> </tr> <tr> <td>60</td> <td>603 – 609</td> <td>-</td> <td>-</td> </tr> <tr> <td>62</td> <td>623 – 629</td> <td>-</td> <td>-</td> </tr> <tr> <td>63</td> <td>633 – 639</td> <td>-</td> <td>-</td> </tr> <tr> <td>68</td> <td>-</td> <td>6800 – 6838</td> <td>6840 – 68/600</td> </tr> <tr> <td>69</td> <td>-</td> <td>6900 – 6918</td> <td>6920 – 6980</td> </tr> <tr> <td>160</td> <td>-</td> <td>16001 – 16028</td> <td>16030 – 16072</td> </tr> <tr> <td>60</td> <td>6000 – 6009</td> <td>6010 – 6034</td> <td>6036 – 6084</td> </tr> <tr> <td>62</td> <td>6200 – 6208</td> <td>6209 – 6230</td> <td>6232 – 6248</td> </tr> <tr> <td>63</td> <td>6300 – 6306</td> <td>6307 – 6328</td> <td>6330 – 6340</td> </tr> <tr> <td>64</td> <td>-</td> <td>6403 – 6418</td> <td>-</td> </tr> <tr> <td>42</td> <td>-</td> <td>4200 – 4215</td> <td>-</td> </tr> <tr> <td>43</td> <td>-</td> <td>4302 – 4315</td> <td>-</td> </tr> </tbody> </table>			Application of standard cages				Bearing series	Molded cage	Pressed cage	Machined cage	68	683 – 689	-	-	69	693 – 699	-	-	60	603 – 609	-	-	62	623 – 629	-	-	63	633 – 639	-	-	68	-	6800 – 6838	6840 – 68/600	69	-	6900 – 6918	6920 – 6980	160	-	16001 – 16028	16030 – 16072	60	6000 – 6009	6010 – 6034	6036 – 6084	62	6200 – 6208	6209 – 6230	6232 – 6248	63	6300 – 6306	6307 – 6328	6330 – 6340	64	-	6403 – 6418	-	42	-	4200 – 4215	-	43	-	4302 – 4315	-
Application of standard cages																																																																				
Bearing series	Molded cage	Pressed cage	Machined cage																																																																	
68	683 – 689	-	-																																																																	
69	693 – 699	-	-																																																																	
60	603 – 609	-	-																																																																	
62	623 – 629	-	-																																																																	
63	633 – 639	-	-																																																																	
68	-	6800 – 6838	6840 – 68/600																																																																	
69	-	6900 – 6918	6920 – 6980																																																																	
160	-	16001 – 16028	16030 – 16072																																																																	
60	6000 – 6009	6010 – 6034	6036 – 6084																																																																	
62	6200 – 6208	6209 – 6230	6232 – 6248																																																																	
63	6300 – 6306	6307 – 6328	6330 – 6340																																																																	
64	-	6403 – 6418	-																																																																	
42	-	4200 – 4215	-																																																																	
43	-	4302 – 4315	-																																																																	
Allowable misalignment	0.002 3 – 0.003 4 rad ( 8' – 12' )																																																																			
Equivalent radial load (Single/double-row)	Dynamic equivalent radial load $P_r = XF_r + YF_a$ (refer to the table on the right for values X and Y.)  Static equivalent radial load $P_{0r} = 0.6F_r + 0.5F_a$ (when the value of $P_{0r} < F_r$ , $P_{0r} = F_r$ )	<table border="1"> <thead> <tr> <th rowspan="2"><math>\frac{if_0F_a}{C_{0r}}</math></th> <th rowspan="2">e</th> <th colspan="2"><math>\frac{F_a}{F_r} \leq e</math></th> <th colspan="2"><math>\frac{F_a}{F_r} &gt; e</math></th> </tr> <tr> <th>X</th> <th>Y</th> <th>X</th> <th>Y</th> </tr> </thead> <tbody> <tr> <td>0.172</td> <td>0.19</td> <td rowspan="3">1</td> <td rowspan="3">0</td> <td rowspan="3">0.56</td> <td>2.30</td> </tr> <tr> <td>0.345</td> <td>0.22</td> <td>1.99</td> </tr> <tr> <td>0.689</td> <td>0.26</td> <td>1.71</td> </tr> <tr> <td>1.03</td> <td>0.28</td> <td rowspan="4">0.56</td> <td rowspan="4">0</td> <td rowspan="4">0.56</td> <td>1.55</td> </tr> <tr> <td>1.38</td> <td>0.30</td> <td>1.45</td> </tr> <tr> <td>2.07</td> <td>0.34</td> <td>1.31</td> </tr> <tr> <td>3.45</td> <td>0.38</td> <td>1.15</td> </tr> <tr> <td>5.17</td> <td>0.42</td> <td rowspan="2">0.44</td> <td rowspan="2">0</td> <td rowspan="2">0.44</td> <td>1.04</td> </tr> <tr> <td>6.89</td> <td>0.44</td> <td>1.00</td> </tr> </tbody> </table>	$\frac{if_0F_a}{C_{0r}}$	e	$\frac{F_a}{F_r} \leq e$		$\frac{F_a}{F_r} > e$		X	Y	X	Y	0.172	0.19	1	0	0.56	2.30	0.345	0.22	1.99	0.689	0.26	1.71	1.03	0.28	0.56	0	0.56	1.55	1.38	0.30	1.45	2.07	0.34	1.31	3.45	0.38	1.15	5.17	0.42	0.44	0	0.44	1.04	6.89	0.44	1.00																				
$\frac{if_0F_a}{C_{0r}}$	e	$\frac{F_a}{F_r} \leq e$			$\frac{F_a}{F_r} > e$																																																															
		X	Y	X	Y																																																															
0.172	0.19	1	0	0.56	2.30																																																															
0.345	0.22				1.99																																																															
0.689	0.26				1.71																																																															
1.03	0.28	0.56	0	0.56	1.55																																																															
1.38	0.30				1.45																																																															
2.07	0.34				1.31																																																															
3.45	0.38				1.15																																																															
5.17	0.42	0.44	0	0.44	1.04																																																															
6.89	0.44				1.00																																																															

Factor  $f_0$  is shown in the bearing dimension table.

Single-row deep groove ball bearings  
open type

*d* 10 ~ (20) mm

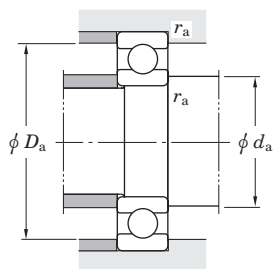
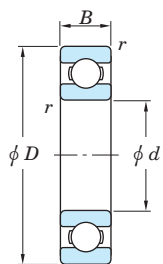

*d* (20) ~ (30) mm

Boundary dimensions (mm)				Basic load ratings (kN)		Factor $f_0$	Limiting speeds ( $\text{min}^{-1}$ )		Bearing No.	Mounting dimensions (mm)			(Refer.) Mass (kg)
<i>d</i>	<i>D</i>	<i>B</i>	$r_{\text{min}}$	$C_r$	$C_{0r}$		Grease lub.	Oil lub.		$d_a$ min.	$D_a$ max.	$r_a$ max.	
<b>10</b>	19	5	0.3	1.70	0.84	14.8	37 000	43 000	<b>6800</b>	12	17	0.3	0.005
	22	6	0.3	2.70	1.25	14.0	34 000	41 000	<b>6900</b>	12	20	0.3	0.010
	26	8	0.3	4.55	1.95	12.3	31 000	36 000	<b>6000</b>	12	24	0.3	0.019
	30	9	0.6	5.10	2.40	13.2	24 000	29 000	<b>6200</b>	14	26	0.6	0.032
	35	11	0.6	8.10	3.45	11.2	22 000	27 000	<b>6300</b>	14	31	0.6	0.053
<b>12</b>	21	5	0.3	1.90	1.05	15.3	33 000	39 000	<b>6801</b>	14	19	0.3	0.006
	24	6	0.3	2.90	1.45	14.5	31 000	36 000	<b>6901</b>	14	22	0.3	0.011
	28	7	0.3	5.10	2.40	13.2	27 000	32 000	<b>16001</b>	14	26	0.3	0.024
	28	8	0.3	5.10	2.40	13.2	27 000	32 000	<b>6001</b>	14	26	0.3	0.022
	32	10	0.6	6.80	3.05	12.3	22 000	27 000	<b>6201</b>	16	28	0.6	0.037
	37	12	1	9.70	4.20	11.1	20 000	25 000	<b>6301</b>	17	32	1	0.060
<b>15</b>	24	5	0.3	2.10	1.25	15.8	28 000	33 000	<b>6802</b>	17	22	0.3	0.007
	28	7	0.3	4.30	2.25	14.3	26 000	30 000	<b>6902</b>	17	26	0.3	0.017
	32	8	0.3	5.60	2.85	13.9	23 000	28 000	<b>16002</b>	17	30	0.3	0.025
	32	9	0.3	5.60	2.85	13.9	23 000	27 000	<b>6002</b>	17	30	0.3	0.030
	35	11	0.6	7.65	3.75	13.2	20 000	24 000	<b>6202</b>	19	31	0.6	0.045
	42	13	1	11.4	5.45	12.3	17 000	20 000	<b>6302</b>	20	37	1	0.082
<b>17</b>	26	5	0.3	2.60	1.55	15.7	26 000	30 000	<b>6803</b>	19	24	0.3	0.008
	30	7	0.3	4.60	2.55	14.7	23 000	28 000	<b>6903</b>	19	28	0.3	0.018
	35	8	0.3	6.00	3.25	14.4	21 000	25 000	<b>16003</b>	19	33	0.3	0.032
	35	10	0.3	6.00	3.25	14.4	21 000	25 000	<b>6003</b>	19	33	0.3	0.039
	40	12	0.6	9.55	4.80	13.2	17 000	21 000	<b>6203</b>	21	36	0.6	0.065
	47	14	1	13.6	6.65	12.4	15 000	18 000	<b>6303</b>	22	42	1	0.115
	47	14	1	15.6	7.60	12.0	15 000	18 000	<b>6303R</b>	22	42	1	0.121
	62	17	1.1	20.7	9.85	11.6	13 000	15 000	<b>6403</b>	23.5	55.5	1	0.270
<b>20</b>	32	7	0.3	4.00	2.45	15.5	21 000	25 000	<b>6804</b>	22	30	0.3	0.018
	37	9	0.3	6.35	3.70	14.7	19 000	23 000	<b>6904</b>	22	35	0.3	0.036
	42	8	0.3	7.95	4.50	14.4	17 000	21 000	<b>16004</b>	22	40	0.3	0.050

[Remark] Standard cage types used for the above bearings are described earlier in this section.

Boundary dimensions (mm)				Basic load ratings (kN)		Factor $f_0$	Limiting speeds ( $\text{min}^{-1}$ )		Bearing No.	Mounting dimensions (mm)			(Refer.) Mass (kg)
<i>d</i>	<i>D</i>	<i>B</i>	$r_{\text{min}}$	$C_r$	$C_{0r}$		Grease lub.	Oil lub.		$d_a$ min.	$D_a$ max.	$r_a$ max.	
<b>20</b>	42	12	0.6	9.40	5.05	13.9	17 000	21 000	<b>6004</b>	24	38	0.6	0.069
	42	12	0.6	11.5	5.85	13.0	18 000	21 000	<b>6004R</b>	24	38	0.6	0.073
	47	14	1	12.8	6.65	13.2	15 000	17 000	<b>6204</b>	25	42	1	0.106
	47	14	1	15.6	7.60	12.0	15 000	18 000	<b>6204R</b>	25	42	1	0.114
	52	15	1.1	15.9	7.85	12.3	14 000	17 000	<b>6304</b>	26.5	45.5	1	0.144
	52	15	1.1	18.1	8.95	12.0	14 000	16 000	<b>6304R</b>	26.5	45.5	1	0.151
	72	19	1.1	31.0	15.2	11.1	11 000	13 000	<b>6404</b>	26.5	65.5	1	0.400
	<b>22</b>	44	12	0.6	9.40	5.15	14.1	17 000	20 000	<b>60/22</b>	26	40	0.6
50		14	1	12.8	6.65	13.2	15 000	17 000	<b>62/22</b>	27	45	1	0.118
56		16	1.1	18.5	9.40	12.6	13 000	15 000	<b>63/22</b>	28.5	49.5	1	0.201
<b>25</b>	37	7	0.3	4.30	2.95	16.0	18 000	21 000	<b>6805</b>	27	35	0.3	0.022
	42	9	0.3	7.00	4.55	15.4	16 000	19 000	<b>6905</b>	27	40	0.3	0.041
	47	8	0.3	8.85	5.60	15.1	15 000	18 000	<b>16005</b>	27	45	0.3	0.060
	47	12	0.6	10.1	5.85	14.5	15 000	18 000	<b>6005</b>	29	43	0.6	0.080
	52	15	1	14.0	7.85	13.9	13 000	15 000	<b>6205</b>	30	47	1	0.128
	52	15	1	17.6	9.30	12.8	13 000	16 000	<b>6205R</b>	30	47	1	0.138
	62	17	1.1	20.6	11.3	13.2	11 000	13 000	<b>6305</b>	31.5	55.5	1	0.232
	62	17	1.1	26.2	13.4	11.9	11 000	14 000	<b>6305R</b>	31.5	55.5	1	0.255
80	21	1.5	36.1	19.4	12.2	9 100	11 000	<b>6405</b>	33	72	1.5	0.530	
<b>28</b>	52	12	0.6	12.4	7.40	14.5	14 000	16 000	<b>60/28</b>	32	48	0.6	0.097
	58	16	1	17.9	9.75	13.4	12 000	14 000	<b>62/28</b>	33	53	1	0.173
	68	18	1.1	23.5	13.1	13.3	10 000	12 000	<b>63/28</b>	34.5	61.5	1	0.328
<b>30</b>	42	7	0.3	4.55	3.40	16.4	15 000	18 000	<b>6806</b>	32	40	0.3	0.026
	47	9	0.3	7.25	5.00	15.8	14 000	17 000	<b>6906</b>	32	45	0.3	0.045
	55	9	0.3	11.2	7.35	15.2	13 000	15 000	<b>16006</b>	32	53	0.3	0.085
	55	13	1	13.2	8.25	14.7	13 000	15 000	<b>6006</b>	35	50	1	0.116
	62	16	1	19.5	11.3	13.9	11 000	13 000	<b>6206</b>	35	57	1	0.199
	62	16	1	23.4	12.8	13.0	11 000	13 000	<b>6206R</b>	35	57	1	0.212

Single-row deep groove ball bearings  
open type

$d$  (30) ~ (45) mm

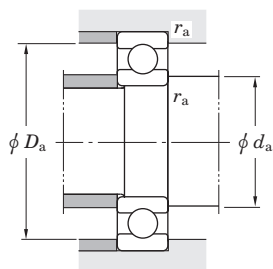
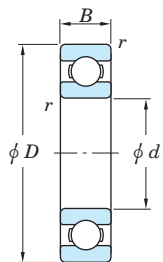

$d$  (45) ~ (65) mm

Boundary dimensions (mm)				Basic load ratings (kN)		Factor $f_0$	Limiting speeds ( $\text{min}^{-1}$ )		Bearing No.	Mounting dimensions (mm)			(Refer.) Mass (kg)
$d$	$D$	$B$	$r_{\text{min}}$	$C_r$	$C_{0r}$		Grease lub.	Oil lub.		$d_a$ min.	$D_a$ max.	$r_a$ max.	
<b>30</b>	72	19	1.1	26.7	15.0	13.3	9 600	12 000	<b>6306</b>	36.5	65.5	1	0.346
	72	19	1.1	33.4	17.7	12.0	9 800	12 000	<b>6306R</b>	36.5	65.5	1	0.379
	90	23	1.5	43.4	23.9	12.3	8 100	9 700	<b>6406</b>	38	82	1.5	0.735
<b>32</b>	58	13	1	15.0	9.15	14.5	12 000	14 000	<b>60/32</b>	37	53	1	0.127
	65	17	1	23.5	13.1	13.3	10 000	12 000	<b>62/32</b>	37	60	1	0.228
	75	20	1.1	30.1	16.2	12.7	9 300	11 000	<b>63/32</b>	38.5	68.5	1	0.437
<b>35</b>	47	7	0.3	4.75	3.85	16.5	13 000	16 000	<b>6807</b>	37	45	0.3	0.030
	55	10	0.6	10.9	7.75	15.7	12 000	14 000	<b>6907</b>	39	51	0.6	0.073
	62	9	0.3	12.2	8.85	15.7	11 000	13 000	<b>16007</b>	37	60	0.3	0.110
	62	14	1	15.9	10.3	14.9	11 000	13 000	<b>6007</b>	40	58	1	0.155
	72	17	1.1	25.7	15.4	13.9	9 200	11 000	<b>6207</b>	41.5	65.5	1	0.288
	72	17	1.1	31.0	17.5	12.9	9 300	11 000	<b>6207R</b>	41.5	65.5	1	0.309
	80	21	1.5	33.4	19.3	13.2	8 500	10 000	<b>6307</b>	43	72	1.5	0.457
	80	21	1.5	40.0	21.7	12.1	8 700	10 000	<b>6307R</b>	43	72	1.5	0.494
	100	25	1.5	55.0	31.0	12.2	7 200	8 600	<b>6407</b>	43	92	1.5	0.952
	<b>40</b>	52	7	0.3	4.95	4.20	16.3	12 000	14 000	<b>6808</b>	42	50	0.3
62		12	0.6	13.7	9.95	15.6	11 000	13 000	<b>6908</b>	44	58	0.6	0.112
68		9	0.3	12.6	9.65	16.0	9 800	12 000	<b>16008</b>	42	66	0.3	0.125
68		15	1	16.7	11.5	15.2	10 000	12 000	<b>6008</b>	45	63	1	0.192
80		18	1.1	29.1	17.8	14.0	8 300	10 000	<b>6208</b>	46.5	73.5	1	0.366
90		23	1.5	40.7	24.0	13.2	7 700	9 200	<b>6308</b>	48	82	1.5	0.633
110		27	2	63.7	36.6	12.3	6 600	7 900	<b>6408</b>	49	101	2	1.23
<b>45</b>		58	7	0.3	6.20	5.40	16.3	11 000	13 000	<b>6809</b>	47	56	0.3
	68	12	0.6	14.1	10.9	15.9	9 700	11 000	<b>6909</b>	49	64	0.6	0.132
	75	10	0.6	15.5	12.3	16.0	8 900	10 000	<b>16009</b>	49	71	0.6	0.170
	75	16	1	21.0	15.1	15.3	9 200	11 000	<b>6009</b>	50	70	1	0.245
	85	19	1.1	32.7	20.3	14.0	7 700	9 200	<b>6209</b>	51.5	78.5	1	0.407
	100	25	1.5	48.9	29.5	13.3	6 800	8 100	<b>6309</b>	53	92	1.5	0.833

[Remark] Standard cage types used for the above bearings are described earlier in this section.

Boundary dimensions (mm)				Basic load ratings (kN)		Factor $f_0$	Limiting speeds ( $\text{min}^{-1}$ )		Bearing No.	Mounting dimensions (mm)			(Refer.) Mass (kg)
$d$	$D$	$B$	$r_{\text{min}}$	$C_r$	$C_{0r}$		Grease lub.	Oil lub.		$d_a$ min.	$D_a$ max.	$r_a$ max.	
<b>45</b>	120	29	2	77.2	45.1	12.2	6 000	7 200	<b>6409</b>	54	111	2	1.53
<b>50</b>	65	7	0.3	6.60	6.10	16.1	9 600	11 000	<b>6810</b>	52	63	0.3	0.052
	72	12	0.6	14.5	11.7	16.1	9 000	11 000	<b>6910</b>	54	68	0.6	0.133
	80	10	0.6	16.0	13.3	16.2	8 200	9 700	<b>16010</b>	54	76	0.6	0.180
	80	16	1	21.8	16.6	15.6	8 400	9 900	<b>6010</b>	55	75	1	0.261
	90	20	1.1	35.1	23.3	14.4	7 100	8 500	<b>6210</b>	56.5	83.5	1	0.463
	90	20	1.1	40.4	25.5	13.9	7 100	8 600	<b>6210R</b>	56.5	83.5	1	0.487
	110	27	2	62.0	38.3	13.2	6 100	7 300	<b>6310</b>	59	101	2	1.07
130	31	2.1	83.0	49.5	12.5	5 500	6 600	<b>6410</b>	61	119	2	1.88	
<b>55</b>	72	9	0.3	8.80	8.10	16.2	8 700	10 000	<b>6811</b>	57	70	0.3	0.083
	80	13	1	16.6	14.1	16.2	8 100	9 600	<b>6911</b>	60	75	1	0.185
	90	11	0.6	19.3	16.3	16.2	7 400	8 800	<b>16011</b>	59	86	0.6	0.260
	90	18	1.1	28.3	21.2	15.3	7 600	8 900	<b>6011</b>	61.5	83.5	1	0.385
	100	21	1.5	43.4	29.4	14.4	6 300	7 600	<b>6211</b>	63	92	1.5	0.607
	120	29	2	71.6	45.0	13.2	5 600	6 700	<b>6311</b>	64	111	2	1.37
140	33	2.1	100	62.3	12.2	5 000	6 000	<b>6411</b>	66	129	2	2.29	
<b>60</b>	78	10	0.3	11.5	10.6	16.3	8 000	9 400	<b>6812</b>	62	76	0.3	0.104
	85	13	1	20.2	17.3	16.2	7 500	8 900	<b>6912</b>	65	80	1	0.192
	95	11	0.6	19.8	17.6	16.4	6 900	8 100	<b>16012</b>	64	91	0.6	0.280
	95	18	1.1	29.4	23.2	15.6	7 100	8 400	<b>6012</b>	66.5	88.5	1	0.415
	110	22	1.5	52.4	36.2	14.4	5 700	6 900	<b>6212</b>	68	102	1.5	0.783
	130	31	2.1	81.9	52.2	13.2	5 200	6 200	<b>6312</b>	71	119	2	1.70
150	35	2.1	110	70.8	12.4	4 600	5 500	<b>6412</b>	71	139	2	2.77	
<b>65</b>	85	10	0.6	11.9	11.5	16.2	7 300	8 600	<b>6813</b>	69	81	0.6	0.126
	90	13	1	17.4	16.1	16.6	7 100	8 400	<b>6913</b>	70	85	1	0.211
	100	11	0.6	17.1	16.0	16.5	6 600	7 800	<b>16013</b>	69	96	0.6	0.300
	100	18	1.1	30.5	25.2	15.8	6 600	7 800	<b>6013</b>	71.5	93.5	1	0.435

Single-row deep groove ball bearings  
open type

$d$  (65) ~ (85) mm

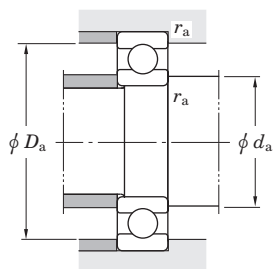
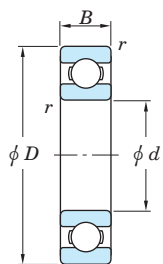

$d$  (85) ~ 105 mm

Boundary dimensions (mm)				Basic load ratings (kN)		Factor $f_0$	Limiting speeds ( $\text{min}^{-1}$ )		Bearing No.	Mounting dimensions (mm)			(Refer.) Mass (kg)
$d$	$D$	$B$	$r_{\text{min}}$	$C_r$	$C_{0r}$		Grease lub.	Oil lub.		$d_a$ min.	$D_a$ max.	$r_a$ max.	
<b>65</b>	120	23	1.5	57.2	40.1	14.4	5 400	6 400	<b>6213</b>	73	112	1.5	0.990
	140	33	2.1	92.7	59.9	13.2	4 800	5 800	<b>6313</b>	76	129	2	2.08
	160	37	2.1	118	79.2	12.4	4 300	5 200	<b>6413</b>	76	149	2	3.30
<b>70</b>	90	10	0.6	12.1	11.9	16.1	6 800	8 100	<b>6814</b>	74	86	0.6	0.134
	100	16	1	23.7	21.2	16.3	6 400	7 600	<b>6914</b>	75	95	1	0.342
	110	13	0.6	30.1	25.6	16.0	6 100	7 200	<b>16014</b>	74	106	0.6	0.433
	110	20	1.1	38.1	30.9	15.6	6 100	7 200	<b>6014</b>	76.5	103.5	1	0.602
	125	24	1.5	62.2	44.1	14.5	5 100	6 100	<b>6214</b>	78	117	1.5	1.07
	150	35	2.1	104	68.2	13.2	4 500	5 400	<b>6314</b>	81	139	2	2.52
	180	42	3	144	104	12.2	3 900	4 600	<b>6414</b>	83	167	2.5	4.83
<b>75</b>	95	10	0.6	12.5	12.9	16.0	6 400	7 600	<b>6815</b>	79	91	0.6	0.142
	105	16	1	24.4	22.6	16.5	6 100	7 200	<b>6915</b>	80	100	1	0.363
	115	13	0.6	27.5	25.3	16.4	5 700	6 700	<b>16015</b>	79	111	0.6	0.457
	115	20	1.1	39.6	33.5	15.8	5 700	6 800	<b>6015</b>	81.5	108.5	1	0.638
	130	25	1.5	67.4	48.3	14.5	4 800	5 800	<b>6215</b>	83	122	1.5	1.18
	160	37	2.1	113	77.2	13.2	4 200	5 000	<b>6315</b>	86	149	2	3.02
	190	45	3	154	115	12.3	3 600	4 400	<b>6415</b>	88	177	2.5	5.87
	<b>80</b>	100	10	0.6	12.7	13.3	16.0	6 100	7 200	<b>6816</b>	84	96	0.6
110		16	1	25.0	24.0	16.6	5 700	6 800	<b>6916</b>	85	105	1	0.382
125		14	0.6	31.7	29.7	16.4	5 200	6 100	<b>16016</b>	84	121	0.6	0.597
125		22	1.1	47.6	39.8	15.6	5 300	6 300	<b>6016</b>	86.5	118.5	1	0.850
140		26	2	72.7	53.0	14.6	4 500	5 400	<b>6216</b>	89	131	2	1.40
170		39	2.1	123	86.7	13.3	3 900	4 700	<b>6316</b>	91	159	2	3.59
200		48	3	164	125	12.3	3 400	4 100	<b>6416</b>	93	187	2.5	6.84
<b>85</b>	110	13	1	18.7	19.0	16.2	5 600	6 600	<b>6817</b>	90	105	1	0.266
	120	18	1.1	31.9	29.6	16.4	5 300	6 300	<b>6917</b>	91.5	113.5	1	0.535
	130	14	0.6	32.6	31.7	16.5	4 900	5 800	<b>16017</b>	89	126	0.6	0.626

[Remark] Standard cage types used for the above bearings are described earlier in this section.

Boundary dimensions (mm)				Basic load ratings (kN)		Factor $f_0$	Limiting speeds ( $\text{min}^{-1}$ )		Bearing No.	Mounting dimensions (mm)			(Refer.) Mass (kg)
$d$	$D$	$B$	$r_{\text{min}}$	$C_r$	$C_{0r}$		Grease lub.	Oil lub.		$d_a$ min.	$D_a$ max.	$r_a$ max.	
<b>85</b>	130	22	1.1	49.5	43.1	15.8	5 000	5 900	<b>6017</b>	91.5	123.5	1	0.890
	150	28	2	84.0	61.9	14.5	4 200	5 000	<b>6217</b>	94	141	2	1.79
	180	41	3	133	96.8	13.3	3 700	4 400	<b>6317</b>	98	167	2.5	4.23
	210	52	4	173	136	12.3	3 300	3 900	<b>6417</b>	101	194	3	8.07
<b>90</b>	115	13	1	19.0	19.7	16.1	5 300	6 300	<b>6818</b>	95	110	1	0.279
	125	18	1.1	32.8	31.6	16.5	5 100	6 000	<b>6918</b>	96.5	118.5	1	0.565
	140	16	1	39.9	37.0	16.3	4 700	5 600	<b>16018</b>	95	135	1	0.848
	140	24	1.5	58.2	49.7	15.6	4 700	5 600	<b>6018</b>	98	132	1.5	1.16
	160	30	2	96.1	71.5	14.5	3 900	4 700	<b>6218</b>	99	151	2	2.15
	190	43	3	143	107	13.3	3 500	4 200	<b>6318</b>	103	177	2.5	4.91
<b>95</b>	225	54	4	184	149	12.5	3 100	3 700	<b>6418</b>	106	209	3	9.78
	130	18	1.1	33.7	33.5	16.6	4 800	5 700	<b>6919</b>	101.5	123.5	1	0.705
	145	16	1	41.2	39.6	16.4	4 500	5 300	<b>16019</b>	100	140	1	0.885
	145	24	1.5	60.4	53.9	15.8	4 400	5 200	<b>6019</b>	103	137	1.5	1.21
<b>100</b>	170	32	2.1	109	81.9	14.4	3 700	4 400	<b>6219</b>	106	159	2	2.62
	200	45	3	153	119	13.3	3 300	4 000	<b>6319</b>	108	187	2.5	5.67
	125	13	1	19.6	21.2	16.0	4 800	5 700	<b>6820</b>	105	120	1	0.309
	140	20	1.1	45.0	41.9	16.2	4 500	5 300	<b>6920</b>	106.5	133.5	1	0.960
<b>105</b>	150	16	1	42.4	42.1	16.5	4 300	5 100	<b>16020</b>	105	145	1	0.910
	150	24	1.5	60.2	54.2	15.9	4 300	5 100	<b>6020</b>	108	142	1.5	1.25
	180	34	2.1	122	93.1	14.4	3 500	4 200	<b>6220</b>	111	169	2	3.14
	215	47	3	173	141	13.2	3 000	3 600	<b>6320</b>	113	202	2.5	7.00
	145	20	1.1	46.5	44.8	16.4	4 300	5 100	<b>6921</b>	111.5	138.5	1	1.00
	160	18	1	41.9	42.2	16.5	4 100	4 800	<b>16021</b>	110	155	1	1.20
	160	26	2	72.3	65.8	15.8	4 000	4 700	<b>6021</b>	114	151	2	1.59
<b>105</b>	190	36	2.1	133	105	14.4	3 300	3 900	<b>6221</b>	116	179	2	3.70
	225	49	3	184	153	13.2	2 900	3 500	<b>6321</b>	118	212	2.5	8.05



Single-row deep groove ball bearings  
open type

$d$  110 ~ (150) mm

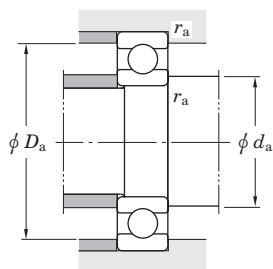
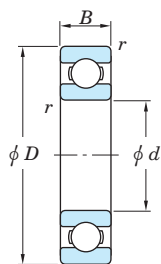

$d$  (150) ~ (200) mm

Boundary dimensions (mm)				Basic load ratings (kN)		Factor $f_0$	Limiting speeds ( $\text{min}^{-1}$ )		Bearing No.	Mounting dimensions (mm)			(Refer.) Mass (kg)
$d$	$D$	$B$	$r_{\text{min}}$	$C_r$	$C_{0r}$		Grease lub.	Oil lub.		$d_a$ min.	$D_a$ max.	$r_a$ max.	
<b>110</b>	140	16	1	28.1	30.7	16.1	4 300	5 100	<b>6822</b>	115	135	1	0.606
	150	20	1.1	47.9	47.8	16.4	4 100	4 900	<b>6922</b>	116.5	143.5	1	1.04
	170	19	1	57.5	56.7	16.3	3 800	4 500	<b>16022</b>	115	165	1	1.46
	170	28	2	82.0	73.0	15.6	3 800	4 500	<b>6022</b>	119	161	2	1.96
	200	38	2.1	144	117	14.4	3 100	3 700	<b>6222</b>	121	189	2	4.36
	240	50	3	205	180	13.2	2 700	3 200	<b>6322</b>	123	227	2.5	9.54
<b>120</b>	150	16	1	29.0	33.0	16.0	4 000	4 700	<b>6824</b>	125	145	1	0.655
	165	22	1.1	57.2	56.9	16.4	3 800	4 400	<b>6924</b>	126.5	158.5	1	1.41
	180	19	1	63.2	63.3	16.4	3 600	4 200	<b>16024</b>	125	175	1	1.80
	180	28	2	85.0	79.3	15.9	3 600	4 200	<b>6024</b>	129	171	2	2.07
	215	40	2.1	155	131	14.4	2 900	3 400	<b>6224</b>	131	204	2	5.15
	260	55	3	207	185	13.5	2 500	3 000	<b>6324</b>	133	247	2.5	12.5
<b>130</b>	165	18	1.1	36.9	41.2	16.1	3 600	4 300	<b>6826</b>	136.5	158.5	1	0.939
	180	24	1.5	65.2	67.4	16.3	3 400	4 100	<b>6926</b>	138	172	1.5	1.86
	200	22	1.1	71.3	74.8	11.2	3 000	3 600	<b>16026</b>	136.5	193.5	1	2.69
	200	33	2	106	101	15.8	3 200	3 800	<b>6026</b>	139	191	2	3.16
	230	40	3	167	146	14.5	2 700	3 200	<b>6226</b>	143	217	2.5	5.82
	280	58	4	229	214	13.6	2 300	2 700	<b>6326</b>	146	264	3	15.1
<b>140</b>	175	18	1.1	38.2	44.4	16.0	3 400	4 000	<b>6828</b>	146.5	168.5	1	1.00
	190	24	1.5	71.3	74.8	16.5	3 200	3 800	<b>6928</b>	148	182	1.5	1.98
	210	22	1.1	65.8	71.1	16.5	2 900	3 400	<b>16028</b>	146.5	203.5	1	2.86
	210	33	2	110	109	15.9	3 000	3 600	<b>6028</b>	149	201	2	3.55
	250	42	3	166	150	14.8	2 400	2 900	<b>6228</b>	153	237	2.5	7.45
	300	62	4	253	246	13.6	2 100	2 500	<b>6328</b>	156	284	3	19.4
<b>150</b>	190	20	1.1	47.8	54.9	16.1	3 100	3 700	<b>6830</b>	156.5	183.5	1	1.40
	210	28	2	93.4	94.3	16.2	2 900	3 400	<b>6930</b>	159	201	2	3.05
	225	24	1.1	91.2	99.3	16.6	2 700	3 100	<b>16030</b>	156.5	218.5	1	3.58
	225	35	2.1	125	126	16.0	2 800	3 300	<b>6030</b>	161	214	2	4.22

[Remark] Standard cage types used for the above bearings are described earlier in this section.

Boundary dimensions (mm)				Basic load ratings (kN)		Factor $f_0$	Limiting speeds ( $\text{min}^{-1}$ )		Bearing No.	Mounting dimensions (mm)			(Refer.) Mass (kg)
$d$	$D$	$B$	$r_{\text{min}}$	$C_r$	$C_{0r}$		Grease lub.	Oil lub.		$d_a$ min.	$D_a$ max.	$r_a$ max.	
<b>150</b>	270	45	3	176	168	15.1	2 200	2 700	<b>6230</b>	163	257	2.5	9.41
	320	65	4	275	284	13.9	1 900	2 300	<b>6330</b>	166	304	3	26.2
<b>160</b>	200	20	1.1	48.4	56.9	16.1	2 900	3 400	<b>6832</b>	166.5	193.5	1	1.45
	220	28	2	96.1	101	16.4	2 700	3 200	<b>6932</b>	169	211	2	3.20
	240	25	1.5	98.8	108	16.5	2 600	3 100	<b>16032</b>	168	232	1.5	4.25
	240	38	2.1	136	135	15.9	2 600	3 000	<b>6032</b>	171	229	2	5.22
	290	48	3	185	186	15.4	2 100	2 500	<b>6232</b>	173	277	2.5	14.3
	340	68	4	278	286	13.9	1 800	2 200	<b>6332</b>	176	324	3	29.0
<b>170</b>	215	22	1.1	59.8	70.5	16.1	2 700	3 200	<b>6834</b>	176.5	208.5	1	1.90
	230	28	2	98.8	108	16.5	2 600	3 100	<b>6934</b>	179	221	2	3.35
	260	28	1.5	114	127	16.5	2 300	2 700	<b>16034</b>	178	252	1.5	5.75
	260	42	2.1	161	161	15.8	2 400	2 800	<b>6034</b>	181	249	2	6.80
	310	52	4	212	223	15.3	1 900	2 300	<b>6234</b>	186	294	3	17.5
	360	72	4	326	355	13.6	1 700	2 000	<b>6334</b>	186	344	3	38.6
<b>180</b>	225	22	1.1	60.7	73.1	16.1	2 600	3 000	<b>6836</b>	186.5	218.5	1	2.00
	250	33	2	123	129	16.3	2 400	2 800	<b>6936</b>	189	241	2	4.90
	280	31	2	135	148	16.4	2 100	2 500	<b>16036</b>	189	271	2	7.55
	280	46	2.1	182	194	15.8	2 200	2 600	<b>6036</b>	191	269	2	10.3
	320	52	4	227	241	15.1	1 800	2 200	<b>6236</b>	196	304	3	18.3
	380	75	4	354	407	13.9	1 600	1 900	<b>6336</b>	196	364	3	44.7
<b>190</b>	240	24	1.5	73.1	88.1	16.1	2 400	2 800	<b>6838</b>	198	232	1.5	2.60
	260	33	2	126	138	16.4	2 300	2 700	<b>6938</b>	199	251	2	5.20
	290	31	2	139	158	16.6	2 000	2 400	<b>16038</b>	199	281	2	7.85
	290	46	2.1	188	201	15.8	2 100	2 500	<b>6038</b>	201	279	2	10.8
	340	55	4	255	281	15.0	1 700	2 000	<b>6238</b>	206	324	3	23.0
	400	78	5	355	415	14.1	1 500	1 800	<b>6338</b>	210	380	4	51.5
<b>200</b>	250	24	1.5	78.0	93.6	16.1	2 300	2 700	<b>6840</b>	208	242	1.5	2.70



Single-row deep groove ball bearings  
open type

$d$  (200) ~ (280) mm

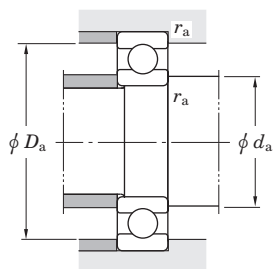
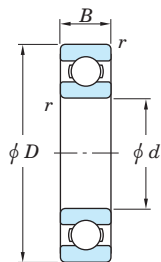

Boundary dimensions (mm)				Basic load ratings (kN)		Factor $f_0$	Limiting speeds ( $\text{min}^{-1}$ )		Bearing No.	Mounting dimensions (mm)			(Refer.) Mass (kg)
$d$	$D$	$B$	$r_{\text{min}}$	$C_r$	$C_{0r}$		Grease lub.	Oil lub.		$d_a$ min.	$D_a$ max.	$r_a$ max.	
<b>200</b>	280	38	2.1	157	168	16.2	2 100	2 500	<b>6940</b>	211	269	2	7.30
	310	34	2	161	180	16.4	1 900	2 300	<b>16040</b>	209	301	2	10.1
	310	51	2.1	217	243	15.6	1 900	2 300	<b>6040</b>	211	299	2	14.0
	360	58	4	269	311	15.2	1 600	1 900	<b>6240</b>	216	344	3	28.2
	420	80	5	411	506	14.0	1 300	1 600	<b>6340</b>	220	400	4	58.0
<b>220</b>	270	24	1.5	80.7	101	16.0	2 000	2 400	<b>6844</b>	228	262	1.5	3.00
	300	38	2.1	160	180	16.4	1 900	2 200	<b>6944</b>	231	289	2	7.90
	340	37	2.1	180	217	16.5	1 700	2 000	<b>16044</b>	231	329	2	13.2
	340	56	3	235	271	15.6	1 700	2 000	<b>6044</b>	233	327	2.5	18.3
	400	65	4	311	376	15.1	1 400	1 700	<b>6244</b>	236	384	3	37.0
	460	88	5	433	539	13.8	1 200	1 500	<b>6344</b>	240	440	4	71.6
<b>240</b>	300	28	2	108	135	16.1	1 800	2 100	<b>6848</b>	249	291	2	4.50
	320	38	2.1	164	192	16.5	1 700	2 000	<b>6948</b>	251	309	2	8.50
	360	37	2.1	184	228	16.5	1 600	1 800	<b>16048</b>	251	349	2	14.1
	360	56	3	244	296	15.9	1 600	1 900	<b>6048</b>	253	347	2.5	19.7
	440	72	4	340	431	15.2	1 200	1 500	<b>6248</b>	256	424	3	51.0
	500	95	5	470	624	14.2	1 100	1 300	<b>6348</b>	260	480	4	93.3
<b>260</b>	320	28	2	112	146	16.0	1 700	2 000	<b>6852</b>	269	311	2	4.80
	360	46	2.1	213	263	16.3	1 500	1 800	<b>6952</b>	271	349	2	14.4
	400	44	3	236	310	16.4	1 400	1 600	<b>16052</b>	273	387	2.5	21.6
	400	65	4	291	377	15.8	1 400	1 700	<b>6052</b>	276	384	3	29.3
	480	80	5	402	541	15.1	1 100	1 300	<b>6252</b>	280	460	4	68.2
	540	102	6	531	741	14.2	990	1 200	<b>6352</b>	284	516	5	116
<b>280</b>	350	33	2	143	183	16.1	1 500	1 800	<b>6856</b>	289	341	2	7.40
	380	46	2.1	219	283	16.5	1 400	1 700	<b>6956</b>	291	369	2	15.1
	420	44	3	242	331	14.7	1 300	1 500	<b>16056</b>	293	407	2.5	22.9
	420	65	4	302	408	16.0	1 300	1 500	<b>6056</b>	296	404	3	31.0
	500	80	5	423	599	15.3	1 000	1 200	<b>6256</b>	300	480	4	71.8

[Remark] Standard cage types used for the above bearings are described earlier in this section.

$d$  (280) ~ (380) mm

Boundary dimensions (mm)				Basic load ratings (kN)		Factor $f_0$	Limiting speeds ( $\text{min}^{-1}$ )		Bearing No.	Mounting dimensions (mm)			(Refer.) Mass (kg)
$d$	$D$	$B$	$r_{\text{min}}$	$C_r$	$C_{0r}$		Grease lub.	Oil lub.		$d_a$ min.	$D_a$ max.	$r_a$ max.	
<b>280</b>	580	108	6	568	845	14.5	880	1 100	<b>6356</b>	304	556	5	145
<b>300</b>	380	38	2.1	179	230	16.2	1 400	1 600	<b>6860</b>	311	369	2	10.5
	420	56	3	276	377	16.2	1 300	1 500	<b>6960</b>	313	407	2.5	24.1
	460	50	4	284	405	16.4	1 100	1 400	<b>16060</b>	316	447	3	32.2
	460	74	4	355	482	15.6	1 200	1 400	<b>6060</b>	316	444	3	44.0
	540	85	5	441	663	15.6	880	1 100	<b>6260</b>	320	520	4	89.5
	620	109	7.5	593	886	14.4	810	970	<b>6360</b>	332	588	6	169
<b>320</b>	400	38	2.1	182	239	16.1	1 300	1 500	<b>6864</b>	331	389	2	11.0
	440	56	3	285	404	16.4	1 200	1 400	<b>6964</b>	333	427	2.5	25.5
	480	50	4	292	432	16.5	1 100	1 300	<b>16064</b>	336	467	3	33.9
	480	74	4	352	487	15.7	1 100	1 300	<b>6064</b>	336	464	3	46.0
	580	92	5	489	744	15.4	840	1 000	<b>6264</b>	340	560	4	113
	670	112	7.5	634	1 010	14.8	720	870	<b>6364</b>	352	638	6	207
<b>340</b>	420	38	2.1	185	249	16.1	1 200	1 400	<b>6868</b>	351	409	2	11.5
	460	56	3	282	407	16.5	1 100	1 300	<b>6968</b>	353	447	2.5	26.8
	520	57	4	335	512	16.4	980	1 200	<b>16068</b>	356	507	3	46.8
	520	82	5	441	661	15.6	980	1 200	<b>6068</b>	360	500	4	61.8
	620	92	6	511	817	15.6	760	910	<b>6268</b>	364	596	5	131
	710	118	7.5	704	1 160	14.7	660	790	<b>6368</b>	372	678	6	238
<b>360</b>	440	38	2.1	192	268	16.0	1 100	1 300	<b>6872</b>	371	429	2	12.0
	480	56	3	289	432	16.5	1 000	1 200	<b>6972</b>	373	467	2.5	28.2
	540	57	4	345	546	16.5	900	1 100	<b>16072</b>	376	527	3	49.0
	540	82	5	438	668	15.7	920	1 100	<b>6072</b>	380	520	4	64.7
	650	95	6	557	904	15.4	700	840	<b>6272</b>	384	626	5	144
	<b>380</b>	480	46	2.1	244	359	16.2	980	1 200	<b>6876</b>	391	469	2
520		65	4	352	552	16.4	920	1 100	<b>6976</b>	396	504	3	40.8
560		82	5	457	725	15.9	860	1 000	<b>6076</b>	400	540	4	67.6

# Single-row deep groove ball bearings open type

$d$  (380) ~ 500 mm

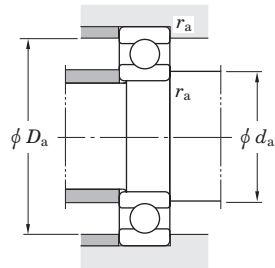
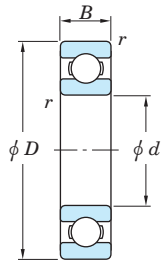

Boundary dimensions (mm)				Basic load ratings (kN)		Factor $f_0$	Limiting speeds ( $\text{min}^{-1}$ )		Bearing No.	Mounting dimensions (mm)			(Refer.) Mass (kg)
$d$	$D$	$B$	$r_{\text{min}}$	$C_r$	$C_{0r}$		Grease lub.	Oil lub.		$d_a$ min.	$D_a$ max.	$r_a$ max.	
<b>380</b>	680	95	6	584	990	15.6	650	780	<b>6276</b>	404	656	5	162
<b>400</b>	500	46	2.1	249	374	16.1	920	1 100	<b>6880</b>	411	489	2	20.5
	540	65	4	362	588	16.5	860	1 000	<b>6980</b>	416	524	3	42.7
	600	63	5	358	587	16.5	780	920	<b>16080</b>	420	580	4	65.0
	600	90	5	508	824	15.7	780	920	<b>6080</b>	420	580	4	87.7
	720	103	6	628	1 080	15.5	590	710	<b>6280</b>	424	696	5	197
<b>420</b>	520	46	2.1	253	389	16.1	860	1 000	<b>6884</b>	431	509	2	21.5
	560	65	4	359	588	16.5	810	950	<b>6984</b>	436	544	3	43.5
	620	63	5	367	617	16.4	740	870	<b>16084</b>	440	600	4	69.9
	620	90	5	530	894	15.8	740	870	<b>6084</b>	440	600	4	91.2
<b>440</b>	540	46	2.1	257	404	16.0	810	950	<b>6888</b>	451	529	2	22.5
	600	74	4	396	676	16.4	740	870	<b>6988</b>	456	584	3	61.3
	650	67	5	407	710	16.5	680	810	<b>16088</b>	460	630	4	81.7
<b>460</b>	580	56	3	314	517	16.2	740	870	<b>6892</b>	473	567	2.5	35.0
	620	74	4	407	711	16.5	690	820	<b>6992</b>	476	604	3	61.7
	680	71	5	431	767	16.5	630	750	<b>16092</b>	480	660	4	91.2
<b>480</b>	600	56	3	321	539	16.1	690	820	<b>6896</b>	493	587	2.5	36.5
	650	78	5	432	768	16.5	640	760	<b>6996</b>	500	630	4	72.5
	700	71	5	444	807	16.5	600	710	<b>16096</b>	500	680	4	98.5
<b>500</b>	620	56	3	327	561	16.1	650	770	<b>68/500</b>	513	607	2.5	37.5
	670	78	5	444	807	16.5	610	720	<b>69/500</b>	520	650	4	75.2
	720	71	5	455	846	16.4	560	660	<b>160/500</b>	520	700	4	102
	720	100	6	600	1 100	16.0	570	670	<b>60/500</b>	524	696	5	128

[Remark] Standard cage types used for the above bearings are described earlier in this section.

Single-row deep groove ball bearings  
shielded type  
sealed type

d 10 ~ (22) mm



Boundary dimensions (mm)				Basic load ratings (kN)		Factor $f_0$	Limiting speeds ( $\text{min}^{-1}$ )				Bearing No.				Mounting dimensions (mm)				(Refer.) Mass Open type (kg)
d	D	B	r min.	$C_r$	$C_{0r}$		Grease lub.		Oil lub.	Shielded		Non-contact sealed	Extremely light contact sealed	Contact sealed	d <sub>a</sub> min.	d <sub>a</sub> max.	D <sub>a</sub> max.	r <sub>a</sub> max.	
							[ Z, ZZ RU, 2RU ]	(RD, 2RD)	(RS, 2RS)	(Z)									
10	19	5	0.3	1.70	0.84	14.8	37 000	—	22 000	43 000	6800 ZZ	6800 2RU	—	6800 2RS	12	12	17	0.3	0.005
	22	6	0.3	2.70	1.25	14.0	34 000	—	21 000	41 000	6900 ZZ	6900 2RU	—	6900 2RS	12	12.5	20	0.3	0.010
	26	8	0.3	4.55	1.95	12.3	31 000	28 000	19 000	36 000	6000 ZZ	6000 2RU	6000 2RD	6000 2RS	12	13	24	0.3	0.019
	30	9	0.6	5.10	2.40	13.2	24 000	22 000	16 000	29 000	6200 ZZ	6200 2RU	6200 2RD	6200 2RS	14	15	26	0.6	0.032
	35	11	0.6	8.10	3.45	11.2	22 000	20 000	16 000	27 000	6300 ZZ	6300 2RU	6300 2RD	6300 2RS	14	16	31	0.6	0.053
12	21	5	0.3	1.90	1.05	15.3	33 000	30 000	20 000	39 000	6801 ZZ	6801 2RU	6801 2RD	6801 2RS	14	14	19	0.3	0.006
	24	6	0.3	2.90	1.45	14.5	31 000	28 000	18 000	36 000	6901 ZZ	6901 2RU	6901 2RD	6901 2RS	14	14	22	0.3	0.011
	28	8	0.3	5.10	2.40	13.2	27 000	24 000	17 000	32 000	6001 ZZ	6001 2RU	6001 2RD	6001 2RS	14	15	26	0.3	0.022
	32	10	0.6	6.80	3.05	12.3	22 000	20 000	15 000	27 000	6201 ZZ	6201 2RU	6201 2RD	6201 2RS	16	16.5	28	0.6	0.037
	37	12	1	9.70	4.20	11.1	20 000	18 000	15 000	25 000	6301 ZZ	6301 2RU	6301 2RD	6301 2RS	17	17.5	32	1	0.060
15	24	5	0.3	2.10	1.25	15.8	28 000	—	16 000	33 000	6802 ZZ	6802 2RU	—	6802 2RS	17	17	22	0.3	0.007
	28	7	0.3	4.30	2.25	14.3	26 000	23 000	15 000	30 000	6902 ZZ	6902 2RU	6902 2RD	6902 2RS	17	18	26	0.3	0.017
	32	9	0.3	5.60	2.85	13.9	23 000	21 000	14 000	27 000	6002 ZZ	6002 2RU	6002 2RD	6002 2RS	17	18.5	30	0.3	0.030
	35	11	0.6	7.65	3.75	13.2	20 000	18 000	13 000	24 000	6202 ZZ	6202 2RU	6202 2RD	6202 2RS	19	19.5	31	0.6	0.045
	42	13	1	11.4	5.45	12.3	17 000	15 000	12 000	20 000	6302 ZZ	6302 2RU	6302 2RD	6302 2RS	20	21.5	37	1	0.082
17	26	5	0.3	2.60	1.55	15.7	26 000	—	14 000	30 000	6803 ZZ	6803 2RU	—	6803 2RS	19	19	24	0.3	0.008
	30	7	0.3	4.60	2.55	14.7	23 000	21 000	13 000	28 000	6903 ZZ	6903 2RU	6903 2RD	6903 2RS	19	19.5	28	0.3	0.018
	35	10	0.3	6.00	3.25	14.4	21 000	19 000	12 000	25 000	6003 ZZ	6003 2RU	6003 2RD	6003 2RS	19	21	33	0.3	0.039
	40	12	0.6	9.55	4.80	13.2	17 000	15 000	12 000	21 000	6203 ZZ	6203 2RU	6203 2RD	6203 2RS	21	22	36	0.6	0.065
	47	14	1	13.6	6.65	12.4	15 000	14 000	10 000	18 000	6303 ZZ	6303 2RU	6303 2RD	6303 2RS	22	24.3	42	1	0.115
20	32	7	0.3	4.00	2.45	15.5	21 000	—	12 000	25 000	6804 ZZ	6804 2RU	—	6804 2RS	22	22.5	30	0.3	0.018
	37	9	0.3	6.35	3.70	14.7	19 000	17 000	11 000	23 000	6904 ZZ	6904 2RU	6904 2RD	6904 2RS	22	23.5	35	0.3	0.036
	42	12	0.6	9.40	5.05	13.9	17 000	15 000	10 000	21 000	6004 ZZ	6004 2RU	6004 2RD	6004 2RS	24	25	38	0.6	0.069
	47	14	1	12.8	6.65	13.2	15 000	14 000	9 700	17 000	6204 ZZ	6204 2RU	6204 2RD	6204 2RS	25	26.5	42	1	0.106
	52	15	1.1	15.9	7.85	12.3	14 000	13 000	9 500	17 000	6304 ZZ	6304 2RU	6304 2RD	6304 2RS	26.5	27	45.5	1	0.144
22	44	12	0.6	9.40	5.15	14.1	17 000	15 000	9 900	20 000	60/22 ZZ	60/22 2RU	60/22 2RD	60/22 2RS	26	26.5	40	0.6	0.073
	50	14	1	12.8	6.65	13.2	15 000	14 000	9 700	17 000	62/22 ZZ	62/22 2RU	62/22 2RD	62/22 2RS	27	27	45	1	0.118

[Remark] Standard cage types used for the above bearings are described earlier in this section.

Single-row deep groove ball bearings  
shielded type  
sealed type

d (22) ~ 40 mm



Boundary dimensions (mm)				Basic load ratings (kN)		Factor	Limiting speeds (min <sup>-1</sup> )				Bearing No.				Mounting dimensions (mm)				(Refer.) Mass Open type (kg)
d	D	B	r min.	C <sub>r</sub>	C <sub>0r</sub>		Grease lub.		Oil lub.		Shielded	Non-contact sealed	Extremely light contact sealed	Contact sealed	d <sub>a</sub> min.	d <sub>a</sub> max.	D <sub>a</sub> max.	r <sub>a</sub> max.	
22	56	16	1.1	18.5	9.40	12.6	13 000	12 000	8 600	15 000	63/22 ZZ	63/22 2RU	63/22 2RD	63/22 2RS	28.5	29	49.5	1	0.201
25	37	7	0.3	4.30	2.95	16.0	18 000	—	10 000	21 000	6805 ZZ	6805 2RU	—	6805 2RS	27	27.5	35	0.3	0.022
	42	9	0.3	7.00	4.55	15.4	16 000	14 000	9 300	19 000	6905 ZZ	6905 2RU	6905 2RD	6905 2RS	27	29	40	0.3	0.041
	47	12	0.6	10.1	5.85	14.5	15 000	14 000	9 000	18 000	6005 ZZ	6005 2RU	6005 2RD	6005 2RS	29	29.5	43	0.6	0.080
	52	15	1	14.0	7.85	13.9	13 000	12 000	8 400	15 000	6205 ZZ	6205 2RU	6205 2RD	6205 2RS	30	31.5	47	1	0.128
	62	17	1.1	20.6	11.3	13.2	11 000	9 900	7 500	13 000	6305 ZZ	6305 2RU	6305 2RD	6305 2RS	31.5	34	55.5	1	0.232
28	52	12	0.6	12.4	7.40	14.5	14 000	13 000	8 100	16 000	60/28 ZZ	60/28 2RU	60/28 2RD	60/28 2RS1	32	33	48	0.6	0.097
	58	16	1	17.9	9.75	13.4	12 000	11 000	7 600	14 000	62/28 ZZ	62/28 2RU	62/28 2RD	62/28 2RS	33	35	53	1	0.173
	68	18	1.1	23.5	13.1	13.3	10 000	9 000	6 900	12 000	63/28 ZZ	63/28 2RU	63/28 2RD	63/28 2RS	34.5	37.5	61.5	1	0.328
30	42	7	0.3	4.55	3.40	16.4	15 000	—	8 600	18 000	6806 ZZ	6806 2RU	—	6806 2RS	32	32.5	40	0.3	0.026
	47	9	0.3	7.25	5.00	15.8	14 000	13 000	8 200	17 000	6906 ZZ	6906 2RU	6906 2RD	6906 2RS	32	33	45	0.3	0.045
	55	13	1	13.2	8.25	14.7	13 000	12 000	7 500	15 000	6006 ZZ	6006 2RU	6006 2RD	6006 2RS	35	36	50	1	0.116
	62	16	1	19.5	11.3	13.9	11 000	9 900	7 000	13 000	6206 ZZ	6206 2RU	6206 2RD	6206 2RS	35	37.5	57	1	0.199
	72	19	1.1	26.7	15.0	13.3	9 600	8 600	6 400	12 000	6306 ZZ	6306 2RU	6306 2RD	6306 2RS	36.5	40	65.5	1	0.346
32	58	13	1	15.0	9.15	14.5	12 000	11 000	7 200	14 000	60/32 ZZ	60/32 2RU	60/32 2RD	60/32 2RS	37	38	53	1	0.127
	65	17	1	23.5	13.1	13.3	10 000	9 000	6 900	12 000	62/32 ZZ	62/32 2RU	62/32 2RD	62/32 2RS	37	38.5	60	1	0.228
	75	20	1.1	30.1	16.2	12.7	9 300	8 400	6 400	11 000	63/32 ZZ	63/32 2RU	63/32 2RD	63/32 2RS	38.5	41	68.5	1	0.437
35	47	7	0.3	4.75	3.85	16.5	13 000	—	7 400	16 000	6807 ZZ	6807 2RU	—	6807 2RS	37	37.5	45	0.3	0.030
	55	10	0.6	10.9	7.75	15.7	12 000	11 000	6 800	14 000	6907 ZZ	6907 2RU	6907 2RD	6907 2RS	39	40	51	0.6	0.073
	62	14	1	15.9	10.3	14.9	11 000	9 900	6 500	13 000	6007 ZZ	6007 2RU	6007 2RD	6007 2RS	40	42	58	1	0.155
	72	17	1.1	25.7	15.4	13.9	9 200	8 300	6 000	11 000	6207 ZZ	6207 2RU	6207 2RD	6207 2RS	41.5	43.5	65.5	1	0.288
	80	21	1.5	33.4	19.3	13.2	8 500	7 700	5 700	10 000	6307 ZZ	6307 2RU	6307 2RD	6307 2RS	43	46	72	1.5	0.457
40	52	7	0.3	4.95	4.20	16.3	12 000	11 000	6 700	14 000	6808 ZZ	6808 2RU	6808 2RD	6808 2RS	42	42	50	0.3	0.033
	62	12	0.6	13.7	9.95	15.6	11 000	9 900	6 100	13 000	6908 ZZ	6908 2RU	6908 2RD	6908 2RS	44	44.5	58	0.6	0.112
	68	15	1	16.7	11.5	15.2	10 000	9 000	5 800	12 000	6008 ZZ	6008 2RU	6008 2RD	6008 2RS	45	46.5	63	1	0.192
	80	18	1.1	29.1	17.8	14.0	8 300	7 500	5 400	10 000	6208 ZZ	6208 2RU	6208 2RD	6208 2RS	46.5	49	73.5	1	0.366
	90	23	1.5	40.7	24.0	13.2	7 700	6 900	5 100	9 200	6308 ZZ	6308 2RU	6308 2RD	6308 2RS	48	51.5	82	1.5	0.633

[Remark] Standard cage types used for the above bearings are described earlier in this section.

Single-row deep groove ball bearings  
shielded type  
sealed type

d 45 ~ (70) mm



Boundary dimensions (mm)				Basic load ratings (kN)		Factor $f_0$	Limiting speeds ( $\text{min}^{-1}$ )				Bearing No.				Mounting dimensions (mm)				(Refer.) Mass Open type (kg)
$d$	$D$	$B$	$r_{\text{min}}$	$C_r$	$C_{0r}$		Grease lub.		Oil lub.	Shielded	Non-contact sealed	Extremely light contact sealed	Contact sealed	$d_a$ min.	$d_a$ max.	$D_a$ max.	$r_a$ max.		
							[ Z, ZZ RU, 2RU ]	(RD, 2RD)	(RS, 2RS)	(Z)									
45	58	7	0.3	6.20	5.40	16.3	11 000	9 900	5 900	13 000	6809 ZZ	6809 2RU	6809 2RD	6809 2RS	47	47	56	0.3	0.040
	68	12	0.6	14.1	10.9	15.9	9 700	8 700	5 500	11 000	6909 ZZ	6909 2RU	6909 2RD	6909 2RS	49	50	64	0.6	0.132
	75	16	1	21.0	15.1	15.3	9 200	8 300	5 300	11 000	6009 ZZ	6009 2RU	6009 2RD	6009 2RS	50	51.5	70	1	0.245
	85	19	1.1	32.7	20.3	14.0	7 700	6 900	5 100	9 200	6209 ZZ	6209 2RU	6209 2RD	6209 2RS	51.5	53.5	78.5	1	0.407
	100	25	1.5	48.9	29.5	13.3	6 800	6 100	4 500	8 100	6309 ZZ	6309 2RU	6309 2RD	6309 2RS	53	59.5	92	1.5	0.833
50	65	7	0.3	6.60	6.10	16.1	9 600	8 600	5 200	11 000	6810 ZZ	6810 2RU	6810 2RD	6810 2RS	52	53	63	0.3	0.052
	72	12	0.6	14.5	11.7	16.1	9 000	—	5 000	11 000	6910 ZZ	6910 2RU	—	—	54	55.5	68	0.6	0.133
	80	16	1	21.8	16.6	15.6	8 400	7 600	4 800	9 900	6010 ZZ	6010 2RU	6010 2RD	6010 2RS	55	57	75	1	0.261
	90	20	1.1	35.1	23.3	14.4	7 100	6 400	4 600	8 500	6210 ZZ	6210 2RU	6210 2RD	6210 2RS	56.5	59	83.5	1	0.463
	110	27	2	62.0	38.3	13.2	6 100	5 500	4 100	7 300	6310 ZZ	6310 2RU	6310 2RD	6310 2RS	59	66.5	101	2	1.07
55	72	9	0.3	8.80	8.10	16.2	8 700	7 800	—	10 000	6811 ZZ	6811 2RU	6811 2RD	—	57	58.5	70	0.3	0.083
	80	13	1	16.6	14.1	16.2	8 100	7 300	4 500	9 600	6911 ZZ	6911 2RU	6911 2RD	6911 2RS	60	60.5	75	1	0.185
	90	18	1.1	28.3	21.2	15.3	7 600	6 800	4 300	8 900	6011 ZZ	6011 2RU	6011 2RD	6011 2RS	61.5	62	83.5	1	0.385
	100	21	1.5	43.4	29.4	14.4	6 300	5 700	4 100	7 600	6211 ZZ	6211 2RU	6211 2RD	6211 2RS	63	66	92	1.5	0.607
	120	29	2	71.6	45.0	13.2	5 600	—	3 700	6 700	6311 ZZ	6311 2RU	—	6311 2RS	64	74.5	111	2	1.37
60	78	10	0.3	11.5	10.6	16.3	8 000	7 200	—	9 400	6812 ZZ	6812 2RU	6812 2RD	—	62	63	76	0.3	0.104
	85	13	1	20.2	17.3	16.2	7 500	—	—	8 900	6912 ZZ	6912 2RU	—	—	65	66	80	1	0.192
	95	18	1.1	29.4	23.2	15.6	7 100	—	4 000	8 400	6012 ZZ	6012 2RU	—	6012 2RS	66.5	68.5	88.5	1	0.415
	110	22	1.5	52.4	36.2	14.4	5 700	5 100	3 700	6 900	6212 ZZ	6212 2RU	6212 2RD	6212 2RS	68	72.5	102	1.5	0.783
	130	31	2.1	81.9	52.2	13.2	5 200	—	3 500	6 200	6312 ZZ	6312 2RU	—	6312 2RS	71	80	119	2	1.70
65	85	10	0.6	11.9	11.5	16.2	7 300	6 600	—	8 600	6813 ZZ	6813 2RU	6813 2RD	—	69	69	81	0.6	0.126
	90	13	1	17.4	16.1	16.6	7 100	6 400	3 900	8 400	6913 ZZ	6913 2RU	6913 2RD	6913 2RS	70	71	85	1	0.211
	100	18	1.1	30.5	25.2	15.8	6 600	—	3 700	7 800	6013 ZZ	6013 2RU	—	6013 2RS	71.5	74.5	93.5	1	0.435
	120	23	1.5	57.2	40.1	14.4	5 400	—	3 500	6 400	6213 ZZ	6213 2RU	—	6213 2RS	73	79	112	1.5	0.990
	140	33	2.1	92.7	59.9	13.2	4 800	—	3 200	5 800	6313 ZZ	6313 2RU	—	6313 2RS	76	86	129	2	2.08
70	90	10	0.6	12.1	11.9	16.1	6 800	6 100	—	8 100	6814 ZZ	6814 2RU	6814 2RD	—	74	74	86	0.6	0.134
	100	16	1	23.7	21.2	16.3	6 400	5 800	3 600	7 600	6914 ZZ	6914 2RU	6914 2RD	6914 2RS	75	76.5	95	1	0.342

[Remark] Standard cage types used for the above bearings are described earlier in this section.

Single-row deep groove ball bearings  
shielded type  
sealed type

$d$  (70) ~ 95 mm



Boundary dimensions (mm)				Basic load ratings (kN)		Factor $f_0$	Limiting speeds ( $\text{min}^{-1}$ )				Bearing No.				Mounting dimensions (mm)				(Refer.) Mass Open type (kg)
$d$	$D$	$B$	$r$ min.	$C_r$	$C_{0r}$		Grease lub.		Oil lub.	Shielded		Non-contact sealed	Extremely light contact sealed	Contact sealed	$d_a$ min.	$d_a$ max.	$D_a$ max.	$r_a$ max.	
70	110	20	1.1	38.1	30.9	15.6	6 100	—	3 500	7 200	6014 ZZ	6014 2RU	—	6014 2RS	76.5	79.5	103.5	1	0.602
	125	24	1.5	62.2	44.1	14.5	5 100	—	3 300	6 100	6214 ZZ	6214 2RU	—	6214 2RS	78	84	117	1.5	1.07
	150	35	2.1	104	68.2	13.2	4 500	—	3 000	5 400	6314 ZZ	6314 2RU	—	6314 2RS	81	92	139	2	2.52
75	95	10	0.6	12.5	12.9	16.0	6 400	5 800	—	7 600	6815 ZZ	6815 2RU	6815 2RD	—	79	79	91	0.6	0.142
	105	16	1	24.4	22.6	16.5	6 100	—	—	7 200	6915 ZZ	6915 2RU	—	—	80	82.5	100	1	0.363
	115	20	1.1	39.6	33.5	15.8	5 700	—	3 300	6 800	6015 ZZ	6015 2RU	—	6015 2RS	81.5	84.5	108.5	1	0.638
	130	25	1.5	67.4	48.3	14.5	4 800	—	3 100	5 800	6215 ZZ	6215 2RU	—	6215 2RS	83	88.5	122	1.5	1.18
	160	37	2.1	113	77.2	13.2	4 200	—	2 800	5 000	6315 ZZ	6315 2RU	—	6315 2RS	86	97.5	149	2	3.02
80	100	10	0.6	12.7	13.3	16.0	6 100	5 500	—	7 200	6816 ZZ	6816 2RU	6816 2RD	—	84	84	96	0.6	0.150
	110	16	1	25.0	24.0	16.6	5 700	5 100	3 200	6 800	6916 ZZ	6916 2RU	6916 2RD	6916 2RS	85	86.5	105	1	0.382
	125	22	1.1	47.6	39.8	15.6	5 300	—	3 100	6 300	6016 ZZ	6016 2RU	—	6016 2RS	86.5	90	118.5	1	0.850
	140	26	2	72.7	53.0	14.6	4 500	—	2 900	5 400	6216 ZZ	6216 2RU	—	6216 2RS	89	93	131	2	1.40
	170	39	2.1	123	86.7	13.3	3 900	—	2 700	4 700	6316 ZZ	6316 2RU	—	6316 2RS	91	105	159	2	3.59
85	110	13	1	18.7	19.0	16.2	5 600	5 000	—	6 600	6817 ZZ	6817 2RU	6817 2RD	—	90	90.5	105	1	0.266
	120	18	1.1	31.9	29.6	16.4	5 300	4 800	3 000	6 300	6917 ZZ	6917 2RU	6917 2RD	6917 2RS	91.5	92.5	113.5	1	0.535
	130	22	1.1	49.5	43.1	15.8	5 000	—	2 900	5 900	6017 ZZ	6017 2RU	—	6017 2RS	91.5	96.5	123.5	1	0.890
	150	28	2	84.0	61.9	14.5	4 200	—	2 700	5 000	6217 ZZ	6217 2RU	—	6217 2RS	94	102	141	2	1.79
	180	41	3	133	96.8	13.3	3 700	—	2 500	4 400	6317 ZZ	6317 2RU	—	6317 2RS	98	111	167	2.5	4.23
90	115	13	1	19.0	19.7	16.1	5 300	4 800	—	6 300	6818 ZZ	6818 2RU	6818 2RD	—	95	95.5	110	1	0.279
	125	18	1.1	32.8	31.6	16.5	5 100	4 600	2 800	6 000	6918 ZZ	6918 2RU	6918 2RD	6918 2RS	96.5	97.5	118.5	1	0.565
	140	24	1.5	58.2	49.7	15.6	4 700	—	2 700	5 600	6018 ZZ	6018 2RU	—	6018 2RS	98	100.5	132	1.5	1.16
	160	30	2	96.1	71.5	14.5	3 900	—	2 600	4 700	6218 ZZ	6218 2RU	—	6218 2RS	99	108.5	151	2	2.15
	190	43	3	143	107	13.3	3 500	—	2 400	4 200	6318 ZZ	6318 2RU	—	6318 2RS	103	117	177	2.5	4.91
95	130	18	1.1	33.7	33.5	16.6	4 800	4 300	2 700	5 700	6919 ZZ	6919 2RU	6919 2RD	6919 2RS	101.5	102	123.5	1	0.705
	145	24	1.5	60.4	53.9	15.8	4 400	—	2 500	5 200	6019 ZZ	6019 2RU	—	6019 2RS	103	107.5	137	1.5	1.21
	170	32	2.1	109	81.9	14.4	3 700	—	2 400	4 400	6219 ZZ	6219 2RU	—	6219 2RS	106	113	159	2	2.62
	200	45	3	153	119	13.3	3 300	—	2 200	4 000	6319 ZZ	6319 2RU	—	6319 2RS	108	122	187	2.5	5.67

[Remark] Standard cage types used for the above bearings are described earlier in this section.

Single-row deep groove ball bearings  
shielded type  
sealed type

d 100 ~ (140) mm



Boundary dimensions (mm)				Basic load ratings (kN)		Factor $f_0$	Limiting speeds ( $\text{min}^{-1}$ )				Bearing No.				Mounting dimensions (mm)				(Refer.) Mass Open type (kg)
$d$	$D$	$B$	$r_{\text{min}}$	$C_r$	$C_{0r}$		Grease lub.		Oil lub.		Shielded	Non-contact sealed	Extremely light contact sealed	Contact sealed	$d_a$ min.	$d_a$ max.	$D_a$ max.	$r_a$ max.	
							$\left\{ \begin{matrix} Z, ZZ \\ RU, 2RU \end{matrix} \right\}$	(RD, 2RD)	(RS, 2RS)	(Z)									
<b>100</b>	125	13	1	19.6	21.2	16.0	4 800	4 300	—	5 700	<b>6820 ZZ</b>	<b>6820 2RU</b>	<b>6820 2RD</b>	—	105	105.5	120	1	0.309
	140	20	1.1	45.0	41.9	16.2	4 500	—	—	5 300	<b>6920-1 ZZ</b>	<b>6920-1 2RU</b>	—	—	106.5	110.5	133.5	1	0.960
	150	24	1.5	60.2	54.2	15.9	4 300	—	2 500	5 100	<b>6020 ZZ</b>	<b>6020 2RU</b>	—	<b>6020 2RS</b>	108	112	142	1.5	1.25
	180	34	2.1	122	93.1	14.4	3 500	—	2 300	4 200	<b>6220 ZZX</b>	<b>6220 2RU</b>	—	<b>6220 2RS</b>	111	122	169	2	3.14
	215	47	3	173	141	13.2	3 000	—	2 100	3 600	<b>6320 ZZX</b>	<b>6320 2RU</b>	—	<b>6320 2RS</b>	113	131	202	2.5	7.00
<b>105</b>	145	20	1.1	46.5	44.8	16.4	4 300	—	2 400	5 100	<b>6921-1 ZZ</b>	<b>6921-1 2RU</b>	—	<b>6921-1 2RS</b>	111.5	115	138.5	1	1.00
	160	26	2	72.3	65.8	15.8	4 000	—	2 300	4 700	<b>6021 ZZX</b>	<b>6021 2RU</b>	—	<b>6021 2RS</b>	114	119	151	2	1.59
	190	36	2.1	133	105	14.4	3 300	—	2 200	3 900	<b>6221 ZZX</b>	<b>6221 2RU</b>	—	<b>6221 2RS</b>	116	127	179	2	3.70
	225	49	3	184	153	13.2	2 900	—	2 000	3 500	<b>6321 ZZX</b>	<b>6321 2RU</b>	—	<b>6321 2RS</b>	118	136	212	2.5	8.05
<b>110</b>	140	16	1	28.1	30.7	16.1	4 300	3 900	—	5 100	<b>6822 ZZ</b>	<b>6822 2RU</b>	<b>6822 2RD</b>	—	115	116.5	135	1	0.606
	150	20	1.1	47.9	47.8	16.4	4 100	—	—	4 900	<b>6922 ZZ</b>	<b>6922 2RU</b>	—	—	116.5	119.5	143.5	1	1.04
	170	28	2	82.0	73.0	15.6	3 800	—	2 200	4 500	<b>6022 ZZX</b>	<b>6022 2RU</b>	—	<b>6022 2RS</b>	119	123	161	2	1.96
	200	38	2.1	144	117	14.4	3 100	—	2 000	3 700	<b>6222 ZZX</b>	<b>6222 2RU</b>	—	<b>6222 2RS</b>	121	136.5	189	2	4.36
	240	50	3	205	180	13.2	2 700	—	1 900	3 200	<b>6322 ZZX</b>	<b>6322 2RU</b>	—	<b>6322 2RS</b>	123	146.5	227	2.5	9.54
<b>120</b>	150	16	1	29.0	33.0	16.0	4 000	—	—	4 700	<b>6824 ZZ</b>	<b>6824 2RU</b>	—	—	125	128.5	145	1	0.655
	165	22	1.1	57.2	56.9	16.4	3 800	—	—	4 400	<b>6924 ZZ</b>	<b>6924 2RU</b>	—	—	126.5	131.5	158.5	1	1.41
	180	28	2	85.0	79.3	15.9	3 600	—	2 100	4 200	<b>6024 ZZX</b>	<b>6024 2RU</b>	—	<b>6024 2RS</b>	129	136	171	2	2.07
	215	40	2.1	155	131	14.4	2 900	—	1 900	3 400	<b>6224 ZZX</b>	<b>6224 2RU</b>	—	<b>6224 2RS</b>	131	144	204	2	5.15
	260	55	3	207	185	13.5	2 500	—	—	3 000	<b>6324 ZZX</b>	—	—	—	133	158	247	2.5	12.5
<b>130</b>	165	18	1.1	36.9	41.2	16.1	3 600	—	—	4 300	<b>6826 ZZ</b>	<b>6826 2RU</b>	—	—	136.5	139.5	158.5	1	0.939
	180	24	1.5	65.2	67.4	16.3	3 400	—	—	4 100	<b>6926-1 ZZ</b>	<b>6926-1 2RU</b>	—	—	138	144	172	1.5	1.86
	200	33	2	106	101	15.8	3 200	—	1 900	3 800	<b>6026 ZZX</b>	<b>6026 2RU</b>	—	<b>6026 2RS</b>	139	146.5	191	2	3.16
	230	40	3	167	146	14.5	2 700	—	1 800	3 200	<b>6226 ZZX</b>	<b>6226 2RU</b>	—	<b>6226 2RS</b>	143	157	217	2.5	5.82
	280	58	4	229	214	13.6	2 300	—	—	2 700	<b>6326 ZZX</b>	—	—	—	146	171	264	3	15.1
<b>140</b>	175	18	1.1	38.2	44.4	16.0	3 400	3 100	—	4 000	<b>6828 ZZ</b>	—	<b>6828 2RD</b>	—	146.5	148	168.5	1	1.00
	190	24	1.5	71.3	74.8	16.5	3 200	—	—	3 800	<b>6928-1 ZZ</b>	<b>6928-1 2RU</b>	—	—	148	153	182	1.5	1.98
	210	33	2	110	109	15.9	3 000	—	1 800	3 600	<b>6028 ZZX</b>	<b>6028 2RU</b>	—	<b>6028 2RS</b>	149	158.5	201	2	3.55

[Remark] Standard cage types used for the above bearings are described earlier in this section.



**Single-row deep groove ball bearings**  
**shielded type**  
**sealed type**

$d$  (140) ~ 220 mm



Boundary dimensions (mm)				Basic load ratings (kN)		Factor $f_0$	Limiting speeds ( $\text{min}^{-1}$ )				Bearing No.				Mounting dimensions (mm)				(Refer.) Mass Open type (kg)
$d$	$D$	$B$	$r_{\text{min}}$	$C_r$	$C_{0r}$		Grease lub.		Oil lub.	Shielded		Non-contact sealed	Extremely light contact sealed	Contact sealed	$d_a$ min.	$d_a$ max.	$D_a$ max.	$r_a$ max.	
							[ Z, ZZ RU, 2RU ]	(RD, 2RD)	(RS, 2RS)	(Z)									
<b>140</b>	250	42	3	166	150	14.8	2 400	—	1 600	2 900	<b>6228 ZZ</b>	<b>6228 2RU</b>	—	<b>6228 2RS</b>	153	169	237	2.5	7.45
	300	62	4	253	246	13.6	2 100	—	—	2 500	<b>6328 ZZ</b>	—	—	—	156	184	284	3	19.4
<b>150</b>	210	28	2	93.4	94.3	16.2	2 900	—	1 700	3 400	<b>6930 ZZ</b>	<b>6930 2RU</b>	—	<b>6930 2RS</b>	159	165.5	201	2	3.05
	225	35	2.1	125	126	16.0	2 800	—	1 600	3 300	<b>6030 ZZ</b>	<b>6030 2RU</b>	—	<b>6030 2RS</b>	161	168.5	214	2	4.22
	270	45	3	176	168	15.1	2 200	—	—	2 700	<b>6230 ZZ</b>	—	—	—	163	183.5	257	2.5	9.41
<b>160</b>	200	20	1.1	48.4	56.9	16.1	2 900	2 600	—	3 400	<b>6832 ZZ</b>	—	<b>6832 2RD</b>	—	166.5	168.5	193.5	1	1.45
	240	38	2.1	136	135	15.9	2 600	—	1 500	3 000	<b>6032 ZZ</b>	<b>6032 2RU</b>	—	<b>6032 2RS</b>	171	178.5	229	2	5.22
	290	48	3	185	186	15.4	2 100	—	—	2 500	<b>6232 ZZ</b>	—	—	—	173	198	277	2.5	14.3
<b>170</b>	215	22	1.1	59.8	70.5	16.1	2 700	—	—	3 200	<b>6834 ZZ</b>	—	—	—	176.5	182.5	208.5	1	1.90
	260	42	2.1	161	161	15.8	2 400	—	—	2 800	<b>6034 ZZ</b>	<b>6034 2RU</b>	—	—	181	194	249	2	6.80
	310	52	4	212	223	15.3	1 900	—	—	2 300	<b>6234 ZZ</b>	—	—	—	186	210.5	294	3	17.5
<b>180</b>	225	22	1.1	60.7	73.1	16.1	2 600	2 300	—	3 000	<b>6836 ZZ</b>	—	<b>6836 2RD</b>	—	186.5	189.5	218.5	1	2.00
	280	46	2.1	182	194	15.8	2 200	—	—	2 600	<b>6036 ZZ</b>	<b>6036 2RU</b>	—	—	191	209.5	269	2	10.3
	320	52	4	227	241	15.1	1 800	—	—	2 200	<b>6236-1 ZZ</b>	—	—	—	196	220.5	304	3	18.3
<b>190</b>	240	24	1.5	73.1	88.1	16.1	2 400	—	—	2 800	<b>6838 ZZ</b>	—	—	—	198	202	232	1.5	2.60
	290	46	2.1	188	201	15.8	2 100	—	—	2 500	<b>6038 ZZ</b>	—	—	—	201	215	279	2	10.8
<b>200</b>	310	51	2.1	217	243	15.6	1 900	—	—	2 300	<b>6040 ZZ</b>	—	—	—	211	228	299	2	14.0
	360	58	4	269	311	15.2	1 600	—	—	1 900	<b>6240-1 ZZ</b>	—	—	—	216	250	344	3	28.2
<b>220</b>	340	56	3	235	271	15.6	1 700	—	—	2 000	<b>6044 ZZ</b>	—	—	—	233	251	327	2.5	18.3

[Remark] Standard cage types used for the above bearings are described earlier in this section.

Single-row deep groove ball bearings  
snap ring groove type  
locating snap ring type

$d$  10 ~ 32 mm

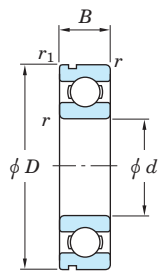

N  
With snap ring groove

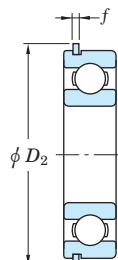

NR  
With locating snap ring

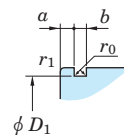

Snap ring groove details

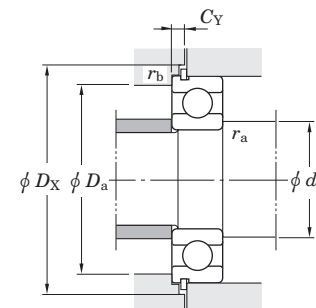

With locating snap ring and one shield

Boundary dimensions (mm)					Basic load ratings (kN)		Factor $f_0$	Limiting speeds ( $\text{min}^{-1}$ )		Bearing No.		$D_1$ max.	Dimensions of snap ring groove (mm)			Dimensions of locating snap ring (mm)		Mounting dimensions (mm)						(Refer.) Mass (kg)	(Refer.) Bearing No.
$d$	$D$	$B$	$r_{\text{min}}$	$r_{1\text{min}}$	$C_r$	$C_{0r}$		Grease lub.	Oil lub.	With snap ring groove	With locating snap ring		$a$ max.	$b$ $\pm 0.15$	$r_0$ max.	$D_2$ max.	$f$ $\pm 0.05$	$d_a$ min.	$D_a$ max.	$D_X$ min.	$C_Y$ max.	$r_a$ max.	$r_b$ max.		
10	30	9	0.6	0.3	5.10	2.40	13.2	24 000	29 000	6200N	6200NR	28.17	2.06	1.5	0.4	34.7	1.07	14	26	35.5	2.92	0.6	0.3	0.032	6200N
	35	11	0.6	0.5	8.10	3.45	11.2	22 000	27 000	6300N	6300NR	33.17	2.06	1.5	0.4	39.7	1.07	14	31	40.5	2.92	0.6	0.5	0.053	6300N
12	32	10	0.6	0.3	6.80	3.05	12.3	22 000	27 000	6201N	6201NR	30.15	2.06	1.5	0.4	36.7	1.07	16	28	37.5	2.92	0.6	0.3	0.037	6201N
	37	12	1	0.5	9.70	4.20	11.1	20 000	25 000	6301N	6301NR	34.77	2.06	1.5	0.4	41.3	1.07	17	32	42	2.92	1	0.5	0.060	6301N
15	35	11	0.6	0.5	7.65	3.75	13.2	20 000	24 000	6202N	6202NR	33.17	2.06	1.5	0.4	39.7	1.07	19	31	40.5	2.92	0.6	0.5	0.045	6202N
	42	13	1	0.5	11.4	5.45	12.3	17 000	20 000	6302N	6302NR	39.75	2.06	1.5	0.4	46.3	1.07	20	37	47	2.92	1	0.5	0.082	6302N
17	40	12	0.6	0.5	9.55	4.80	13.2	17 000	21 000	6203N	6203NR	38.1	2.06	1.5	0.4	44.6	1.07	21	36	45.5	2.92	0.6	0.5	0.065	6203N
	47	14	1	0.5	13.6	6.65	12.4	15 000	18 000	6303N	6303NR	44.6	2.46	1.5	0.4	52.7	1.07	22	42	53.5	3.33	1	0.5	0.115	6303N
20	42	12	0.6	0.5	9.40	5.05	13.9	17 000	21 000	6004N	6004NR	39.75	2.06	1.5	0.4	46.3	1.07	24	38	47	2.92	0.6	0.5	0.069	6004N
	47	14	1	0.5	12.8	6.65	13.2	15 000	17 000	6204N	6204NR	44.6	2.46	1.5	0.4	52.7	1.07	25	42	53.5	3.33	1	0.5	0.106	6204N
	52	15	1.1	0.5	15.9	7.85	12.3	14 000	17 000	6304N	6304NR	49.73	2.46	1.5	0.4	57.9	1.07	26.5	45.5	58.5	3.33	1	0.5	0.144	6304N
22	44	12	0.6	0.5	9.40	5.15	14.1	17 000	20 000	60/22N	60/22NR	41.75	2.06	1.5	0.4	48.3	1.07	26	40	49	2.92	0.6	0.5	0.073	60/22N
	50	14	1	0.5	12.8	6.65	13.2	15 000	17 000	62/22N	62/22NR	47.6	2.46	1.5	0.4	55.7	1.07	27	45	56.5	3.33	1	0.5	0.118	62/22N
	56	16	1.1	0.5	18.5	9.40	12.6	13 000	15 000	63/22N	63/22NR	53.6	2.46	1.5	0.4	61.7	1.07	28.5	49.5	62.5	3.33	1	0.5	0.201	63/22N
25	47	12	0.6	0.5	10.1	5.85	14.5	15 000	18 000	6005N	6005NR	44.6	2.06	1.5	0.4	52.7	1.07	29	43	53.5	2.92	0.6	0.5	0.080	6005N
	52	15	1	0.5	14.0	7.85	13.9	13 000	15 000	6205N	6205NR	49.73	2.46	1.5	0.4	57.9	1.07	30	47	58.5	3.33	1	0.5	0.128	6205N
	62	17	1.1	0.5	20.6	11.3	13.2	11 000	13 000	6305N	6305NR	59.61	3.28	2.05	0.6	67.7	1.65	31.5	55.5	68.5	4.67	1	0.5	0.232	6305N
28	52	12	0.6	0.5	12.4	7.40	14.5	14 000	16 000	60/28N	60/28NR	49.73	2.06	1.5	0.4	57.9	1.07	32	48	58.5	2.92	0.6	0.5	0.097	60/28N
	58	16	1	0.5	17.9	9.75	13.4	12 000	14 000	62/28N	62/28NR	55.6	2.46	1.5	0.4	63.7	1.07	33	53	64.5	3.33	1	0.5	0.173	62/28N
	68	18	1.1	0.5	23.5	13.1	13.3	10 000	12 000	63/28N	63/28NR	64.82	3.28	2.05	0.6	74.6	1.65	34.5	61.5	76	4.67	1	0.5	0.328	63/28N
30	55	13	1	0.5	13.2	8.25	14.7	13 000	15 000	6006N	6006NR	52.6	2.08	1.5	0.4	60.7	1.07	35	50	61.5	2.9	1	0.5	0.116	6006N
	62	16	1	0.5	19.5	11.3	13.9	11 000	13 000	6206N	6206NR	59.61	3.28	2.05	0.6	67.7	1.65	35	57	68.5	4.67	1	0.5	0.199	6206N
	72	19	1.1	0.5	26.7	15.0	13.3	9 600	12 000	6306N	6306NR	68.81	3.28	2.05	0.6	78.6	1.65	36.5	65.5	80	4.67	1	0.5	0.346	6306N
32	58	13	1	0.5	15.0	9.15	14.5	12 000	14 000	60/32N	60/32NR	55.6	2.08	1.5	0.4	63.7	1.07	37	53	64.5	2.9	1	0.5	0.127	60/32N
	65	17	1	0.5	23.5	13.1	13.3	10 000	12 000	62/32N	62/32NR	62.6	3.28	2.05	0.6	70.7	1.65	37	60	71.5	4.67	1	0.5	0.228	62/32N
	75	20	1.1	0.5	30.1	16.2	12.7	9 300	11 000	63/32N	63/32NR	71.83	3.28	2.05	0.6	81.6	1.65	38.5	68.5	83	4.67	1	0.5	0.437	63/32N

[Remark] Standard cage types used for the above bearings are described earlier in this section.

Single-row deep groove ball bearings  
snap ring groove type  
locating snap ring type

d 35 ~ 75 mm

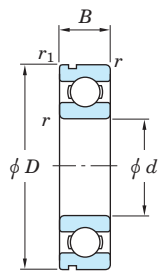

N  
With snap ring groove

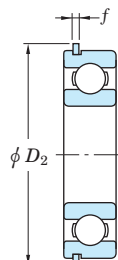

NR  
With locating snap ring

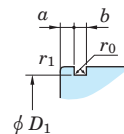

Snap ring groove details

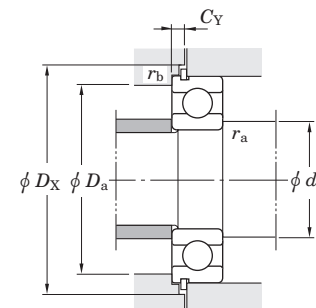

With locating snap ring and one shield

Boundary dimensions (mm)					Basic load ratings (kN)		Factor $f_0$	Limiting speeds ( $\text{min}^{-1}$ )		Bearing No.		$D_1$ max.	Dimensions of snap ring groove (mm)			Dimensions of locating snap ring (mm)		Mounting dimensions (mm)						(Refer.) Mass (kg)	(Refer.) Bearing No.
d	D	B	r min.	r1 min.	$C_r$	$C_{0r}$		Grease lub.	Oil lub.	With snap ring groove	With locating snap ring		a max.	b $\pm 0.15$	r0 max.	$D_2$ max.	f $\pm 0.05$	da min.	Da max.	DX min.	CY max.	ra max.	rb max.		
35	62	14	1	0.5	15.9	10.3	14.9	11 000	13 000	6007N	6007NR	59.61	2.08	2.05	0.6	67.7	1.65	40	58	68.5	3.48	1	0.5	0.155	6007N
	72	17	1.1	0.5	25.7	15.4	13.9	9 200	11 000	6207N	6207NR	68.81	3.28	2.05	0.6	78.6	1.65	41.5	65.5	80	4.67	1	0.5	0.288	6207N
	80	21	1.5	0.5	33.4	19.3	13.2	8 500	10 000	6307N	6307NR	76.81	3.28	2.05	0.6	86.6	1.65	43	72	88	4.67	1.5	0.5	0.457	6307N
40	68	15	1	0.5	16.7	11.5	15.2	10 000	12 000	6008N	6008NR	64.82	2.49	2.05	0.6	74.6	1.65	45	63	76	3.89	1	0.5	0.192	6008N
	80	18	1.1	0.5	29.1	17.8	14.0	8 300	10 000	6208N	6208NR	76.81	3.28	2.05	0.6	86.6	1.65	46.5	73.5	88	4.67	1	0.5	0.366	6208N
	90	23	1.5	0.5	40.7	24.0	13.2	7 700	9 200	6308N	6308NR	86.79	3.28	2.85	0.6	96.5	2.41	48	82	98	5.43	1.5	0.5	0.633	6308N
45	75	16	1	0.5	21.0	15.1	15.3	9 200	11 000	6009N	6009NR	71.83	2.49	2.05	0.6	81.6	1.65	50	70	83	3.89	1	0.5	0.245	6009N
	85	19	1.1	0.5	32.7	20.3	14.0	7 700	9 200	6209N	6209NR	81.81	3.28	2.05	0.6	91.6	1.65	51.5	78.5	93	4.67	1	0.5	0.407	6209N
	100	25	1.5	0.5	48.9	29.5	13.3	6 800	8 100	6309N	6309NR	96.8	3.28	2.85	0.6	106.5	2.41	53	92	108	5.43	1.5	0.5	0.833	6309N
50	80	16	1	0.5	21.8	16.6	15.6	8 400	9 900	6010N	6010NR	76.81	2.49	2.05	0.6	86.6	1.65	55	75	88	3.89	1	0.5	0.261	6010N
	90	20	1.1	0.5	35.1	23.3	14.4	7 100	8 500	6210N	6210NR	86.79	3.28	2.85	0.6	96.5	2.41	56.5	83.5	98	5.43	1	0.5	0.463	6210N
	110	27	2	0.5	62.0	38.3	13.2	6 100	7 300	6310N	6310NR	106.81	3.28	2.85	0.6	116.6	2.41	59	101	118	5.43	2	0.5	1.07	6310N
55	90	18	1.1	0.5	28.3	21.2	15.3	7 600	8 900	6011N	6011NR	86.79	2.87	2.85	0.6	96.5	2.41	61.5	83.5	98	5.03	1	0.5	0.385	6011N
	100	21	1.5	0.5	43.4	29.4	14.4	6 300	7 600	6211N	6211NR	96.8	3.28	2.85	0.6	106.5	2.41	63	92	108	5.43	1.5	0.5	0.607	6211N
	120	29	2	0.5	71.6	45.0	13.2	5 600	6 700	6311N	6311NR	115.21	4.06	3.25	0.6	129.7	2.77	64	111	131.5	6.58	2	0.5	1.37	6311N
60	95	18	1.1	0.5	29.4	23.2	15.6	7 100	8 400	6012N	6012NR	91.82	2.87	2.85	0.6	101.6	2.41	66.5	88.5	103	5.03	1	0.5	0.415	6012N
	110	22	1.5	0.5	52.4	36.2	14.4	5 700	6 900	6212N	6212NR	106.81	3.28	2.85	0.6	116.6	2.41	68	102	118	5.43	1.5	0.5	0.783	6212N
	130	31	2.1	0.5	81.9	52.2	13.2	5 200	6 200	6312N	6312NR	125.22	4.06	3.25	0.6	139.7	2.77	71	119	141.5	6.58	2	0.5	1.70	6312N
65	100	18	1.1	0.5	30.5	25.2	15.8	6 600	7 800	6013N	6013NR	96.8	2.87	2.85	0.6	106.5	2.41	71.5	93.5	108	5.03	1	0.5	0.435	6013N
	120	23	1.5	0.5	57.2	40.1	14.4	5 400	6 400	6213N	6213NR	115.21	4.06	3.25	0.6	129.7	2.77	73	112	131.5	6.58	1.5	0.5	0.990	6213N
	140	33	2.1	0.5	92.7	59.9	13.2	4 800	5 800	6313N	6313NR	135.23	4.9	3.25	0.6	149.7	2.77	76	129	152	7.37	2	0.5	2.08	6313N
70	110	20	1.1	0.5	38.1	30.9	15.6	6 100	7 200	6014N	6014NR	106.81	2.87	2.85	0.6	116.6	2.41	76.5	103.5	118	5.03	1	0.5	0.602	6014N
	125	24	1.5	0.5	62.2	44.1	14.5	5 100	6 100	6214N	6214NR	120.22	4.06	3.25	0.6	134.7	2.77	78	117	136.5	6.58	1.5	0.5	1.07	6214N
	150	35	2.1	0.5	104	68.2	13.2	4 500	5 400	6314N	6314NR	145.24	4.9	3.25	0.6	159.7	2.77	81	139	162	7.37	2	0.5	2.52	6314N
75	115	20	1.1	0.5	39.6	33.5	15.8	5 700	6 800	6015N	6015NR	111.81	2.87	2.85	0.6	121.6	2.41	81.5	108.5	123	5.03	1	0.5	0.638	6015N
	130	25	1.5	0.5	67.4	48.3	14.5	4 800	5 800	6215N	6215NR	125.22	4.06	3.25	0.6	139.7	2.77	83	122	141.5	6.58	1.5	0.5	1.18	6215N
	160	37	2.1	0.5	113	77.2	13.2	4 200	5 000	6315N	6315NR	155.22	4.9	3.25	0.6	169.7	2.77	86	149	172	7.37	2	0.5	3.02	6315N

[Remark] Standard cage types used for the above bearings are described earlier in this section.

Single-row deep groove ball bearings  
snap ring groove type  
locating snap ring type

$d$  80 ~ 130 mm

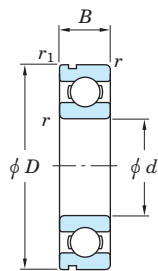

N  
With snap ring groove

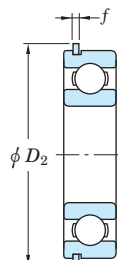

NR  
With locating snap ring

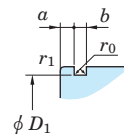

Snap ring groove details

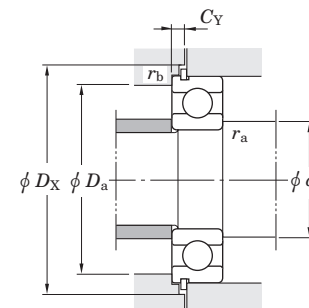

With locating snap ring and one shield

Boundary dimensions (mm)					Basic load ratings (kN)		Factor $f_0$	Limiting speeds ( $\text{min}^{-1}$ )		Bearing No.		$D_1$ max.	Dimensions of snap ring groove (mm)			Dimensions of locating snap ring (mm)		Mounting dimensions (mm)						(Refer.) Mass (kg)	(Refer.) Bearing No.
$d$	$D$	$B$	$r_{\text{min}}$	$r_{1\text{min}}$	$C_r$	$C_{0r}$		Grease lub.	Oil lub.	With snap ring groove	With locating snap ring		$a$ max.	$b$ $\pm 0.15$	$r_0$ max.	$D_2$ max.	$f$ $\pm 0.05$	$d_a$ min.	$D_a$ max.	$D_X$ min.	$C_Y$ max.	$r_a$ max.	$r_b$ max.		
80	125	22	1.1	0.5	47.6	39.8	15.6	5 300	6 300	6016N	6016NR	120.22	2.87	3.25	0.6	134.7	2.77	86.5	118.5	136.5	5.39	1	0.5	0.850	6016N
	140	26	2	0.5	72.7	53.0	14.6	4 500	5 400	6216N	6216NR	135.23	4.9	3.25	0.6	149.7	2.77	89	131	152	7.37	2	0.5	1.40	6216N
	170	39	2.1	0.5	123	86.7	13.3	3 900	4 700	6316N	6316NR	163.65	5.69	3.65	0.6	182.9	3.05	91	159	185	8.44	2	0.5	3.59	6316N
85	130	22	1.1	0.5	49.5	43.1	15.8	5 000	5 900	6017N	6017NR	125.22	2.87	3.25	0.6	139.7	2.77	91.5	123.5	141.5	5.39	1	0.5	0.890	6017N
	150	28	2	0.5	84.0	61.9	14.5	4 200	5 000	6217N	6217NR	145.24	4.9	3.25	0.6	159.7	2.77	94	141	162	7.37	2	0.5	1.79	6217N
	180	41	3	0.5	133	96.8	13.3	3 700	4 400	6317N	6317NR	173.66	5.69	3.65	0.6	192.9	3.05	98	167	195	8.44	2.5	0.5	4.23	6317N
90	140	24	1.5	0.5	58.2	49.7	15.6	4 700	5 600	6018N	6018NR	135.23	3.71	3.25	0.6	149.7	2.77	98	132	152	6.17	1.5	0.5	1.16	6018N
	160	30	2	0.5	96.1	71.5	14.5	3 900	4 700	6218N	6218NR	155.22	4.9	3.25	0.6	169.7	2.77	99	151	172	7.37	2	0.5	2.15	6218N
	190	43	3	0.5	143	107	13.3	3 500	4 200	6318N	6318NR	183.64	5.69	3.65	0.6	202.9	3.05	103	177	205	8.44	2.5	0.5	4.91	6318N
95	145	24	1.5	0.5	60.4	53.9	15.8	4 400	5 200	6019N	6019NR	140.23	3.71	3.25	0.6	154.7	2.77	103	137	157	6.17	1.5	0.5	1.21	6019N
	170	32	2.1	0.5	109	81.9	14.4	3 700	4 400	6219N	6219NR	163.65	5.69	3.65	0.6	182.9	3.05	106	159	185	8.44	2	0.5	2.62	6219N
	200	45	3	0.5	153	119	13.3	3 300	4 000	6319N	6319NR	193.65	5.69	3.65	0.6	212.9	3.05	108	187	215	8.44	2.5	0.5	5.67	6319N
100	150	24	1.5	0.5	60.2	54.2	15.9	4 300	5 100	6020N	6020NR	145.24	3.71	3.25	0.6	159.7	2.77	108	142	162	6.17	1.5	0.5	1.25	6020N
	180	34	2.1	0.5	122	93.1	14.4	3 500	4 200	6220N	6220NR	173.66	5.69	3.65	0.6	192.9	3.05	111	169	195	8.44	2	0.5	3.14	6220N
105	160	26	2	0.5	72.3	65.8	15.8	4 000	4 700	6021N	6021NR	155.22	3.71	3.25	0.6	169.7	2.77	114	151	172	6.17	2	0.5	1.59	6021N
	190	36	2.1	0.5	133	105	14.4	3 300	3 900	6221N	6221NR	183.64	5.69	3.65	0.6	202.9	3.05	116	179	205	8.44	2	0.5	3.70	6221N
110	170	28	2	0.5	82.0	73.0	15.6	3 800	4 500	6022N	6022NR	163.65	3.71	3.65	0.6	182.9	3.05	119	161	185	6.45	2	0.5	1.96	6022N
	200	38	2.1	0.5	144	117	14.4	3 100	3 700	6222N	6222NR	193.65	5.69	3.65	0.6	212.9	3.05	121	189	215	8.44	2	0.5	4.36	6222N
120	180	28	2	0.5	85.0	79.3	15.9	3 600	4 200	6024N	6024NR	173.66	3.71	3.65	0.6	192.9	3.05	129	171	195	6.45	2	0.5	2.07	6024N
130	200	33	2	0.5	106	101	15.8	3 200	3 800	6026N	6026NR	193.65	5.69	3.65	0.6	212.9	3.05	139	191	215	8.44	2	0.5	3.16	6026N

[Remark] Standard cage types used for the above bearings are described earlier in this section.

Extra-small ball bearings, miniature ball bearings

d 1 ~ (4) mm

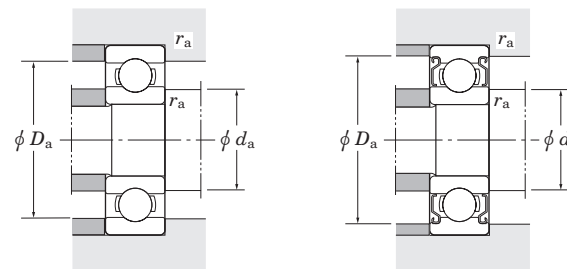
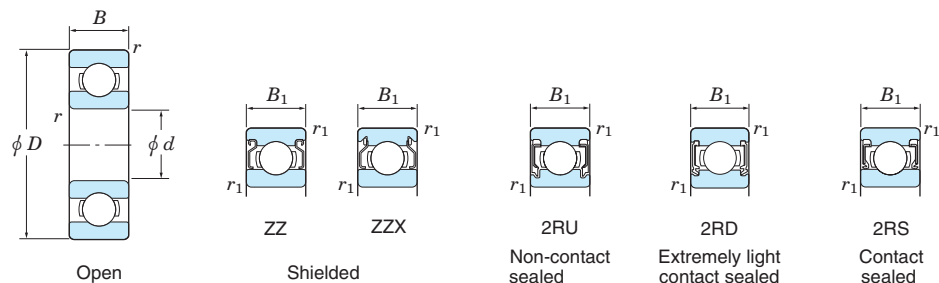

Boundary dimensions (mm)						Basic load ratings (kN)		Factor $f_0$	Limiting speeds ( $\text{min}^{-1}$ )				Bearing No.					Mounting dimensions (mm)			(Refer.) Mass (g)
d	D	B	$B_1$	$r_1^{(1)}$ min.	$r_1^{(1)}$ min.	$C_r$	$C_{0r}$		Grease lub.		Oil lub.		Open	Shielded	Non-contact sealed	Extremely light shielded	Contact sealed	$d_a$ min.	$D_a$ max.	$r_a$ max.	
<b>1</b>	3	1	—	0.07	—	0.10	0.03	11.6	130 000	—	—	150 000	<b>681</b>	—	—	—	—	1.6	2.4	0.05	0.03
	3	1.5	—	0.08	—	0.08	0.02	12.8	130 000	—	—	150 000	<b>ML1003</b>	—	—	—	—	1.6	2.4	0.07	0.05
	4	1.6	—	0.1	—	0.14	0.04	11.4	120 000	—	—	140 000	<b>691</b>	—	—	—	—	1.8	3.2	0.1	0.1
<b>1.2</b>	4	1.8	—	0.08	—	0.11	0.03	11.4	120 000	—	—	140 000	<b>ML1204</b>	—	—	—	—	1.8	3.4	0.07	0.1
<b>1.5</b>	4	1.2	2	0.1	0.1	0.11	0.03	13.2	120 000	—	—	140 000	<b>68/1.5</b>	<b>W68/1.5 ZZ</b>	—	—	—	2.3	3.2	0.1	0.1
	5	2	2.6	0.15	0.15	0.24	0.07	13.3	110 000	—	—	130 000	<b>69/1.5</b>	<b>W69/1.5 ZZX</b>	—	—	—	2.7	3.8	0.15	0.1
	6	2.5	3	0.1	0.1	0.33	0.10	11.4	86 000	—	—	100 000	<b>ML1506</b>	<b>WML1506 ZZX</b>	—	—	—	2.3	5.2	0.1	0.3
<b>2</b>	5	1.5	2.3	0.1	0.1	0.17	0.05	13.3	98 000	—	—	110 000	<b>682</b>	<b>W682 ZZX</b>	—	—	—	2.8	4.4	0.1	0.1
	5	2	2.5	0.1	0.08	0.17	0.05	13.3	98 000	—	—	110 000	<b>ML2005</b>	<b>WML2005 ZZ</b>	—	—	—	2.6	4.2	0.07	0.1
	6	2.3	3	0.15	0.1	0.33	0.10	11.4	86 000	—	—	100 000	<b>692</b>	<b>W692 ZZ</b>	—	—	—	3.2	4.8	0.1	0.2
	6	2.5	3	0.1	0.1	0.33	0.10	11.4	86 000	—	—	100 000	<b>ML2006</b>	<b>WML2006 ZZX</b>	—	—	—	2.8	5.2	0.1	0.3
	7	2.5	3	0.15	0.15	0.39	0.13	12.6	67 000	—	—	79 000	<b>ML2007</b>	<b>WML2007 ZZX</b>	—	—	—	3.2	5.8	0.15	0.4
	7	2.8	3.5	0.15	0.15	0.39	0.13	12.6	67 000	—	—	79 000	<b>602</b>	<b>W602 ZZX</b>	—	—	—	3.2	5.8	0.15	0.5
	<b>2.5</b>	6	1.8	2.6	0.1	0.1	0.19	0.06	14.3	75 000	—	—	89 000	<b>68/2.5</b>	<b>W68/2.5 ZZ</b>	—	—	—	3.3	5.2	0.1
7	2.5	3.5	0.15	0.15	0.31	0.11	13.7	66 000	—	—	79 000	<b>69/2.5</b>	<b>W69/2.5 ZZ</b>	—	—	—	3.7	5.8	0.15	0.4	
8	2.5	—	0.1	—	0.43	0.15	13.4	63 000	—	—	75 000	<b>ML2508/1B</b>	—	—	—	—	3.3	7.2	0.1	0.6	
8	2.8	4	0.15	0.1	0.55	0.17	11.5	64 000	—	—	76 000	<b>ML2508</b>	<b>WML2508 ZZX</b>	—	—	—	3.7	6.8	0.1	0.6	
<b>3</b>	6	2	2.5	0.08	0.05	0.19	0.06	14.3	75 000	—	—	89 000	<b>ML3006</b>	<b>WML3006 ZZ</b>	—	—	—	3.6	5.4	0.05	0.2
	7	2	3	(0.15)	(0.15)	0.31	0.11	13.7	66 000	—	—	79 000	<b>683</b>	<b>W683 ZZ</b>	—	—	—	4.2	5.8	0.1	0.3
	8	2.5	—	0.1	—	0.40	0.14	13.4	63 000	—	—	75 000	<b>ML3008</b>	—	—	—	—	3.8	7.2	0.1	0.5
	8	3	4	0.15	0.15	0.55	0.17	11.5	64 000	—	—	76 000	<b>693</b>	<b>W693 ZZ</b>	—	—	—	4.2	6.8	0.15	0.6
	9	3	5	0.15	0.15	0.43	0.16	14.0	60 000	—	—	72 000	<b>603</b>	<b>W603 ZZX</b>	—	—	—	4.2	7.8	0.15	0.9
	10	4	4	0.15	0.15	0.63	0.22	12.8	52 000	—	44 000	63 000	<b>623</b>	<b>623 ZZ</b>	—	—	<b>623 2RS</b>	4.2	8.8	0.15	1.6
	13	5	5	0.2	0.2	1.30	0.49	12.3	44 000	—	—	54 000	<b>633</b>	<b>633 ZZ</b>	—	—	—	4.6	11.4	0.2	3.0
<b>4</b>	7	2	2.5	0.08	0.05	0.26	0.11	15.1	64 000	—	—	76 000	<b>ML4007</b>	<b>WML4007 ZZ</b>	—	—	—	4.6	6.4	0.05	0.2
	8	2	3	0.1	0.08	0.40	0.14	14.6	61 000	—	—	73 000	<b>ML4008</b>	<b>WML4008 ZZ</b>	—	—	—	4.8	7.2	0.08	0.4
	9	2.5	4	(0.15)	(0.15)	0.64	0.23	12.8	59 000	—	—	70 000	<b>684</b>	<b>W684 ZZ</b>	—	—	—	5.2	7.8	0.1	0.6

[Note] 1) Numerical values in ( ) do not conform to JIS B 1521.

Extra-small ball bearings, miniature ball bearings

d (4) ~ (7) mm

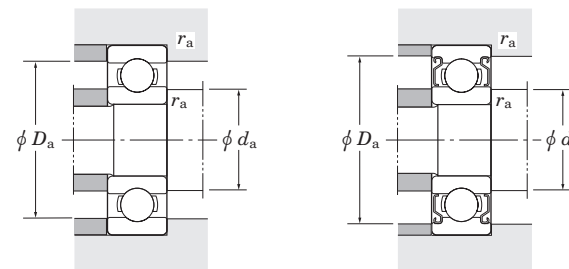
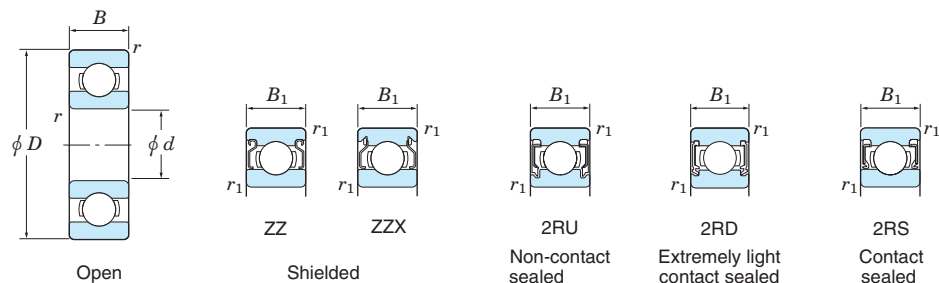

Boundary dimensions (mm)						Basic load ratings (kN)		Factor $f_0$	Limiting speeds (min <sup>-1</sup> )				Bearing No.					Mounting dimensions (mm)			(Refer.) Mass (g)
d	D	B	B <sub>1</sub>	r <sub>min.</sub>	r <sub>1 min.</sub>	C <sub>r</sub>	C <sub>0r</sub>		Grease lub.		Oil lub.		Open	Shielded	Non-contact sealed	Extremely light shielded	Contact sealed	d <sub>a min.</sub>	D <sub>a max.</sub>	r <sub>a max.</sub>	
									[Open ZZ, 2RU]	(2RD)	(2RS)	[Open Z]									
4	10	3	4	0.15	0.1	0.65	0.23	13.3	56 000	—	—	67 000	ML4010	WML4010 ZZ	—	—	—	5.2	8.8	0.1	1.0
	11	4	4	0.15	0.15	0.96	0.35	12.4	54 000	—	44 000	65 000	694	694 ZZ	694 2RU	—	694 2RS	5.2	9.8	0.15	1.8
	12	4	4	0.2	0.2	0.96	0.35	12.4	53 000	—	—	63 000	604	604 ZZ	—	—	—	5.6	10.4	0.2	2.1
	13	5	5	0.2	0.2	1.30	0.48	12.3	44 000	—	39 000	54 000	624	624 ZZ	624 2RU	—	624 2RS	5.6	11.4	0.2	2.9
	16	5	5	0.3	0.3	1.35	0.52	12.4	40 000	—	—	49 000	634	634 ZZ	—	—	—	6	14	0.3	5.3
5	8	2	2.5	0.08	0.05	0.22	0.09	15.7	59 000	—	—	70 000	ML5008	WML5008 ZZ	—	—	—	5.6	7.4	0.05	0.3
	9	2.5	3	0.1	0.08	0.43	0.17	15.3	56 000	—	—	67 000	ML5009	WML5009 ZZ	—	—	—	5.8	8.2	0.08	0.5
	10	3	4	0.1	0.1	0.43	0.17	14.8	55 000	—	—	65 000	ML5010	WML5010 ZZ	—	—	—	5.8	9	0.1	0.9
	11	3	5	0.15	0.15	0.71	0.28	12.8	53 000	—	—	63 000	685	W685 ZZ	—	—	—	6.2	9.8	0.15	1.0
	13	4	4	0.2	0.2	1.10	0.43	12.3	50 000	45 000	42 000	60 000	695	695 ZZ	695 2RU	695 2RD	695 2RS	6.6	11.4	0.2	2.2
	14	5	5	0.2	0.2	1.30	0.49	12.3	50 000	—	—	60 000	605	605 ZZ	—	—	—	6.6	12.4	0.2	3.5
	16	5	5	0.3	0.3	1.75	0.67	12.4	40 000	36 000	33 000	49 000	625	625 ZZ	625 2RU	—	625 2RS	7	14	0.3	5.0
	19	6	6	0.3	0.3	2.35	0.89	12.3	35 000	32 000	27 000	43 000	635	635 ZZ	635 2RU	—	635 2RS	7	17	0.3	8.5
6	10	2.5	3	0.1	0.08	0.50	0.22	15.7	53 000	—	—	63 000	ML6010	WML6010 ZZ	—	—	—	6.8	9.2	0.08	0.6
	12	3	4	0.15	0.1	0.71	0.29	14.5	49 000	—	37 000	59 000	ML6012	WML6012 ZZ	—	—	WML6012 2RS	7.2	10.8	0.1	1.3
	13	3.5	5	0.15	0.15	1.10	0.44	13.7	48 000	43 000	36 000	57 000	686	W686 ZZ	—	—	W686 2RS	7.2	11.8	0.15	1.8
	15	5	5	0.2	0.2	1.35	0.52	12.4	45 000	41 000	32 000	54 000	696	696 ZZ	696 2RU	696 2RD	696 2RS	7.6	13.4	0.2	3.9
	17	6	6	0.3	0.3	1.95	0.74	12.2	43 000	39 000	—	51 000	606	606 ZZ	606 2RU	606 2RD	—	8	15	0.3	5.8
	19	6	6	0.3	0.3	2.35	0.89	12.3	35 000	32 000	27 000	43 000	626	626 ZZ	626 2RU	626 2RD	626 2RS	8	17	0.3	8.1
	19	8	8	0.3	0.3	2.60	1.05	12.3	40 000	—	—	47 000	ML6019	ML6019 ZZ	—	—	—	7	18	0.3	9.0
	22	7	7	0.3	0.3	3.30	1.35	12.4	31 000	—	23 000	37 000	636	636 ZZ	—	—	636 2RS	8	20	0.3	13
7	11	2.5	3	0.1	0.08	0.43	0.23	16.1	49 000	—	—	59 000	ML7011	WML7011 ZZX	—	—	—	7.8	10.2	0.08	0.7
	13	3	4	0.15	0.15	0.54	0.28	14.9	47 000	—	—	55 000	ML7013	WML7013 ZZ	—	—	—	8.2	11.8	0.15	1.4
	14	3.5	5	0.15	0.15	1.15	0.51	14.2	45 000	—	—	54 000	687	W687 ZZ	—	—	—	8.2	12.8	0.15	2.0
	17	5	5	0.3	0.3	1.60	0.71	14.0	42 000	—	28 000	50 000	697	697 ZZ	—	—	697 2RS	9	15	0.3	5.3
	19	6	6	0.3	0.3	2.35	0.89	12.3	40 000	36 000	27 000	47 000	607	607 ZZ	607 2RU	607 2RD	607 2RS	9	17	0.3	7.6
	22	7	7	0.3	0.3	3.30	1.35	12.4	31 000	28 000	23 000	37 000	627	627 ZZ	627 2RU	627 2RD	627 2RS	9	20	0.3	13
	22	8	8	0.3	0.3	3.30	1.35	12.4	34 000	—	—	41 000	ML7022	ML7022 ZZ	—	—	—	9	20	0.3	14

Extra-small ball bearings, miniature ball bearings

d (7) ~ 9 mm

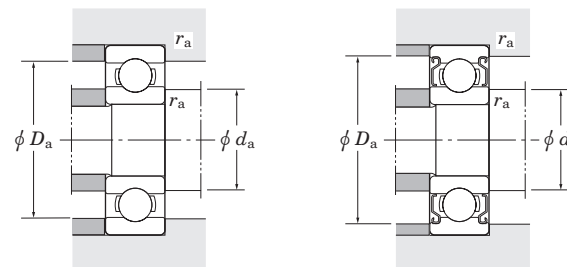
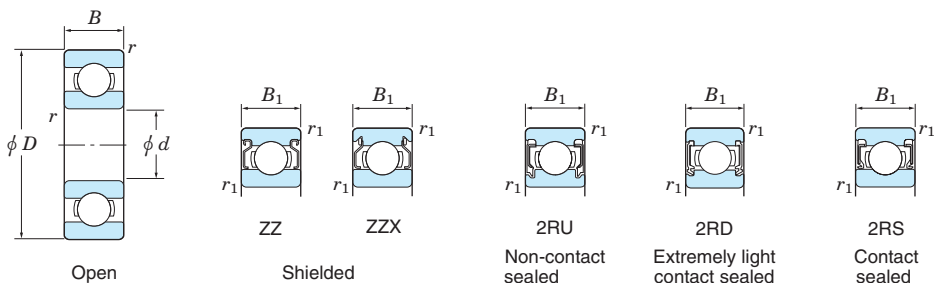

d	Boundary dimensions (mm)					Basic load ratings (kN)		Factor f <sub>0</sub>	Limiting speeds (min <sup>-1</sup> )				Bearing No.					Mounting dimensions (mm)			(Refer.) Mass (g)
	D	B	B <sub>1</sub>	r <sup>(1)</sup> <sub>min.</sub>	r <sup>(1)</sup> <sub>min.</sub>	C <sub>r</sub>	C <sub>0r</sub>		Grease lub.		Oil lub.		Open	Shielded	Non-contact sealed	Extremely light shielded	Contact sealed	d <sub>a</sub> min.	D <sub>a</sub> max.	r <sub>a</sub> max.	
7	26	9	9	0.3	0.3	4.55	1.95	12.3	[Open ZZ, 2RU]	(2RD)	(2RS)	[Open Z]	637	637 ZZ	—	—	—	9	24	0.3	24
8	12	2.5	3.5	0.1	0.08	0.54	0.27	16.4	47 000	—	—	55 000	ML8012	WML8012 ZZ	—	—	—	8.8	11.2	0.08	0.8
	14	3.5	4	0.15	0.15	0.81	0.39	15.3	44 000	—	—	52 000	ML8014	WML8014 ZZ	—	—	—	9.2	12.8	0.15	1.8
	16	4	5	0.2	0.2	1.25	0.59	14.0	42 000	38 000	28 000	50 000	688	W688 ZZ	W688 2RU	W688 2RD	W688 2RS	9.6	14.4	0.2	3.2
	19	6	6	0.3	0.3	2.25	0.91	12.9	39 000	35 000	27 000	46 000	698	698 ZZ	—	698 2RD	698 2RS	10	17	0.3	7.2
	22	7	7	0.3	0.3	3.30	1.35	12.4	34 000	31 000	23 000	41 000	608	608 ZZ	608 2RU	608 2RD	608 2RS	10	20	0.3	12
	24	8	8	0.3	0.3	3.35	1.40	12.8	28 000	—	22 000	35 000	628	628 ZZ	628 2RU	—	628 2RS	10	22	0.3	18
	28	9	9	0.3	0.3	4.55	1.95	12.3	26 000	23 000	—	32 000	638	638 ZZ	—	638 2RD	—	10	26	0.3	29
9	17	4	5	0.2	0.2	1.35	0.66	14.9	39 000	35 000	—	46 000	689	W689 ZZ	W689 2RU	W689 2RD	—	10.6	15.4	0.2	3.5
	20	6	6	0.3	0.3	2.45	1.05	13.3	35 000	32 000	25 000	42 000	699	699 ZZ	—	699 2RD	699 2RS	11	18	0.3	7.5
	24	7	7	0.3	0.3	3.35	1.40	12.8	33 000	30 000	22 000	40 000	609	609 ZZ	609 2RU	609 2RD	609 2RS	11	22	0.3	15
	26	8	8	(0.6)	(0.6)	4.55	1.95	12.4	27 000	24 000	19 000	33 000	629	629 ZZ	629 2RU	629 2RD	629 2RS	12.1	22	0.3	20
	30	10	10	0.6	0.6	4.65	2.10	12.3	24 000	—	—	29 000	639	639 ZZ	—	—	—	13	26	0.6	35

[Note] 1) Numerical values in ( ) do not conform to JIS B 1521.



Extra-small ball bearings, miniature ball bearings  
flanged type

$d$  1 ~ (4) mm

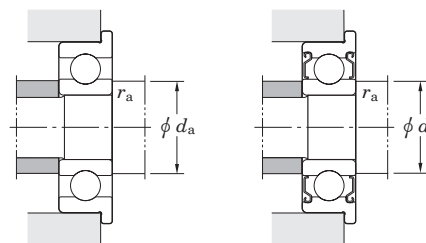
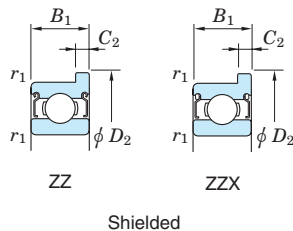
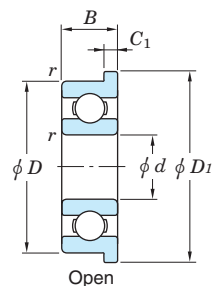

$d$	Boundary dimensions (mm)					Basic load ratings (kN)		Factor $f_0$	Limiting speeds ( $\text{min}^{-1}$ )		Bearing No.	Dimensions of flange (mm)				Mounting dimensions (mm)		(Refer.) Mass (g)		
	$D$	$B$	$B_1$	$r_1^{(1)}$ min.	$r_1^{(1)}$ min.	$C_r$	$C_{0r}$		Grease lub.	Oil lub.		$D_1$	$D_2$	$C_1$	$C_2$	$d_a$ min.	$r_a$ max.			
1	3	1	—	0.07	—	0.10	0.03	11.6	130 000	150 000	F681 F691	—	—	3.8	—	0.3	—	1.6	0.05	0.03
	4	1.6	—	0.1	—	0.14	0.04	11.4	120 000	140 000		—	—	5	—	0.5	—	1.8	0.1	0.1
1.5	4	1.2	2	0.1	0.1	0.11	0.03	13.2	120 000	140 000	F68/1.5 F69/1.5 MLF1506	—	WF68/1.5 ZZ WF69/1.5 ZZ WMLF1506 ZZ	5	5	0.4	0.6	2.3	0.1	0.1
	5	2	2.6	0.15	0.15	0.24	0.07	12.9	110 000	120 000		—	—	6.5	6.5	0.6	0.8	2.7	0.15	0.2
	6	2.5	3	0.1	0.1	0.33	0.10	11.4	86 000	100 000		—	—	7.5	7.5	0.6	0.8	2.3	0.1	0.4
2	5	1.5	2.3	0.1	0.1	0.17	0.05	13.3	99 000	120 000	F682 MLF2005 F692 MLF2006 MLF2007 F602	—	WF682 ZZ WMLF2005 ZZ WF692 ZZ WMLF2006 ZZ WMLF2007 ZZ WF602 ZZ	6.1	6.1	0.5	0.6	2.8	0.1	0.1
	5	2	2.5	0.1	0.08	0.17	0.05	12.9	99 000	120 000		—	—	6.2	6.2	0.6	0.6	2.8	0.07	0.2
	6	2.3	3	0.15	0.1	0.33	0.10	11.4	86 000	100 000		—	—	7.5	7.5	0.6	0.8	3.2	0.1	0.3
	6	2.5	3	0.1	0.1	0.33	0.10	11.4	86 000	100 000		—	—	7.2	7.2	0.6	0.6	2.8	0.1	0.4
	7	2.5	3	0.15	0.15	0.39	0.13	12.6	67 000	79 000		—	—	8.2	8.2	0.6	0.6	3.2	0.15	0.5
	7	2.8	3.5	0.15	0.15	0.39	0.13	12.6	67 000	79 000		—	—	8.5	8.5	0.7	0.9	3.2	0.15	0.6
2.5	6	1.8	2.6	0.1	0.1	0.21	0.07	14.3	69 000	82 000	F68/2.5 F69/2.5 MLF2508/1B MLF2508	—	WF68/2.5 ZZ WF69/2.5 ZZ — WMLF2508 ZZ	7.1	7.1	0.5	0.8	3.3	0.1	0.2
	7	2.5	3.5	0.15	0.15	0.39	0.13	12.7	66 000	79 000		—	—	8.5	8.5	0.7	0.9	3.7	0.15	0.5
	8	2.5	—	0.1	—	0.56	0.18	11.7	63 000	75 000		—	—	9.2	—	0.6	—	3.5	0.1	0.7
	8	2.8	4	0.15	0.1	0.56	0.18	11.5	63 000	75 000		—	—	9.5	9.5	0.7	0.9	3.7	0.1	0.7
3	6	2	2.5	0.08	0.05	0.21	0.07	14.3	69 000	82 000	MLF3006 F683 MLF3008 F693 F603 F623	—	WMLF3006 ZZ WF683 ZZ — WF693 ZZ WF603 ZZ F623 ZZ	7.2	7.2	0.6	0.6	3.6	0.05	0.2
	7	2	3	(0.15)	(0.15)	0.31	0.11	14.0	65 000	78 000		—	—	8.1	8.1	0.5	0.8	4.2	0.1	0.4
	8	2.5	—	0.1	—	0.40	0.14	13.4	61 000	72 000		—	—	9.2	—	0.6	—	4.0	0.1	0.6
	8	3	4	0.15	0.15	0.56	0.18	11.9	63 000	75 000		—	—	9.5	9.5	0.7	0.9	4.2	0.15	0.7
	9	3	5	0.15	0.15	0.57	0.19	12.4	60 000	72 000		—	—	10.5	10.5	0.7	1	4.2	0.15	1.0
	10	4	4	0.15	0.15	0.63	0.22	12.4	61 000	72 000		—	—	11.5	11.5	1	1	4.2	0.15	1.8
4	7	2	2.5	0.08	0.05	0.25	0.11	15.1	63 000	75 000	MLF4007 MLF4008 F684 MLF4010 F694 F604	—	WMLF4007 ZZ WMLF4008 ZZ WF684 ZZ WMLF4010 ZZ F694 ZZ F604 ZZ	8.2	8.2	0.6	0.6	4.6	0.05	0.3
	8	2	3	0.1	0.08	0.40	0.14	13.9	61 000	72 000		—	—	9.2	9.2	0.6	0.6	4.8	0.08	0.5
	9	2.5	4	(0.15)	(0.15)	0.64	0.23	12.8	59 000	70 000		—	—	10.3	10.3	0.6	1	5.2	0.1	0.7
	10	3	4	0.15	0.1	0.71	0.27	13.5	56 000	66 000		—	—	11.2	11.6	0.6	0.8	5.2	0.1	1.1
	11	4	4	0.15	0.15	0.96	0.35	12.4	54 000	65 000		—	—	12.5	12.5	1	1	5.2	0.15	2.0
	12	4	4	0.2	0.2	0.96	0.35	12.4	54 000	65 000		—	—	13.5	13.5	1	1	5.6	0.2	2.3

[Note] 1) Numerical values in ( ) do not conform to JIS B 1521.

Extra-small ball bearings, miniature ball bearings  
flanged type

$d$  (4) ~ 8 mm

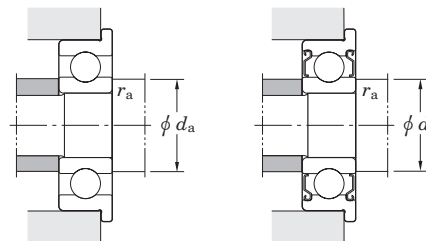
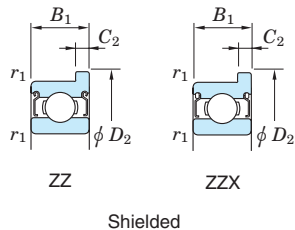
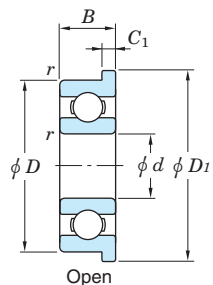

Boundary dimensions (mm)					Basic load ratings (kN)		Factor $f_0$	Limiting speeds ( $\text{min}^{-1}$ )		Bearing No.	Dimensions of flange (mm)				Mounting dimensions (mm)		(Refer.) Mass (g)		
$d$	$D$	$B$	$B_1$	$r_{\text{min}}$	$r_1$ min.	$C_r$		$C_{0r}$	Grease lub.		Oil lub.	Open	Shielded	$D_1$	$D_2$	$C_1$		$C_2$	$d_a$ min.
4	13	5	5	0.2	0.2	1.30	0.48	12.2	50 000	60 000	<b>F624</b>	<b>F624 ZZ</b>	15	15	1	1	5.6	0.2	3.3
	16	5	5	0.3	0.3	1.35	0.52	13.0	47 000	55 000	<b>F634</b>	<b>F634 ZZ</b>	18	18	1	1	6	0.3	5.7
5	8	2	2.5	0.08	0.05	0.22	0.09	15.8	59 000	70 000	<b>MLF5008</b>	<b>WMLF5008 ZZ</b>	9.2	9.2	0.6	0.6	5.6	0.05	0.4
	9	2.5	3	0.1	0.08	0.43	0.17	14.6	57 000	67 000	<b>MLF5009</b>	<b>WMLF5009 ZZ</b>	10.2	10.2	0.6	0.6	5.8	0.08	0.6
	10	3	4	0.1	0.1	0.43	0.17	14.8	57 000	67 000	<b>MLF5010</b>	<b>WMLF5010 ZZ</b>	11.2	11.6	0.6	0.8	5.8	0.1	1.0
	11	3	5	0.15	0.15	0.71	0.28	14.0	53 000	63 000	<b>F685</b>	<b>WF685 ZZ</b>	12.5	12.5	0.8	1	6.2	0.15	1.1
	13	4	4	0.2	0.2	1.10	0.43	13.4	49 000	59 000	<b>F695</b>	<b>F695 ZZ</b>	15	15	1	1	6.6	0.2	2.5
	14	5	5	0.2	0.2	1.35	0.51	12.3	48 000	57 000	<b>F605</b>	<b>F605 ZZ</b>	16	16	1	1	6.6	0.2	3.9
	16	5	5	0.3	0.3	1.75	0.67	12.4	45 000	54 000	<b>F625</b>	<b>F625 ZZ</b>	18	18	1	1	7	0.3	5.4
	19	6	6	0.3	0.3	2.35	0.89	12.3	40 000	47 000	<b>F635</b>	<b>F635 ZZ</b>	22	22	1.5	1.5	7	0.3	9.7
6	10	2.5	3	0.1	0.08	0.50	0.22	15.2	53 000	63 000	<b>MLF6010</b>	<b>WMLF6010 ZZ</b>	11.2	11.2	0.6	0.6	6.8	0.08	0.7
	12	3	4	0.15	0.1	0.71	0.29	14.5	49 000	59 000	<b>MLF6012</b>	<b>WMLF6012 ZZ</b>	13.2	13.6	0.6	0.8	7.2	0.1	1.4
	13	3.5	5	0.15	0.15	1.10	0.44	13.7	48 000	57 000	<b>F686</b>	<b>WF686 ZZ</b>	15	15	1	1.1	7.2	0.15	2.1
	15	5	5	0.2	0.2	1.35	0.52	13.0	47 000	55 000	<b>F696</b>	<b>F696 ZZ</b>	17	17	1.2	1.2	7.6	0.2	4.3
	17	6	6	0.3	0.3	2.25	0.84	11.4	43 000	52 000	<b>F606</b>	<b>F606 ZZ</b>	19	19	1.2	1.2	8	0.3	6.3
	19	6	6	0.3	0.3	2.35	0.89	12.3	40 000	47 000	<b>F626</b>	<b>F626 ZZ</b>	22	22	1.5	1.5	8	0.3	9.2
	22	7	7	0.3	0.3	3.30	1.35	12.4	34 000	41 000	<b>F636</b>	<b>F636 ZZ</b>	25	25	1.5	1.5	8	0.3	14
7	11	2.5	3	0.1	0.08	0.46	0.20	15.6	49 000	59 000	<b>MLF7011</b>	<b>WMLF7011 ZZ</b>	12.2	12.2	0.6	0.6	7.8	0.08	0.8
	13	3	4	0.15	0.15	0.54	0.28	16.0	46 000	55 000	<b>MLF7013</b>	<b>WMLF7013 ZZ</b>	14.2	14.6	0.6	0.8	8.2	0.15	1.5
	14	3.5	5	0.15	0.15	1.15	0.51	14.2	45 000	54 000	<b>F687</b>	<b>WF687 ZZ</b>	16	16	1	1.1	8.2	0.15	2.4
	17	5	5	0.3	0.3	1.60	0.71	14.0	42 000	50 000	<b>F697</b>	<b>F697 ZZ</b>	19	19	1.2	1.2	9	0.3	5.8
	19	6	6	0.3	0.3	2.35	0.89	12.1	40 000	47 000	<b>F607</b>	<b>F607 ZZ</b>	22	22	1.5	1.5	9	0.3	8.7
	22	7	7	0.3	0.3	3.30	1.35	12.4	34 000	41 000	<b>F627</b>	<b>F627 ZZ</b>	25	25	1.5	1.5	9	0.3	14
8	12	2.5	3.5	0.1	0.08	0.54	0.27	15.9	47 000	55 000	<b>MLF8012</b>	<b>WMLF8012 ZZ</b>	13.2	13.6	0.6	0.8	8.8	0.08	0.9
	14	3.5	4	0.15	0.15	0.87	0.42	15.3	44 000	52 000	<b>MLF8014</b>	<b>WMLF8014 ZZ</b>	15.6	15.6	0.8	0.8	9.2	0.15	2.0
	16	4	5	0.2	0.2	1.25	0.59	14.8	42 000	50 000	<b>F688</b>	<b>WF688 ZZ</b>	18	18	1	1.1	9.6	0.2	3.6
	19	6	6	0.3	0.3	2.25	0.91	12.9	39 000	46 000	<b>F698</b>	<b>F698 ZZ</b>	22	22	1.5	1.5	10	0.3	8.3
	22	7	7	0.3	0.3	3.30	1.35	12.4	34 000	41 000	<b>F608</b>	<b>F608 ZZ</b>	25	25	1.5	1.5	10	0.3	13

Extra-small ball bearings, miniature ball bearings  
flanged type

$d$  9 mm

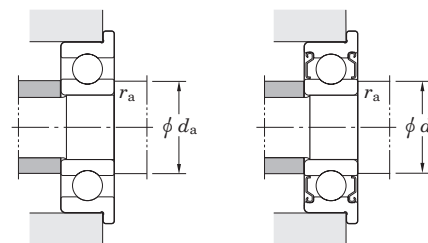
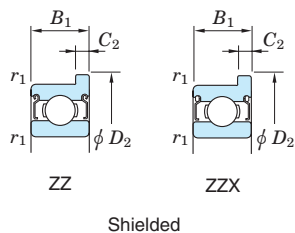
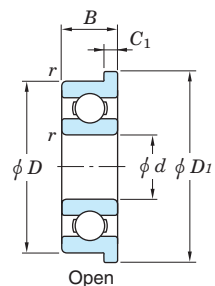

$d$	Boundary dimensions (mm)					Basic load ratings (kN)		Factor $f_0$	Limiting speeds ( $\text{min}^{-1}$ )		Bearing No.		Dimensions of flange (mm)				Mounting dimensions (mm)		(Refer.) Mass (g)
	$D$	$B$	$B_1$	$r_{\text{min.}}$	$r_{1\text{min.}}$	$C_r$	$C_{0r}$		Grease lub.	Oil lub.	Open	Shielded	$D_1$	$D_2$	$C_1$	$C_2$	$d_a$ min.	$r_a$ max.	
9	17	4	5	0.2	0.2	1.35	0.66	15.1	39 000	46 000	<b>F689</b>	<b>WF689 ZZ</b>	19	19	1	1.1	10.6	0.2	3.9
	20	6	6	0.3	0.3	2.45	1.05	13.3	37 000	44 000	<b>F699</b>	<b>F699 ZZ</b>	23	23	1.5	1.5	11	0.3	8.7
	24	7	7	0.3	0.3	3.35	1.45	12.8	32 000	38 000	<b>F609</b>	<b>F609 ZZ</b>	27	27	1.5	1.5	11	0.3	16

Double-row deep groove ball bearings

$d$  10 ~ (60) mm

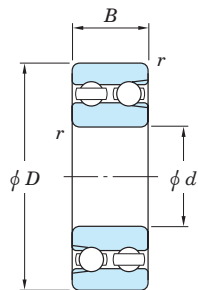

Boundary dimensions (mm)				Basic load ratings (kN)		Factor $f_0$	Limiting speeds ( $\text{min}^{-1}$ )		Bearing No.	Mounting dimensions (mm)			(Refer.) Mass (kg)
$d$	$D$	$B$	$r_{\text{min.}}$	$C_r$	$C_{0r}$		Grease lub.	Oil lub.		$d_a$ min.	$D_a$ max.	$r_a$ max.	
<b>10</b>	30	14	0.6	7.70	5.90	13.0	15 000	20 000	<b>4200</b>	14	26	0.6	0.057
<b>12</b>	32	14	0.6	7.75	6.15	13.6	14 000	18 000	<b>4201</b>	16	28	0.6	0.062
<b>15</b>	35	14	0.6	9.75	9.00	14.2	12 000	16 000	<b>4202</b>	19	31	0.6	0.071
	42	17	1	13.1	11.7	13.7	11 000	14 000	<b>4302</b>	20	37	1	0.123
<b>17</b>	40	16	0.6	11.7	10.4	14.1	11 000	14 000	<b>4203</b>	21	36	0.6	0.106
	47	19	1	16.5	15.0	13.7	9 400	13 000	<b>4303</b>	22	42	1	0.171
<b>20</b>	47	18	1	16.4	16.0	14.2	9 000	12 000	<b>4204</b>	25	42	1	0.165
	52	21	1.1	19.5	17.0	13.5	8 300	11 000	<b>4304</b>	26.5	45.5	1	0.227
<b>25</b>	52	18	1	16.3	16.9	15.0	7 500	9 900	<b>4205</b>	30	47	1	0.189
	62	24	1.1	26.3	25.7	14.1	6 700	9 000	<b>4305</b>	31.5	55.5	1	0.365
<b>30</b>	62	20	1	22.0	24.7	15.1	6 400	8 500	<b>4206</b>	35	57	1	0.298
	72	27	1.1	35.5	35.9	14.0	5 700	7 600	<b>4306</b>	36.5	65.5	1	0.542
<b>35</b>	72	23	1.1	26.4	30.7	15.2	5 600	7 400	<b>4207</b>	41.5	65.5	1	0.460
	80	31	1.5	40.6	41.8	14.1	5 200	7 000	<b>4307</b>	43	72	1.5	0.752
<b>40</b>	80	23	1.1	33.7	42.4	15.5	4 700	6 300	<b>4208</b>	46.5	73.5	1	0.558
	90	33	1.5	46.0	48.8	14.7	4 600	6 100	<b>4308</b>	48	82	1.5	1.01
<b>45</b>	85	23	1.1	31.9	43.9	15.8	4 600	6 100	<b>4209</b>	51.5	78.5	1	0.605
	100	36	1.5	57.6	62.4	14.3	4 100	5 500	<b>4309</b>	53	92	1.5	1.35
<b>50</b>	90	23	1.1	31.4	44.6	16.1	4 200	5 600	<b>4210</b>	56.5	83.5	1	0.651
	110	40	2	70.4	77.7	14.2	3 700	5 000	<b>4310</b>	59	101	2	1.80
<b>55</b>	100	25	1.5	37.2	54.1	16.1	3 800	5 000	<b>4211</b>	63	92	1.5	0.882
	120	43	2	84.2	94.4	14.2	3 400	4 600	<b>4311</b>	64	111	2	2.29
<b>60</b>	110	28	1.5	47.9	67.6	15.9	3 500	4 700	<b>4212</b>	68	102	1.5	1.20

$d$  (60) ~ 75 mm

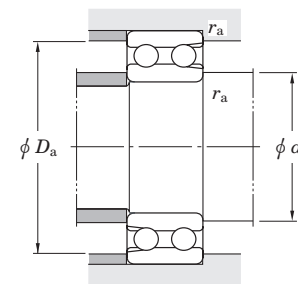

Boundary dimensions (mm)				Basic load ratings (kN)		Factor $f_0$	Limiting speeds ( $\text{min}^{-1}$ )		Bearing No.	Mounting dimensions (mm)			(Refer.) Mass (kg)
$d$	$D$	$B$	$r_{\text{min.}}$	$C_r$	$C_{0r}$		Grease lub.	Oil lub.		$d_a$ min.	$D_a$ max.	$r_a$ max.	
<b>60</b>	130	46	2.1	99.2	113	14.1	3 100	4 200	<b>4312</b>	71	119	2	2.87
<b>65</b>	120	31	1.5	54.7	78.5	15.9	3 200	4 300	<b>4213</b>	73	112	1.5	1.59
	140	48	2.1	107	124	14.3	2 900	3 900	<b>4313</b>	76	129	2	3.46
<b>70</b>	125	31	1.5	62.1	89.8	15.8	3 100	4 100	<b>4214</b>	78	117	1.5	1.68
	150	51	2.1	115	136	14.4	2 700	3 600	<b>4314</b>	81	139	2	4.21
<b>75</b>	130	31	1.5	61.6	90.7	16.0	2 900	3 900	<b>4215</b>	83	122	1.5	1.77
	160	55	2.1	132	158	14.4	2 500	3 400	<b>4315</b>	86	149	2	5.15

## Angular contact ball bearings

Angular contact ball bearings are suitable for applications which require high accuracy and good high-speed performance. This type of bearing is designed to carry a combined load.

- Single-row angular contact ball bearings and matched pair angular contact ball bearings

- The standard contact angles are 15°, 30° and 40°. They are identified, respectively, by the supplementary codes "C", "A" (omitted) and "B". Bearings with a smaller contact angle are more suitable for applications involving high-speed rotation. Those with a larger contact angle feature superior axial load resistance.

Contact angle

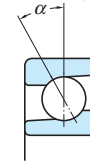

- Angular contact ball bearings are often preloaded to enhance their rigidity and rotating performance.

(refer to p. A 106.)

For high-precision matched pair angular contact ball bearings of class 5 or higher, which are used in machine tools and other precision equipment, the standard preload is specified in three levels: slight (S), light (L), medium (M) and heavy (H). (refer to Table 11-2 on p. A 108.)

- When this type of bearing is loaded radially, an axial component of force is produced. In this case, two bearings are used together facing one another, or two or more bearings are matched and used. (refer to p. A 34.)
- Tables 1 and 2 list the different types of single-row and matched pair/stack angular contact ball bearings and describe their characteristics.

- Double-row angular contact ball bearings

Consist of two single-row angular contact ball bearings matched back-to-back, with inner and outer rings integrated.

Table 3 shows major types and their characteristics.

- Four-point contact ball bearings

- Have a contact angle of 35° and an inner ring divided into two annular pieces. They are suitable for applications that involve either axial loading or combined loading, where the axial load makes up the major part of the load.
- Able to support both axial load and a certain degree of radial load. Each rolling element is in contact with each of the inner and outer rings at a single point, and both contact points lie on the contact angle line. The line runs to either the right or left depending on the direction of the axial load.

### Single-row angular contact ball bearings



Bore diameter 10 – 380 mm

### Matched pair angular contact ball bearings

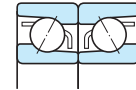

Bore diameter 10 – 380 mm

### Double-row angular contact ball bearings

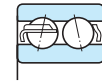

Bore diameter 10 – 110 mm

### Four-point contact ball bearings



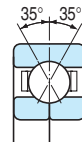

Bore diameter 20 – 110 mm



- Consult with JTEKT when using the four-point contact ball bearing because application conditions such as load magnitude should be examined carefully.

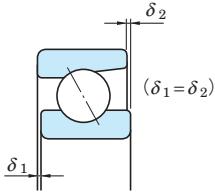

**Table 1 Single-row angular contact ball bearings**

<p>Standard type</p>  <p>(with pressed cage)</p>  <p>(with machined cage)</p>	<ul style="list-style-type: none"> <li>Single-row angular contact ball bearings accommodate radial load and axial load in one direction.</li> <li>Bearings with a machined cage are suitable for high-speed applications.</li> </ul>
<p>HAR type for high-speed applications</p> 	<ul style="list-style-type: none"> <li>Compared with the standard type, this type has more balls that are smaller in diameter and are often used in machine tool spindles. For details, see the separately issued catalog for high ability bearings, CAT No.B2006 for High Ability Ball Bearing Series Angular Contact Ball Bearings for Machining Tools.</li> </ul>

**Reference G-type bearing**

"G-type" bearings have a stand-out between the inner ring and outer ring on both sides that are equal in size. This arrangement is called "flush ground processing." These bearings can be matched in a variety of ways.



$\delta_1 = \delta_2$

**Table 2 Matched pair and stack angular contact ball bearings**

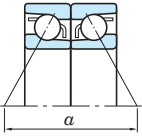
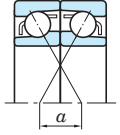
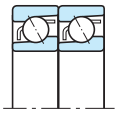
<p>Back-to-back arrangement (DB)</p> 	<ul style="list-style-type: none"> <li>Carries radial load and axial load in both directions.</li> <li>Suitable for applications involving moment loading because the distance between the load centers (<math>a</math>) is long.</li> <li>As for the preloaded type, the clearance is pre-adjusted so that bearings will be preloaded the proper amount when the inner ring is fixed with a nut.</li> </ul>
<p>Face-to-face arrangement (DF)</p> 	<ul style="list-style-type: none"> <li>Carries radial load and axial load in both directions.</li> <li>Has a smaller moment load accommodating capacity than the back-to-back arrangement, because the distance between the load centers (<math>a</math>) is shorter.</li> <li>As for the preloaded type, the clearance is pre-adjusted so that bearings will be preloaded the proper amount when the outer rings are pressed together.</li> </ul>
<p>Tandem arrangement (DT)</p> 	<ul style="list-style-type: none"> <li>Carries radial load and axial load in one direction.</li> <li>Suitable for applications which involve a high degree of axial loading.</li> </ul>

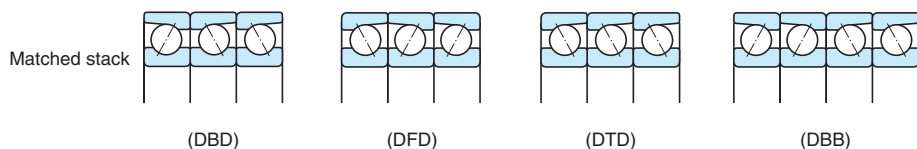

**Table 3 Double-row angular contact ball bearings**

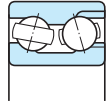
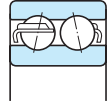
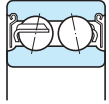
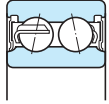
 <p>(with filling slot) 32, 33</p>  <p>(without filling slot) 52, 53</p>	<ul style="list-style-type: none"> <li>Accommodates radial load and axial load in both directions. Also able to accommodate moment load. When installing bearings with filling slot (32 and 33 series), the raceway side without filling slot must accommodate main load.</li> <li>The 32 and 33 series are provided with a filling slot, while the 52 and 53 series are not.</li> <li>32 and 33 series : contact angle 32° 52 and 53 series : contact angle 24°</li> <li>Inferior to single-row and matched pair angular contact ball bearings in terms of high-speed and high accuracy performance.</li> <li>Shielded or sealed 52 and 53 series bearings are also available.</li> </ul>
 <p>Shielded 52...ZZ, 53...ZZ</p>  <p>Sealed 52...2RS, 53...2RS</p>	

Boundary dimensions	The dimensions of standard series are as specified in JIS B 1512.																																							
Tolerances	<p>As specified in JIS B 1514-1. (refer to Table 7-3 on pp. A 54 – A 57.)</p> <p>JTEKT has established "special tolerances" for bore diameter and outside diameter, as listed in the table to the right, to make it easy to produce high-precision matched stack bearings. Bearings which are produced based on these tolerances are identified by the supplementary code "K5."</p> <table border="1" data-bbox="1749 794 2150 1037"> <thead> <tr> <th colspan="2" rowspan="2">Nominal bore diameter <math>d</math> (mm)</th> <th colspan="4">Special tolerances (K5) Unit : <math>\mu\text{m}</math></th> </tr> <tr> <th colspan="2">Single plane mean bore diameter (<math>\Delta d_{mp}</math>) or single plane mean outside diameter deviation (<math>\Delta D_{mp}</math>)</th> <th colspan="2"></th> </tr> <tr> <th>over</th> <th>up to</th> <th>class 5 upper</th> <th>class 5 lower</th> <th>class 4 upper</th> <th>class 4 lower</th> </tr> </thead> <tbody> <tr> <td>–</td> <td>50</td> <td>–1</td> <td>–4</td> <td>–1</td> <td>–3</td> </tr> <tr> <td>50</td> <td>80</td> <td>–1</td> <td>–5</td> <td>–1</td> <td>–4</td> </tr> <tr> <td>80</td> <td>120</td> <td>–1</td> <td>–5</td> <td>–1</td> <td>–4</td> </tr> </tbody> </table>						Nominal bore diameter $d$ (mm)		Special tolerances (K5) Unit : $\mu\text{m}$				Single plane mean bore diameter ( $\Delta d_{mp}$ ) or single plane mean outside diameter deviation ( $\Delta D_{mp}$ )				over	up to	class 5 upper	class 5 lower	class 4 upper	class 4 lower	–	50	–1	–4	–1	–3	50	80	–1	–5	–1	–4	80	120	–1	–5	–1	–4
Nominal bore diameter $d$ (mm)		Special tolerances (K5) Unit : $\mu\text{m}$																																						
		Single plane mean bore diameter ( $\Delta d_{mp}$ ) or single plane mean outside diameter deviation ( $\Delta D_{mp}$ )																																						
over	up to	class 5 upper	class 5 lower	class 4 upper	class 4 lower																																			
–	50	–1	–4	–1	–3																																			
50	80	–1	–5	–1	–4																																			
80	120	–1	–5	–1	–4																																			
Internal clearance	<ul style="list-style-type: none"> <li>Matched pair bearing axial internal clearance.....(refer to Table 10-4 on p. A 97.)</li> <li>Double-row bearing radial internal clearance.....(refer to Table 10-5 on p. A 98.)</li> </ul>																																							
Recommended fits	<ul style="list-style-type: none"> <li>Classes 0 and 6 bearings.....(refer to Table 9-4 on pp. A 85, 86.)</li> <li>Classes 5 and 4 bearings.....as listed in the table below.</li> </ul> <table border="1" data-bbox="1749 1185 2150 1401"> <thead> <tr> <th colspan="2" rowspan="2">Fit</th> <th>class 5</th> <th>class 4</th> </tr> <tr> <th colspan="2">Tolerance class</th> </tr> </thead> <tbody> <tr> <td rowspan="2">With shaft</td> <td>Inner ring rotation</td> <td>js 5</td> <td>js 4</td> </tr> <tr> <td>Outer ring rotation</td> <td>h 5</td> <td>h 4</td> </tr> <tr> <td rowspan="3">With housing</td> <td>Fixed side</td> <td>JS 6</td> <td>JS 5</td> </tr> <tr> <td>Free side</td> <td>H 6</td> <td>H 5</td> </tr> <tr> <td>Outer ring rotation</td> <td>M 5</td> <td>M 4</td> </tr> </tbody> </table> <p>Refer to Table 11-3 on page A 109 for the recommended fits of high-precision matched pair bearings (class 5 and class 4), which are used with light preload (L) or middle preload (M).</p>						Fit		class 5	class 4	Tolerance class		With shaft	Inner ring rotation	js 5	js 4	Outer ring rotation	h 5	h 4	With housing	Fixed side	JS 6	JS 5	Free side	H 6	H 5	Outer ring rotation	M 5	M 4											
Fit		class 5	class 4																																					
		Tolerance class																																						
With shaft	Inner ring rotation	js 5	js 4																																					
	Outer ring rotation	h 5	h 4																																					
With housing	Fixed side	JS 6	JS 5																																					
	Free side	H 6	H 5																																					
	Outer ring rotation	M 5	M 4																																					

Standard cages	<ul style="list-style-type: none"> <li>Pressed steel cage (supplementary code : //)</li> <li>Copper alloy machined cage (supplementary code : FY)</li> </ul> <p>[Note] Machine tools are generally equipped with bearings that have a phenolic resin machined cage (FT). Bearings with a polyamide molded cage can also be used depending on the applications. Four-point contact ball bearings usually use a copper alloy machined cage.</p>	<b>Application of standard cages</b>		
		<b>Bearing series</b>	<b>Pressed cage</b>	<b>Machined cage</b>
		79C 79CPA	— —	7900C – 7932C 7900CPA – 7932CPA
		70 70B 70C 70CPA	— — — —	7000 – 7040 7000B – 7040B 7000C – 7040C 7000CPA – 7034CPA
		72 72B 72C 72CPA	7200 – 7220 7200B – 7220B 7200C – 7220C —	7200 – 7240 7200B – 7240B 7200C – 7240C 7200CPA – 7230CPA
		73 73B 73C	7300 – 7320 7303B – 7320B 7303C – 7320C	7300 – 7340 7303B – 7340B 7303C – 7334C
		74 74B	7405 – 7409 7405B – 7409B	7404 – 7418 7404B – 7418B
		HAR9C HAR0C	— —	HAR910C – HAR934C HAR006C – HAR034C
		32 33	3200 – 3215 3302 – 3313	3216 – 3222 3314 – 3322
		52 53	5203 – 5214 5304 – 5315	— —

Allowable misalignment Single-row.....0.000 6 rad (2') : Matched pair, double-row.....misalignment not allowed

Equivalent radial load [Single-row and matched pair angular contact ball bearings]	Dynamic equivalent radial load $P_r = XF_r + YF_a$	Contact angle	$i f_0 F_a^*$	$e$	Single-row and tandem arrangement				Back-to-back and face-to-face arrangement			
					$F_a/F_r \leq e$		$F_a/F_r > e$		$F_a/F_r \leq e$		$F_a/F_r > e$	
					X	Y	X	Y	X	Y	X	Y
[Note] When two single-row angular contact ball bearings are used facing one another, an axial component of force is produced under radial load. In this case, refer to page A 34 for calculation of the dynamic equivalent radial load.	$P_r = XF_r + YF_a$	15°	0.178	0.38			1.47		1.65		2.39	
			0.357	0.40			1.40		1.57		2.28	
			0.714	0.43			1.30		1.46		2.11	
			1.07	0.46	1	0	0.44	1.23	1.38	0.72	2.00	
			1.43	0.47			1.19	1.19	1.34		1.93	
			2.14	0.50			1.12	1.12	1.26		1.82	
			3.57	0.55			1.02	1.14	1.14		1.66	
			5.35	0.56			1.00	1.12	1.12		1.63	
			7.14	0.56			1.00	1.12	1.12		1.63	
			30°	—	0.80	1	0	0.39	0.76	1	0.78	0.63
40°	—	1.14	1	0	0.35	0.57	1	0.55	0.57	0.93		

\* For  $i$ , use 2 for DB&DF and 1 for single&DT. Factor  $f_0$  is shown in the bearing dimension table.

Static equivalent radial load

$$P_{0r} = X_0 F_r + Y_0 F_a$$

In reference to single-row and tandem arrangement bearings,

when  $P_{0r} < F_r$ ,  
 $P_{0r} = F_r$

Contact angle	Single-row and tandem arrangement		Back-to-back and face-to-face arrangement	
	$X_0$	$Y_0$	$X_0$	$Y_0$
15°	0.5	0.46	1	0.92
30°	0.5	0.33	1	0.66
40°	0.5	0.26	1	0.52

Equivalent radial load [Double-row angular contact ball bearings]	Dynamic equivalent radial load $P_r = XF_r + YF_a$						
	Contact angle	$e$	$F_a/F_r \leq e$		$F_a/F_r > e$		(reference)
			X	Y	X	Y	
24°	0.66	1	0.95	0.68	1.45	52, 53 series	
32°	0.86	1	0.73	0.62	1.17	32, 33 series	
Static equivalent radial load $P_{0r} = X_0 F_r + Y_0 F_a$							
Contact angle	$X_0$	$Y_0$	(reference)				
			24°	1	0.78	52, 53 series	
			32°	1	0.63	32, 33 series	

[Note] In angular contact ball bearings, slippage occurs between the balls and raceways under too small a load, causing smearing to develop. Matched pair bearings may develop smearing when the ratio of the axial load to the radial load exceeds the value of  $e$  ( $F_a / F_r > e$ ), as listed in the specification table. Consult with JTEKT when these bearings are used under the above conditions.

[Reference] Relationship between axial load and axial displacement

Diagrams (1) to (9) illustrate the relationship between axial load and axial displacement.

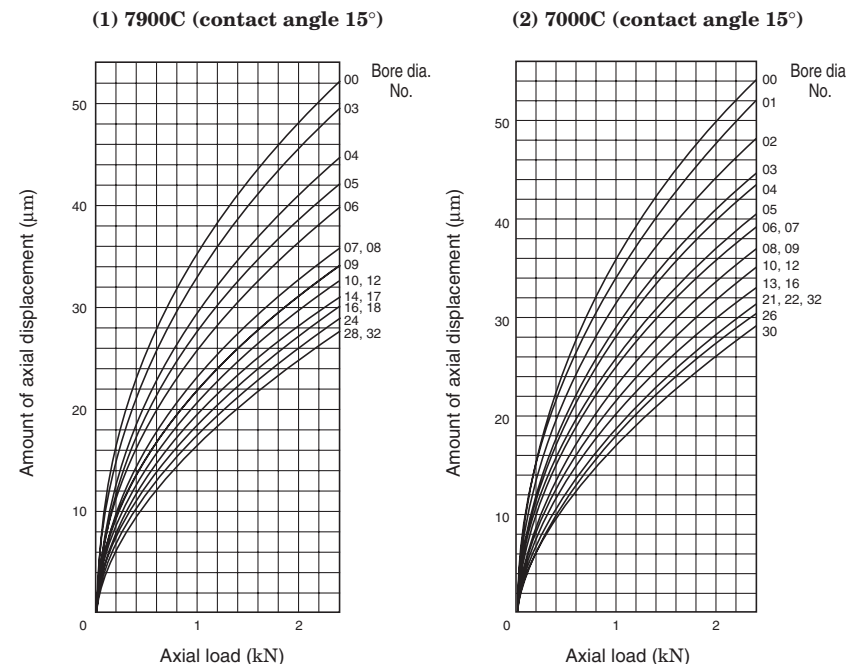



**(3) 7200C (contact angle 15°)**

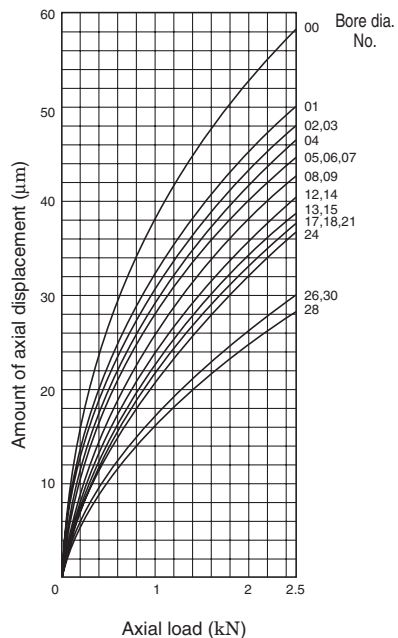

**(6) 7000B (contact angle 40°)**

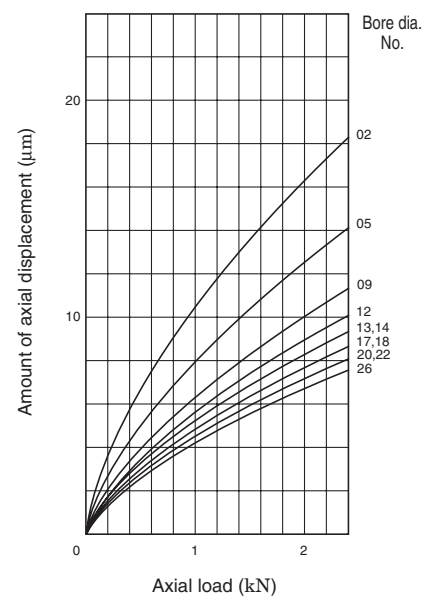

**(7) 7200B (contact angle 40°)**

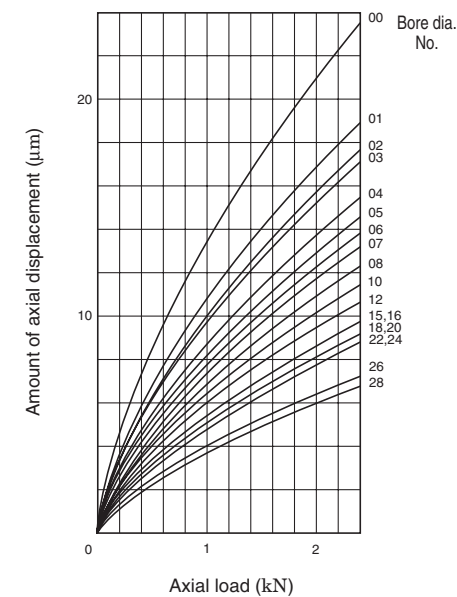

**(4) 7000 (contact angle 30°)**

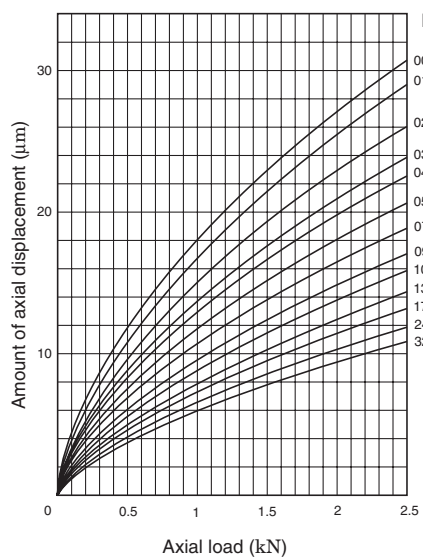

**(5) 7200 (contact angle 30°)**

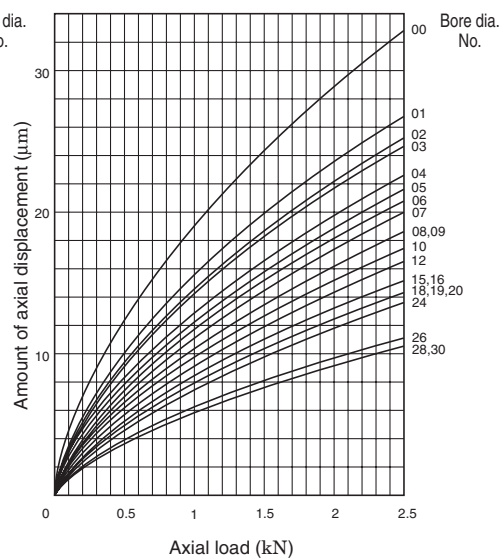

**(8) HAR900C (contact angle 15°)**

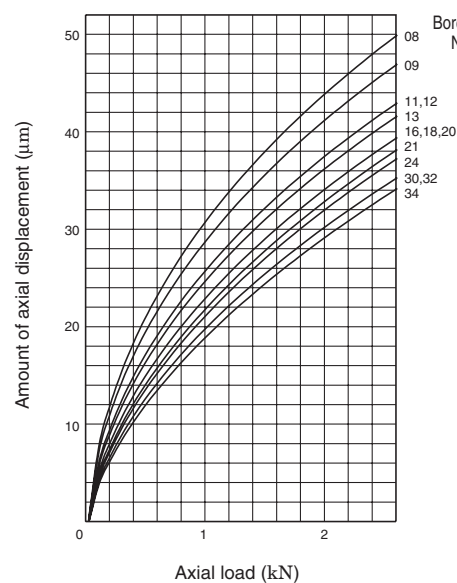

**(9) HAR000C (contact angle 15°)**

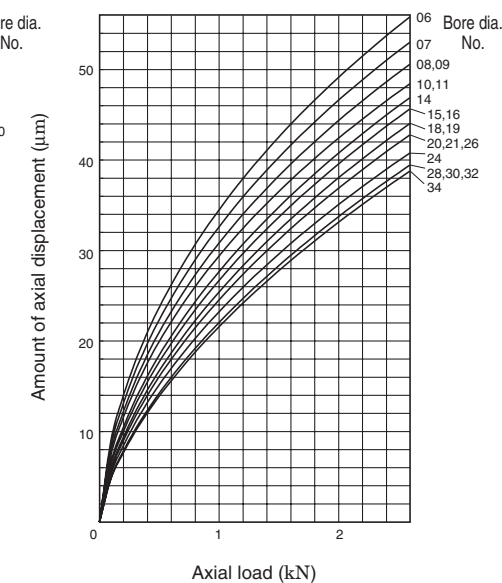

Single-row angular contact ball bearings

$d$  10 ~ (17) mm

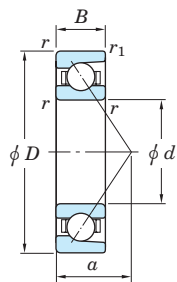

With machined cage

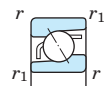

With pressed cage



HAR

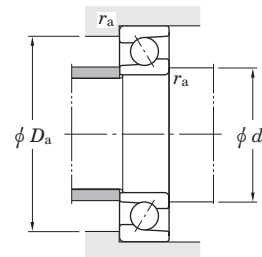

Boundary dimensions (mm)					Basic load ratings (kN)				Factor	Limiting speeds <sup>1)</sup> (min <sup>-1</sup> )		Bearing No. <sup>2)</sup>	Load center (mm) α	Mounting dimensions (mm)			(Refer.) Mass (kg)
$d$	$D$	$B$	$r$ min.	$r_1$ min.	With machined cage		With pressed cage			Grease lub.	Oil lub.			$d_a$ min.	$D_a$ max.	$r_a$ max.	
10	22	6	0.3	0.15	3.00	1.50	—	—	14.2	52 000	69 000	7900C	5.1	12.5	19.5	0.3	0.008
	26	8	0.3	0.15	5.00	2.35	—	—	—	34 000	42 000	7000	9.1	12.5	23.5	0.3	0.021
	26	8	0.3	0.15	4.65	2.15	—	—	—	25 000	33 000	7000B	11.6	12.5	23.5	0.3	0.021
	26	8	0.3	0.15	5.30	2.45	—	—	12.5	47 000	62 000	7000C	6.4	12.5	23.5	0.3	0.021
	30	9	0.6	0.3	4.65	2.20	5.40	2.75	—	29 000	37 000	7200	10.4	14.5	25.5	0.6	0.031
	30	9	0.6	0.3	4.30	2.00	4.95	2.50	—	22 000	29 000	7200B	13.1	14.5	25.5	0.6	0.031
	30	9	0.6	0.3	5.00	2.35	5.80	2.95	13.4	40 000	54 000	7200C	7.2	14.5	25.5	0.6	0.031
	35	11	0.6	0.3	8.50	3.75	9.30	4.30	—	27 000	33 000	7300	12.0	14.5	30.5	0.6	0.054
12	24	6	0.3	0.15	3.20	1.70	—	—	14.7	48 000	62 000	7901C	5.4	14.5	21.5	0.3	0.010
	28	8	0.3	0.15	5.40	2.75	—	—	—	29 000	37 000	7001	9.9	14.5	25.5	0.3	0.024
	28	8	0.3	0.15	4.95	2.50	—	—	—	22 000	29 000	7001B	12.6	14.5	25.5	0.3	0.024
	28	8	0.3	0.15	5.80	2.95	—	—	13.4	40 000	54 000	7001C	6.7	14.5	25.5	0.3	0.024
	32	10	0.6	0.3	7.45	3.65	8.00	4.05	—	27 000	34 000	7201	11.4	16.5	27.5	0.6	0.038
	32	10	0.6	0.3	6.95	3.40	7.40	3.75	—	20 000	27 000	7201B	14.2	16.5	27.5	0.6	0.038
	32	10	0.6	0.3	7.90	3.85	8.50	4.30	12.5	38 000	50 000	7201C	7.9	16.5	27.5	0.6	0.038
	37	12	1	0.6	10.2	4.60	11.2	5.25	—	24 000	31 000	7301	13.1	17.5	31.5	1	0.065
15	28	7	0.3	0.15	4.75	2.65	—	—	14.5	39 000	52 000	7902C	6.4	17.5	25.5	0.3	0.015
	32	9	0.3	0.15	6.10	3.45	—	—	—	26 000	32 000	7002	11.3	17.5	29.5	0.3	0.035
	32	9	0.3	0.15	5.55	3.15	—	—	—	19 000	25 000	7002B	14.6	17.5	29.5	0.3	0.035
	32	9	0.3	0.15	6.60	3.70	—	—	14.1	35 000	47 000	7002C	7.6	17.5	29.5	0.3	0.035
	35	11	0.6	0.3	8.10	4.25	8.10	4.25	—	24 000	29 000	7202	12.9	19.5	30.5	0.6	0.048
	35	11	0.6	0.3	7.45	3.95	7.45	3.95	—	18 000	24 000	7202B	16.2	19.5	30.5	0.6	0.048
	35	11	0.6	0.3	8.65	4.55	8.65	4.55	13.3	33 000	43 000	7202C	8.9	19.5	30.5	0.6	0.048
	42	13	1	0.6	12.5	6.45	13.4	7.20	—	20 000	25 000	7302	15.0	20.5	36.5	1	0.088
17	30	7	0.3	0.15	5.00	2.95	—	—	14.9	36 000	47 000	7903C	6.7	19.5	27.5	0.3	0.016
	35	10	0.3	0.15	6.75	4.15	—	—	—	23 000	28 000	7003	12.7	19.5	32.5	0.3	0.045

[Notes] 1) Limiting speeds shown above are applicable to machined cage bearings. Limiting speeds of pressed cage bearings should be kept to under 80% of this value. For bearings with 15° contact angle, this figure is applied to the high precision bearings ranked higher than class 5, used with machined cage or molded cage.

2) B, C or no indication after the bearing number indicates nominal contact angle of 40°, 15° and 30° respectively. [Remark] Standard cage types used for the above bearings are described earlier in this section.

Single-row angular contact ball bearings

d (17) ~ (25) mm

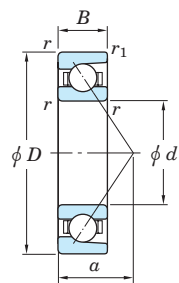

With machined cage

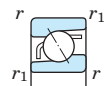

With pressed cage



HAR

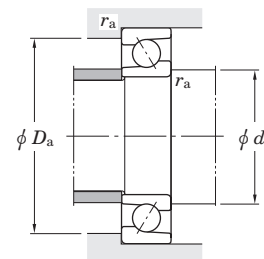

Boundary dimensions (mm)					Basic load ratings (kN)				Factor	Limiting speeds <sup>1)</sup> (min <sup>-1</sup> )		Bearing No. <sup>2)</sup>	Load center (mm) α	Mounting dimensions (mm)			(Refer.) Mass (kg)	
d	D	B	r min.	r1 min.	With machined cage		With pressed cage			Grease lub.	Oil lub.			da min.	Da max.	ra max.		
17	35	10	0.3	0.15	6.10	3.75	—	—	—	17 000	23 000	7003B	16.1	19.5	32.5	0.3	0.045	
	35	10	0.3	0.15	7.30	4.45	—	—	14.6	31 000	41 000	7003C	8.6	19.5	32.5	0.3	0.045	
	40	12	0.6	0.3	10.2	5.50	10.2	5.50	—	21 000	26 000	7203	14.4	21.5	35.5	0.6	0.070	
	40	12	0.6	0.3	9.35	5.05	9.35	5.05	—	16 000	21 000	7203B	18.2	21.5	35.5	0.6	0.070	
	40	12	0.6	0.3	10.9	5.90	10.9	5.90	13.4	29 000	38 000	7203C	9.9	21.5	35.5	0.6	0.070	
	47	14	1	0.6	14.9	7.90	16.0	8.75	—	18 000	23 000	7303	16.5	22.5	41.5	1	0.120	
	47	14	1	0.6	13.8	7.30	14.8	8.10	—	14 000	18 000	7303B	20.8	22.5	41.5	1	0.120	
	47	14	1	0.6	15.8	8.40	15.8	8.40	12.6	25 000	33 000	7303C	11.4	22.5	41.5	1	0.120	
20	37	9	0.3	0.15	7.30	4.55	—	—	14.9	30 000	39 000	7904C	8.3	22.5	34.5	0.3	0.035	
	42	12	0.6	0.3	10.3	6.10	—	—	—	19 000	24 000	7004	15.1	24.5	37.5	0.6	0.079	
	42	12	0.6	0.3	9.35	5.55	—	—	—	14 000	19 000	7004B	19.2	24.5	37.5	0.6	0.079	
	42	12	0.6	0.3	11.1	6.60	—	—	14.1	26 000	35 000	7004C	10.2	24.5	37.5	0.6	0.079	
	47	14	1	0.6	14.5	8.40	15.4	9.15	—	17 000	22 000	7204	17.0	25.5	41.5	1	0.112	
	47	14	1	0.6	13.3	7.70	14.1	8.40	—	13 000	17 000	7204B	21.5	25.5	41.5	1	0.112	
	47	14	1	0.6	15.5	9.00	16.5	9.80	13.4	24 000	32 000	7204C	11.6	25.5	41.5	1	0.112	
	52	15	1.1	0.6	17.4	9.40	18.7	10.4	—	17 000	21 000	7304	17.9	27	45	1	0.150	
	52	15	1.1	0.6	16.2	8.70	17.3	9.65	—	13 000	17 000	7304B	22.6	27	45	1	0.150	
	52	15	1.1	0.6	18.5	9.95	19.9	11.1	12.6	23 000	31 000	7304C	12.3	27	45	1	0.150	
	72	19	1.1	0.6	35.6	19.1	—	—	—	9 600	13 000	7404	23.1	27	65	1	0.395	
	72	19	1.1	0.6	33.5	17.9	—	—	—	8 500	12 000	7404B	29.2	27	65	1	0.395	
	25	42	9	0.3	0.15	7.80	5.45	—	—	15.5	25 000	33 000	7905C	9.1	27.5	39.5	0.3	0.041
		47	12	0.6	0.3	11.3	7.40	—	—	—	17 000	21 000	7005	16.4	29.5	42.5	0.6	0.091
47		12	0.6	0.3	10.2	6.70	—	—	—	12 000	17 000	7005B	21.1	29.5	42.5	0.6	0.091	
47		12	0.6	0.3	12.3	8.00	—	—	14.7	23 000	30 000	7005C	10.8	29.5	42.5	0.6	0.091	
52		15	1	0.6	15.3	9.50	16.2	10.3	—	15 000	19 000	7205	18.8	30.5	46.5	1	0.135	
52		15	1	0.6	14.0	8.70	14.7	9.40	—	12 000	15 000	7205B	23.9	30.5	46.5	1	0.135	
52		15	1	0.6	16.6	10.2	17.5	11.1	14.0	21 000	28 000	7205C	12.7	30.5	46.5	1	0.135	

[Notes] 1) Limiting speeds shown above are applicable to machined cage bearings. Limiting speeds of pressed cage bearings should be kept to under 80% of this value. For bearings with 15° contact angle, this figure is applied to the high precision bearings ranked higher than class 5, used with machined cage or molded cage.

2) B, C or no indication after the bearing number indicates nominal contact angle of 40°, 15° and 30° respectively. [Remark] Standard cage types used for the above bearings are described earlier in this section.

Single-row angular contact ball bearings

d (25) ~ (35) mm

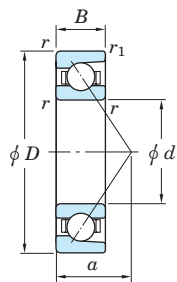

With machined cage

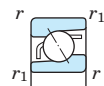

With pressed cage



HAR

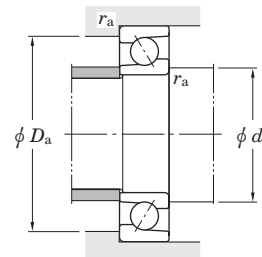

Boundary dimensions (mm)					Basic load ratings (kN)				Factor	Limiting speeds <sup>1)</sup> (min <sup>-1</sup> )		Bearing No. <sup>2)</sup>	Load center (mm) α	Mounting dimensions (mm)			(Refer.) Mass (kg)
d	D	B	r <sub>min.</sub>	r <sub>1 min.</sub>	With machined cage		With pressed cage			Grease lub.	Oil lub.			d <sub>a min.</sub>	D <sub>a max.</sub>	r <sub>a max.</sub>	
25	62	17	1.1	0.6	24.8	14.4	26.4	15.8	—	14 000	17 000	7305	21.1	32	55	1	0.243
	62	17	1.1	0.6	22.9	13.3	24.4	14.6	—	10 000	14 000	7305B	26.8	32	55	1	0.243
	62	17	1.1	0.6	26.4	15.3	28.1	16.8	12.8	19 000	25 000	7305C	14.3	32	55	1	0.243
	80	21	1.5	1	39.7	23.2	42.6	25.7	—	8 200	11 000	7405	26.4	33.5	71.5	1.5	0.527
	80	21	1.5	1	36.9	21.5	39.6	23.9	—	7 300	10 000	7405B	33.6	33.5	71.5	1.5	0.527
30	47	9	0.3	0.15	8.30	6.25	—	—	15.9	22 000	29 000	7906C	9.7	32.5	44.5	0.3	0.046
	55	13	1	0.6	8.70	4.85	—	—	7.9	26 000	40 000	HAR006C	12.2	35.5	49.5	1	0.116
	55	13	1	0.6	14.5	10.1	—	—	—	14 000	18 000	7006	18.8	35.5	49.5	1	0.133
	55	13	1	0.6	13.1	9.20	—	—	—	11 000	14 000	7006B	24.3	35.5	49.5	1	0.133
	55	13	1	0.6	15.8	11.0	—	—	14.9	20 000	26 000	7006C	12.2	35.5	49.5	1	0.133
	62	16	1	0.6	21.3	13.7	22.5	14.8	—	13 000	16 000	7206	21.5	35.5	56.5	1	0.208
	62	16	1	0.6	19.4	12.5	20.5	13.6	—	9 600	13 000	7206B	27.6	35.5	56.5	1	0.208
	62	16	1	0.6	23.0	14.7	24.3	16.0	14.0	18 000	24 000	7206C	14.3	35.5	56.5	1	0.208
	72	19	1.1	0.6	30.1	18.9	31.9	20.6	—	12 000	14 000	7306	24.5	37	65	1	0.362
	72	19	1.1	0.6	27.6	17.4	29.3	19.0	—	8 700	12 000	7306B	31.3	37	65	1	0.362
	72	19	1.1	0.6	32.3	20.3	34.2	22.1	13.4	16 000	21 000	7306C	16.5	37	65	1	0.362
	90	23	1.5	1	47.6	28.4	51.0	31.6	—	7 300	9 700	7406	29.3	38.5	81.5	1.5	0.686
	90	23	1.5	1	44.2	26.4	47.4	29.3	—	6 500	8 900	7406B	37.3	38.5	81.5	1.5	0.686
35	55	10	0.6	0.3	12.5	9.70	—	—	15.7	19 000	25 000	7907C	11.0	39.5	50.5	0.6	0.074
	62	14	1	0.6	9.25	5.55	—	—	8.1	23 000	35 000	HAR007C	13.5	40.5	56.5	1	0.158
	62	14	1	0.6	17.5	12.6	—	—	—	12 000	15 000	7007	21.2	40.5	56.5	1	0.170
	62	14	1	0.6	15.8	11.4	—	—	—	9 200	12 000	7007B	27.6	40.5	56.5	1	0.170
	62	14	1	0.6	19.1	13.7	—	—	15.0	17 000	22 000	7007C	13.5	40.5	56.5	1	0.170
	72	17	1.1	0.6	28.1	18.6	29.7	20.2	—	11 000	14 000	7207	24.2	42	65	1	0.295
	72	17	1.1	0.6	25.6	17.0	27.0	18.5	—	8 300	11 000	7207B	31.4	42	65	1	0.295
	72	17	1.1	0.6	30.4	20.1	32.1	21.7	14.0	15 000	20 000	7207C	15.8	42	65	1	0.295
	80	21	1.5	1	35.4	22.0	39.9	26.4	—	10 000	13 000	7307	27.4	43.5	71.5	1.5	0.475

[Notes] 1) Limiting speeds shown above are applicable to machined cage bearings. Limiting speeds of pressed cage bearings should be kept to under 80% of this value. For bearings with 15° contact angle, this figure is applied to the high precision bearings ranked higher than class 5, used with machined cage or molded cage.

2) B, C or no indication after the bearing number indicates nominal contact angle of 40°, 15° and 30° respectively.

[Remark] Standard cage types used for the above bearings are described earlier in this section.

Single-row angular contact ball bearings

d (35) ~ (45) mm

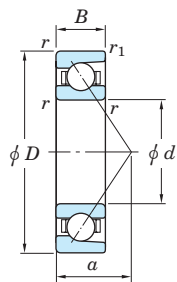

With machined cage

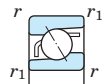

With pressed cage



HAR

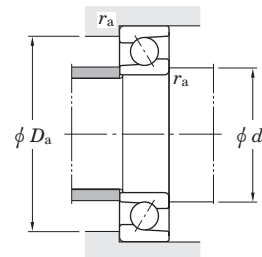

Boundary dimensions (mm)					Basic load ratings (kN)				Factor	Limiting speeds <sup>1)</sup> (min <sup>-1</sup> )		Bearing No. <sup>2)</sup>	Load center (mm) α	Mounting dimensions (mm)			(Refer.) Mass (kg)
d	D	B	r min.	r1 min.	With machined cage		With pressed cage			Grease lub.	Oil lub.			da min.	Da max.	ra max.	
35	80	21	1.5	1	32.5	20.2	36.6	24.3	—	7 700	10 000	7307B	35.0	43.5	71.5	1.5	0.475
	80	21	1.5	1	37.9	23.6	42.8	28.3	13.4	14 000	19 000	7307C	18.3	43.5	71.5	1.5	0.475
	100	25	1.5	1	60.4	37.0	64.8	41.1	—	6 500	8 600	7407	32.6	43.5	91.5	1.5	0.950
	100	25	1.5	1	56.2	34.3	60.2	38.1	—	5 700	7 900	7407B	41.7	43.5	91.5	1.5	0.950
40	62	12	0.6	0.3	15.7	12.4	—	—	15.7	17 000	22 000	7908C	12.8	44.5	57.5	0.6	0.107
	62	12	0.6	0.3	6.35	4.05	—	—	8.4	22 000	33 000	HAR908C	12.8	44.5	57.5	0.6	0.115
	68	15	1	0.6	9.70	6.20	—	—	8.2	20 000	31 000	HAR008C	14.7	45.5	62.5	1	0.200
	68	15	1	0.6	18.7	14.6	—	—	—	11 000	14 000	7008	23.2	45.5	62.5	1	0.210
	68	15	1	0.6	16.8	13.2	—	—	—	8 300	11 000	7008B	30.2	45.5	62.5	1	0.210
	68	15	1	0.6	20.5	15.9	—	—	15.4	15 000	20 000	7008C	14.8	45.5	62.5	1	0.210
	80	18	1.1	0.6	33.6	23.3	35.3	25.1	—	10 000	12 000	7208	26.3	47	73	1	0.382
	80	18	1.1	0.6	30.6	21.3	32.1	23.0	—	7 500	10 000	7208B	34.2	47	73	1	0.382
	80	18	1.1	0.6	36.4	25.2	38.2	27.1	14.2	14 000	18 000	7208C	17.0	47	73	1	0.382
	90	23	1.5	1	43.2	27.4	48.8	32.9	—	9 200	12 000	7308	30.3	48.5	81.5	1.5	0.657
	90	23	1.5	1	39.7	25.2	44.8	30.3	—	6 900	9 200	7308B	38.8	48.5	81.5	1.5	0.657
	90	23	1.5	1	46.3	29.4	52.3	35.3	13.4	13 000	17 000	7308C	20.2	48.5	81.5	1.5	0.657
110	27	2	1	69.9	43.5	75.0	48.4	—	5 900	7 900	7408	35.5	50	100	2	1.23	
110	27	2	1	64.9	40.4	69.6	44.9	—	5 200	7 200	7408B	45.4	50	100	2	1.23	
45	68	12	0.6	0.3	16.6	14.1	—	—	16.0	15 000	20 000	7909C	13.6	49.5	63.5	0.6	0.127
	68	12	0.6	0.3	6.80	4.70	—	—	8.5	19 000	30 000	HAR909C	13.6	49.5	63.5	0.6	0.136
	75	16	1	0.6	10.9	7.10	—	—	8.3	18 000	28 000	HAR009C	16.0	50.5	69.5	1	0.251
	75	16	1	0.6	22.2	17.7	—	—	—	10 000	12 000	7009	25.3	50.5	69.5	1	0.260
	75	16	1	0.6	20.0	16.0	—	—	—	7 500	10 000	7009B	33.2	50.5	69.5	1	0.260
	75	16	1	0.6	24.4	19.3	—	—	15.4	14 000	18 000	7009C	16.0	50.5	69.5	1	0.260
	85	19	1.1	0.6	37.7	26.6	39.6	28.6	—	9 400	12 000	7209	28.0	52	78	1	0.430
	85	19	1.1	0.6	34.3	24.3	36.1	26.1	—	7 000	9 400	7209B	36.4	52	78	1	0.430
	85	19	1.1	0.6	40.8	28.7	42.9	30.9	14.2	13 000	17 000	7209C	18.1	52	78	1	0.430

[Notes] 1) Limiting speeds shown above are applicable to machined cage bearings. Limiting speeds of pressed cage bearings should be kept to under 80% of this value. For bearings with 15° contact angle, this figure is applied to the high precision bearings ranked higher than class 5, used with machined cage or molded cage.

2) B, C or no indication after the bearing number indicates nominal contact angle of 40°, 15° and 30° respectively.

[Remark] Standard cage types used for the above bearings are described earlier in this section.

Single-row angular contact ball bearings

d (45) ~ (55) mm

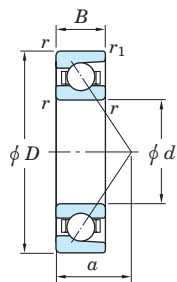

With machined cage

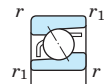

With pressed cage



HAR

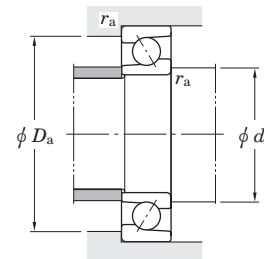

Boundary dimensions (mm)					Basic load ratings (kN)				Factor	Limiting speeds <sup>1)</sup> (min <sup>-1</sup> )		Bearing No. <sup>2)</sup>	Load center (mm) α	Mounting dimensions (mm)			(Refer.) Mass (kg)
d	D	B	r <sub>min.</sub>	r <sub>1 min.</sub>	With machined cage		With pressed cage			Grease lub.	Oil lub.			d <sub>a min.</sub>	D <sub>a max.</sub>	r <sub>a max.</sub>	
45	100	25	1.5	1	55.1	37.1	58.4	40.4	—	8 200	10 000	7309	33.6	53.5	91.5	1.5	0.875
	100	25	1.5	1	50.6	34.1	53.6	37.2	—	6 200	8 200	7309B	43.1	53.5	91.5	1.5	0.875
	100	25	1.5	1	59.2	39.7	62.7	43.4	13.5	11 000	15 000	7309C	22.3	53.5	91.5	1.5	0.875
	120	29	2	1	84.9	53.8	91.1	59.8	—	5 400	7 100	7409	38.6	55	110	2	1.55
	120	29	2	1	78.9	50.0	84.7	55.5	—	4 800	6 600	7409B	49.5	55	110	2	1.55
50	72	12	0.6	0.3	17.4	15.7	—	—	16.2	14 000	18 000	7910C	14.2	54.5	67.5	0.6	0.128
	72	12	0.6	0.3	9.10	6.30	—	—	8.5	18 000	28 000	HAR910C	14.2	54.5	67.5	0.6	0.131
	80	16	1	0.6	11.4	7.85	—	—	8.4	17 000	26 000	HAR010C	16.7	55.5	74.5	1	0.273
	80	16	1	0.6	23.6	20.1	—	—	—	9 200	11 000	7010	26.9	55.5	74.5	1	0.290
	80	16	1	0.6	21.2	18.1	—	—	—	6 900	9 200	7010B	35.3	55.5	74.5	1	0.290
	80	16	1	0.6	26.0	21.9	—	—	15.7	13 000	17 000	7010C	16.8	55.5	74.5	1	0.290
	90	20	1.1	0.6	39.4	29.4	41.3	31.5	—	8 500	11 000	7210	30.4	57	83	1	0.485
	90	20	1.1	0.6	35.7	26.7	37.4	28.6	—	6 400	8 500	7210B	39.6	57	83	1	0.485
	90	20	1.1	0.6	42.8	31.8	44.8	34.1	14.6	12 000	16 000	7210C	19.4	57	83	1	0.485
	110	27	2	1	70.1	48.1	74.3	52.5	—	7 300	9 100	7310	37.2	60	100	2	1.14
	110	27	2	1	64.4	44.3	68.2	48.3	—	5 500	7 300	7310B	47.9	60	100	2	1.14
	110	27	2	1	75.1	51.6	79.6	56.2	13.4	10 000	13 000	7310C	24.5	60	100	2	1.14
	130	31	2.1	1.1	97.4	65.3	—	—	—	4 900	6 600	7410	41.6	62	118	2	1.92
130	31	2.1	1.1	90.2	60.4	—	—	—	4 400	6 000	7410B	53.5	62	118	2	1.92	
55	80	13	1	0.6	19.7	18.5	—	—	16.3	13 000	17 000	7911C	15.5	60.5	74.5	1	0.178
	80	13	1	0.6	10.1	7.65	—	—	8.6	16 000	25 000	HAR911C	15.5	60.5	74.5	1	0.189
	90	18	1.1	0.6	14.1	9.90	—	—	8.4	15 000	23 000	HAR011C	18.7	62	83	1	0.403
	90	18	1.1	0.6	31.1	26.3	—	—	—	8 300	10 000	7011	29.9	62	83	1	0.420
	90	18	1.1	0.6	27.9	23.7	—	—	—	6 200	8 300	7011B	39.4	62	83	1	0.420
	90	18	1.1	0.6	34.1	28.6	—	—	15.5	11 000	15 000	7011C	18.7	62	83	1	0.420
	100	21	1.5	1	48.7	37.1	51.0	39.8	—	7 600	9 500	7211	33.3	63.5	91.5	1.5	0.635
	100	21	1.5	1	44.1	33.8	46.2	36.2	—	5 700	7 600	7211B	43.6	63.5	91.5	1.5	0.635

[Notes] 1) Limiting speeds shown above are applicable to machined cage bearings. Limiting speeds of pressed cage bearings should be kept to under 80% of this value. For bearings with 15° contact angle, this figure is applied to the high precision bearings ranked higher than class 5, used with machined cage or molded cage.

2) B, C or no indication after the bearing number indicates nominal contact angle of 40°, 15° and 30° respectively.

[Remark] Standard cage types used for the above bearings are described earlier in this section.

Single-row angular contact ball bearings

d (55) ~ (65) mm

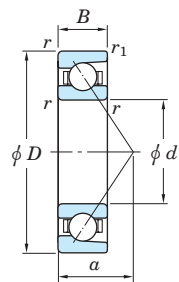

With machined cage

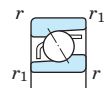

With pressed cage



HAR

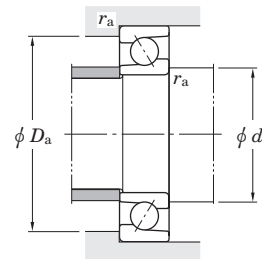

Boundary dimensions (mm)					Basic load ratings (kN)				Factor	Limiting speeds <sup>1)</sup> (min <sup>-1</sup> )		Bearing No. <sup>2)</sup>	Load center (mm) α	Mounting dimensions (mm)			(Refer.) Mass (kg)
d	D	B	r <sub>min.</sub>	r <sub>1 min.</sub>	With machined cage		With pressed cage			Grease lub.	Oil lub.			d <sub>a min.</sub>	D <sub>a max.</sub>	r <sub>a max.</sub>	
55	100	21	1.5	1	52.9	40.2	55.4	43.1	14.6	11 000	14 000	7211C	21.1	63.5	91.5	1.5	0.635
	120	29	2	1	80.9	56.5	85.8	61.7	—	6 700	8 400	7311	40.2	65	110	2	1.45
	120	29	2	1	74.3	52.0	78.7	56.7	—	5 000	6 700	7311B	51.8	65	110	2	1.45
	120	29	2	1	86.8	60.6	91.9	66.1	13.4	9 300	12 000	7311C	26.4	65	110	2	1.45
	140	33	2.1	1.1	118	82.4	—	—	—	4 500	6 000	7411	45.0	67	128	2	2.36
	140	33	2.1	1.1	110	76.5	—	—	—	4 000	5 500	7411B	57.8	67	128	2	2.36
60	85	13	1	0.6	23.2	21.8	—	—	16.3	12 000	16 000	7912C	16.3	65.5	79.5	1	0.187
	85	13	1	0.6	9.95	7.75	—	—	8.6	15 000	23 000	HAR912C	16.2	65.5	79.5	1	0.202
	95	18	1.1	0.6	14.7	10.8	—	—	8.5	14 000	22 000	HAR012C	19.4	67	88	1	0.433
	95	18	1.1	0.6	31.9	28.1	—	—	—	7 700	9 700	7012	31.4	67	88	1	0.450
	95	18	1.1	0.6	28.6	25.3	—	—	—	5 800	7 700	7012B	41.5	67	88	1	0.450
	95	18	1.1	0.6	35.0	30.6	—	—	15.7	11 000	14 000	7012C	19.4	67	88	1	0.450
	110	22	1.5	1	58.9	45.7	61.7	49.0	—	6 900	8 600	7212	36.1	68.5	101.5	1.5	0.820
	110	22	1.5	1	53.4	41.6	55.9	44.6	—	5 100	6 900	7212B	47.5	68.5	101.5	1.5	0.820
	110	22	1.5	1	64.0	49.5	67.0	53.0	14.5	9 500	13 000	7212C	22.7	68.5	101.5	1.5	0.820
	130	31	2.1	1.1	92.5	65.6	98.1	71.6	—	6 200	7 700	7312	43.2	72	118	2	1.81
	130	31	2.1	1.1	84.9	60.3	90.0	65.8	—	4 600	6 200	7312B	55.8	72	118	2	1.81
	130	31	2.1	1.1	99.2	70.3	105	76.7	13.4	8 600	11 000	7312C	28.4	72	118	2	1.81
	150	35	2.1	1.1	129	93.6	—	—	—	4 100	5 500	7412	48.5	72	138	2	2.85
	150	35	2.1	1.1	119	86.7	—	—	—	3 700	5 100	7412B	62.6	72	138	2	2.85
65	90	13	1	0.6	20.8	21.2	—	—	16.5	11 000	15 000	7913C	16.9	70.5	84.5	1	0.205
	90	13	1	0.6	11.8	9.45	—	—	8.6	14 000	22 000	HAR913C	16.9	70.5	84.5	1	0.212
	100	18	1.1	0.6	15.3	11.8	—	—	8.5	13 000	21 000	HAR013C	20.1	72	93	1	0.462
	100	18	1.1	0.6	33.7	31.4	—	—	—	7 200	9 000	7013	33.0	72	93	1	0.470
	100	18	1.1	0.6	30.1	28.3	—	—	—	5 400	7 200	7013B	43.8	72	93	1	0.470
	100	18	1.1	0.6	37.1	34.3	—	—	15.9	10 000	13 000	7013C	20.1	72	93	1	0.470
	120	23	1.5	1	67.3	54.2	70.2	57.8	—	6 400	8 000	7213	38.2	73.5	111.5	1.5	1.02

[Notes] 1) Limiting speeds shown above are applicable to machined cage bearings. Limiting speeds of pressed cage bearings should be kept to under 80% of this value. For bearings with 15° contact angle, this figure is applied to the high precision bearings ranked higher than class 5, used with machined cage or molded cage.

2) B, C or no indication after the bearing number indicates nominal contact angle of 40°, 15° and 30° respectively.

[Remark] Standard cage types used for the above bearings are described earlier in this section.

Single-row angular contact ball bearings

d (65) ~ (75) mm

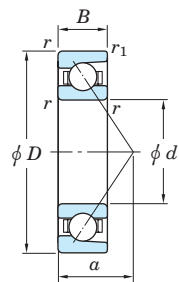

With machined cage

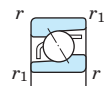

With pressed cage



HAR

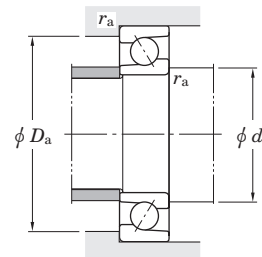

Boundary dimensions (mm)					Basic load ratings (kN)				Factor	Limiting speeds <sup>1)</sup> (min <sup>-1</sup> )		Bearing No. <sup>2)</sup>	Load center (mm) α	Mounting dimensions (mm)			(Refer.) Mass (kg)
d	D	B	r min.	r1 min.	With machined cage		With pressed cage			Grease lub.	Oil lub.			d <sub>a</sub> min.	D <sub>a</sub> max.	r <sub>a</sub> max.	
65	120	23	1.5	1	60.9	49.3	63.6	52.6	—	4 800	6 400	7213B	50.3	73.5	111.5	1.5	1.02
	120	23	1.5	1	73.1	58.7	76.3	62.6	14.6	8 900	12 000	7213C	23.9	73.5	111.5	1.5	1.02
	140	33	2.1	1.1	105	75.3	111	82.2	—	5 800	7 200	7313	46.3	77	128	2	2.22
	140	33	2.1	1.1	96.1	69.3	102	75.6	—	4 300	5 800	7313B	59.7	77	128	2	2.22
	140	33	2.1	1.1	112	80.7	119	88.1	13.4	8 000	11 000	7313C	30.3	77	128	2	2.22
	160	37	2.1	1.1	139	104	—	—	—	3 900	5 200	7413	51.4	77	148	2	3.41
	160	37	2.1	1.1	129	96.8	—	—	—	3 500	4 800	7413B	66.3	77	148	2	3.41
70	100	16	1	0.6	28.9	29.0	—	—	16.4	10 000	12 000	7914C	19.4	75.5	94.5	1	0.332
	100	16	1	0.6	12.9	10.5	—	—	8.7	13 000	20 000	HAR914C	19.4	75.5	94.5	1	0.356
	110	20	1.1	0.6	20.7	15.5	—	—	8.4	12 000	19 000	HAR014C	22.1	77	103	1	0.629
	110	20	1.1	0.6	42.7	39.4	—	—	—	6 600	8 300	7014	36.0	77	103	1	0.660
	110	20	1.1	0.6	38.3	35.5	—	—	—	5 000	6 600	7014B	47.8	77	103	1	0.660
	110	20	1.1	0.6	46.9	43.0	—	—	15.7	9 200	12 000	7014C	22.1	77	103	1	0.660
	125	24	1.5	1	69.8	55.6	76.3	63.5	—	6 100	7 600	7214	40.2	78.5	116.5	1.5	1.12
	125	24	1.5	1	63.2	50.6	69.1	57.8	—	4 600	6 100	7214B	52.9	78.5	116.5	1.5	1.12
	125	24	1.5	1	75.9	60.2	83.0	68.8	14.6	8 400	11 000	7214C	25.1	78.5	116.5	1.5	1.12
	150	35	2.1	1.1	118	85.8	125	93.6	—	5 400	6 700	7314	49.3	82	138	2	2.70
	150	35	2.1	1.1	108	78.9	114	86.0	—	4 000	5 400	7314B	63.7	82	138	2	2.70
	150	35	2.1	1.1	126	91.9	134	100	13.4	7 500	9 900	7314C	32.2	82	138	2	2.70
	180	42	3	1.1	149	115	—	—	—	3 500	4 600	7414	57.6	84	166	2.5	4.99
180	42	3	1.1	148	119	—	—	—	3 100	4 300	7414B	74.2	84	166	2.5	4.99	
75	105	16	1	0.6	29.4	30.5	—	—	16.5	9 300	12 000	7915C	20.1	80.5	99.5	1	0.350
	105	16	1	0.6	13.3	11.2	—	—	8.7	12 000	19 000	HAR915C	20.1	80.5	99.5	1	0.370
	115	20	1.1	0.6	21.1	16.2	—	—	8.5	12 000	18 000	HAR015C	22.7	82	108	1	0.665
	115	20	1.1	0.6	43.6	41.7	—	—	—	6 300	7 800	7015	37.4	82	108	1	0.690
	115	20	1.1	0.6	39.1	37.6	—	—	—	4 700	6 300	7015B	49.9	82	108	1	0.690
	115	20	1.1	0.6	48.0	45.6	—	—	15.9	8 700	11 000	7015C	22.7	82	108	1	0.690

[Notes] 1) Limiting speeds shown above are applicable to machined cage bearings. Limiting speeds of pressed cage bearings should be kept to under 80% of this value. For bearings with 15° contact angle, this figure is applied to the high precision bearings ranked higher than class 5, used with machined cage or molded cage.

2) B, C or no indication after the bearing number indicates nominal contact angle of 40°, 15° and 30° respectively. [Remark] Standard cage types used for the above bearings are described earlier in this section.



Single-row angular contact ball bearings

d (75) ~ (85) mm

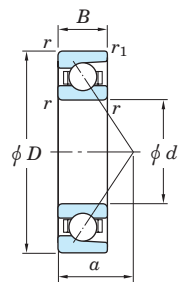

With machined cage

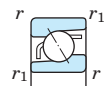

With pressed cage



HAR

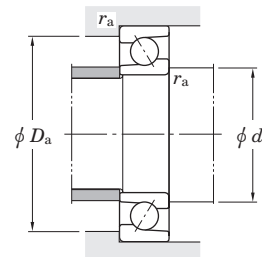

Boundary dimensions (mm)					Basic load ratings (kN)				Factor	Limiting speeds <sup>1)</sup> (min <sup>-1</sup> )		Bearing No. <sup>2)</sup>	Load center (mm) α	Mounting dimensions (mm)			(Refer.) Mass (kg)
d	D	B	r <sub>min.</sub>	r <sub>1 min.</sub>	With machined cage		With pressed cage			Grease lub.	Oil lub.			d <sub>a min.</sub>	D <sub>a max.</sub>	r <sub>a max.</sub>	
75	130	25	1.5	1	79.2	65.2	82.7	69.5	—	5 800	7 200	7215	42.1	83.5	121.5	1.5	1.23
	130	25	1.5	1	71.7	59.3	74.9	63.3	—	4 300	5 800	7215B	55.5	83.5	121.5	1.5	1.23
	130	25	1.5	1	86.1	70.6	89.9	75.3	14.6	8 000	11 000	7215C	26.2	83.5	121.5	1.5	1.23
	160	37	2.1	1.1	128	97.0	136	106	—	5 000	6 300	7315	52.4	87	148	2	3.15
	160	37	2.1	1.1	118	89.2	125	97.3	—	3 800	5 000	7315B	67.8	87	148	2	3.15
	160	37	2.1	1.1	137	104	146	113	13.4	7 000	9 200	7315C	34.2	87	148	2	3.15
	190	45	3	1.1	171	141	—	—	—	3 300	4 400	7415	61.3	89	176	2.5	5.90
	190	45	3	1.1	158	131	—	—	—	2 900	4 000	7415B	78.9	89	176	2.5	5.90
80	110	16	1	0.6	29.8	31.6	—	—	16.5	8 800	11 000	7916C	20.7	85.5	104.5	1	0.368
	110	16	1	0.6	13.6	11.9	—	—	8.8	12 000	18 000	HAR916C	20.7	85.5	104.5	1	0.398
	125	22	1.1	0.6	24.7	19.2	—	—	8.4	10 000	16 000	HAR016C	24.7	87	118	1	0.903
	125	22	1.1	0.6	53.4	50.6	—	—	—	5 800	7 200	7016	40.6	87	118	1	0.930
	125	22	1.1	0.6	47.8	45.7	—	—	—	4 300	5 800	7016B	54.0	87	118	1	0.930
	125	22	1.1	0.6	58.7	55.3	—	—	15.7	8 000	11 000	7016C	24.7	87	118	1	0.930
	140	26	2	1	85.3	71.5	89.0	76.2	—	5 400	6 700	7216	44.8	90	130	2	1.50
	140	26	2	1	77.1	65.0	80.5	69.3	—	4 000	5 400	7216B	59.2	90	130	2	1.50
	140	26	2	1	92.8	77.5	96.9	82.7	14.7	7 500	9 900	7216C	27.7	90	130	2	1.50
	170	39	2.1	1.1	139	109	147	119	—	4 700	5 900	7316	55.6	92	158	2	3.85
	170	39	2.1	1.1	127	100	135	109	—	3 500	4 700	7316B	71.9	92	158	2	3.85
	170	39	2.1	1.1	149	117	158	127	13.5	6 500	8 600	7316C	36.2	92	158	2	3.85
	200	48	3	1.1	193	166	—	—	—	3 100	4 100	7416	65.0	94	186	2.5	6.00
	200	48	3	1.1	179	154	—	—	—	2 700	3 800	7416B	83.6	94	186	2.5	6.00
85	120	18	1.1	0.6	38.9	40.6	—	—	16.5	8 100	11 000	7917C	22.7	92	113	1	0.523
	120	18	1.1	0.6	16.3	14.2	—	—	8.7	10 000	16 000	HAR917C	22.7	92	113	1	0.570
	130	22	1.1	0.6	25.1	20.1	—	—	8.5	9 700	15 000	HAR017C	25.4	92	123	1	0.947
	130	22	1.1	0.6	54.6	53.7	—	—	—	5 500	6 800	7017	42.3	92	123	1	0.970
	130	22	1.1	0.6	48.8	48.4	—	—	—	4 100	5 500	7017B	56.5	92	123	1	0.970

[Notes] 1) Limiting speeds shown above are applicable to machined cage bearings. Limiting speeds of pressed cage bearings should be kept to under 80% of this value. For bearings with 15° contact angle, this figure is applied to the high precision bearings ranked higher than class 5, used with machined cage or molded cage.

2) B, C or no indication after the bearing number indicates nominal contact angle of 40°, 15° and 30° respectively.

[Remark] Standard cage types used for the above bearings are described earlier in this section.

Single-row angular contact ball bearings

d (85) ~ (95) mm

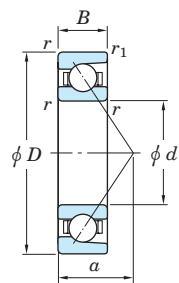

With machined cage

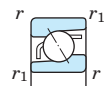

With pressed cage



HAR

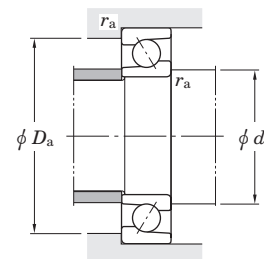

Boundary dimensions (mm)					Basic load ratings (kN)				Factor	Limiting speeds <sup>1)</sup> (min <sup>-1</sup> )		Bearing No. <sup>2)</sup>	Load center (mm) α	Mounting dimensions (mm)			(Refer.) Mass (kg)
d	D	B	r <sub>min.</sub>	r <sub>1 min.</sub>	With machined cage		With pressed cage			Grease lub.	Oil lub.			d <sub>a min.</sub>	D <sub>a max.</sub>	r <sub>a max.</sub>	
85	130	22	1.1	0.6	60.1	58.7	—	—	15.9	7 600	10 000	7017C	25.5	92	123	1	0.970
	150	28	2	1	98.6	83.6	103	89.2	—	5 000	6 300	7217	47.9	95	140	2	1.87
	150	28	2	1	89.2	76.0	93.1	81.1	—	3 800	5 000	7217B	63.3	95	140	2	1.87
	150	28	2	1	107	90.6	112	96.6	14.7	7 000	9 200	7217C	29.7	95	140	2	1.87
	180	41	3	1.1	150	122	159	133	—	4 400	5 500	7317	58.8	99	166	2.5	4.53
	180	41	3	1.1	137	112	145	122	—	3 300	4 400	7317B	76.1	99	166	2.5	4.53
	180	41	3	1.1	161	130	170	142	13.5	6 100	8 100	7317C	38.3	99	166	2.5	4.53
	210	52	4	1.5	204	180	—	—	—	3 000	3 900	7417	68.7	103	192	3	8.54
	210	52	4	1.5	189	167	—	—	—	2 600	3 600	7417B	88.1	103	192	3	8.54
	90	125	18	1.1	0.6	39.6	42.6	—	—	16.6	7 800	10 000	7918C	23.4	97	118	1
125		18	1.1	0.6	16.8	15.1	—	—	8.8	9 700	15 000	HAR918C	23.4	97	118	1	0.598
140		24	1.5	1	32.8	26.1	—	—	8.4	9 100	14 000	HAR018C	27.4	98.5	131.5	1.5	1.21
140		24	1.5	1	65.2	63.3	—	—	—	5 100	6 400	7018	45.2	98.5	131.5	1.5	1.26
140		24	1.5	1	58.4	57.1	—	—	—	3 900	5 100	7018B	60.2	98.5	131.5	1.5	1.26
140		24	1.5	1	71.7	69.1	—	—	15.7	7 100	9 400	7018C	27.4	98.5	131.5	1.5	1.26
160		30	2	1	113	96.7	118	103	—	4 700	5 900	7218	51.1	100	150	2	2.30
160		30	2	1	102	88.0	107	93.8	—	3 500	4 700	7218B	67.4	100	150	2	2.30
160		30	2	1	123	105	128	112	14.6	6 500	8 600	7218C	31.7	100	150	2	2.30
190		43	3	1.1	161	135	171	147	—	4 200	5 200	7318	61.9	104	176	2.5	5.30
190		43	3	1.1	148	124	156	135	—	3 100	4 200	7318B	80.2	104	176	2.5	5.30
190		43	3	1.1	173	145	183	158	13.5	5 800	7 700	7318C	40.3	104	176	2.5	5.30
225		54	4	1.5	216	196	—	—	—	2 800	3 700	7418	72.5	108	207	3	11.4
225		54	4	1.5	200	182	—	—	—	2 500	3 400	7418B	93.1	108	207	3	11.4
95	130	18	1.1	0.6	40.2	44.1	—	—	16.5	7 400	9 800	7919C	24.1	102	123	1	0.574
	130	18	1.1	0.6	17.3	16.0	—	—	8.8	9 300	14 000	HAR919C	24.1	102	123	1	0.626
	145	24	1.5	1	33.4	27.2	—	—	8.5	8 700	13 000	HAR019C	28.1	103.5	136.5	1.5	1.28
	145	24	1.5	1	66.6	67.1	—	—	—	4 800	6 000	7019	47.2	103.5	136.5	1.5	1.32

[Notes] 1) Limiting speeds shown above are applicable to machined cage bearings. Limiting speeds of pressed cage bearings should be kept to under 80% of this value. For bearings with 15° contact angle, this figure is applied to the high precision bearings ranked higher than class 5, used with machined cage or molded cage.

2) B, C or no indication after the bearing number indicates nominal contact angle of 40°, 15° and 30° respectively.

[Remark] Standard cage types used for the above bearings are described earlier in this section.

Single-row angular contact ball bearings

d (95) ~ (105) mm

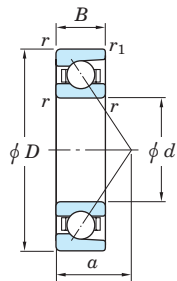

With machined cage

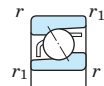

With pressed cage



HAR

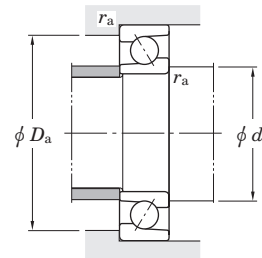

Boundary dimensions (mm)					Basic load ratings (kN)				Factor	Limiting speeds <sup>1)</sup> (min <sup>-1</sup> )		Bearing No. <sup>2)</sup>	Load center (mm) α	Mounting dimensions (mm)			(Refer.) Mass (kg)
d	D	B	r <sub>min.</sub>	r <sub>1 min.</sub>	With machined cage		With pressed cage			Grease lub.	Oil lub.			d <sub>a min.</sub>	D <sub>a max.</sub>	r <sub>a max.</sub>	
95	145	24	1.5	1	59.6	60.5	—	—	—	3 600	4 800	7019B	63.2	103.5	136.5	1.5	1.32
	145	24	1.5	1	73.4	73.4	—	—	15.9	6 700	8 900	7019C	28.3	103.5	136.5	1.5	1.32
	170	32	2.1	1.1	122	103	128	111	—	4 400	5 500	7219	54.3	107	158	2	2.78
	170	32	2.1	1.1	111	94.0	116	101	—	3 300	4 400	7219B	71.6	107	158	2	2.78
	170	32	2.1	1.1	133	112	139	120	14.6	6 100	8 100	7219C	33.8	107	158	2	2.78
	200	45	3	1.1	172	149	183	162	—	4 000	4 900	7319	65.1	109	186	2.5	6.12
	200	45	3	1.1	158	137	167	149	—	3 000	4 000	7319B	84.4	109	186	2.5	6.12
	200	45	3	1.1	185	160	196	174	13.5	5 500	7 300	7319C	42.3	109	186	2.5	6.12
100	140	20	1.1	0.6	55.6	58.5	—	—	16.3	7 000	9 200	7920C	26.1	107	133	1	0.773
	140	20	1.1	0.6	24.2	21.7	—	—	8.7	8 700	13 000	HAR920C	26.1	107	133	1	0.839
	150	24	1.5	1	34.0	28.4	—	—	8.5	8 400	13 000	HAR020C	28.7	108.5	141.5	1.5	1.32
	150	24	1.5	1	68.4	70.6	—	—	—	4 700	5 900	7020	48.1	108.5	141.5	1.5	1.37
	150	24	1.5	1	61.2	63.6	—	—	—	3 500	4 700	7020B	64.4	108.5	141.5	1.5	1.37
	150	24	1.5	1	75.3	77.2	—	—	16.0	6 500	8 600	7020C	28.7	108.5	141.5	1.5	1.37
	180	34	2.1	1.1	137	117	144	126	—	4 100	5 200	7220	57.7	112	168	2	3.32
	180	34	2.1	1.1	124	107	130	115	—	3 100	4 200	7220B	76.2	112	168	2	3.32
	180	34	2.1	1.1	149	127	156	136	14.6	5 700	7 600	7220C	35.9	112	168	2	3.32
	215	47	3	1.1	184	161	207	194	—	3 600	4 600	7320	69.4	114	201	2.5	7.53
	215	47	3	1.1	168	148	190	178	—	2 700	3 600	7320B	90.2	114	201	2.5	7.53
	215	47	3	1.1	197	173	222	208	13.4	5 000	6 700	7320C	44.8	114	201	2.5	7.53
105	145	20	1.1	0.6	56.7	61.5	—	—	16.4	6 700	8 800	7921C	26.7	112	138	1	0.810
	145	20	1.1	0.6	24.9	23.1	—	—	8.7	8 400	13 000	HAR921C	26.7	112	138	1	0.874
	160	26	2	1	38.6	32.5	—	—	8.5	7 900	12 000	HAR021C	30.8	115	150	2	1.68
	160	26	2	1	79.8	81.9	—	—	—	4 400	5 500	7021	51.8	115	150	2	1.73
	160	26	2	1	71.4	73.8	—	—	—	3 300	4 400	7021B	68.6	115	150	2	1.73
	160	26	2	1	87.8	89.6	—	—	15.9	6 000	8 000	7021C	31.0	115	150	2	1.73
	190	36	2.1	1.1	149	132	—	—	—	3 900	4 900	7221	61.0	117	178	2	3.95

[Notes] 1) Limiting speeds shown above are applicable to machined cage bearings. Limiting speeds of pressed cage bearings should be kept to under 80% of this value. For bearings with 15° contact angle, this figure is applied to the high precision bearings ranked higher than class 5, used with machined cage or molded cage.

2) B, C or no indication after the bearing number indicates nominal contact angle of 40°, 15° and 30° respectively.

[Remark] Standard cage types used for the above bearings are described earlier in this section.

Single-row angular contact ball bearings

$d$  (105) ~ (120) mm

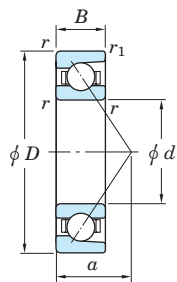

With machined cage

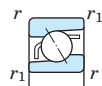

With pressed cage



HAR

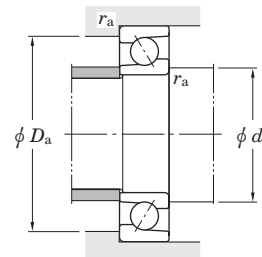

Boundary dimensions (mm)					Basic load ratings (kN)				Factor	Limiting speeds <sup>1)</sup> (min <sup>-1</sup> )		Bearing No. <sup>2)</sup>	Load center (mm) α	Mounting dimensions (mm)			(Refer.) Mass (kg)
$d$	$D$	$B$	$r_{min.}$	$r_{1min.}$	With machined cage		With pressed cage			Grease lub.	Oil lub.			$d_a$ min.	$D_a$ max.	$r_a$ max.	
105	190	36	2.1	1.1	135	121	—	—	—	2 900	3 900	7221B	80.5	117	178	2	3.95
	190	36	2.1	1.1	162	143	—	—	14.6	5 400	7 200	7221C	38.0	117	178	2	3.95
	225	49	3	1.1	208	193	—	—	—	3 500	4 400	7321	72.1	119	211	2.5	8.62
	225	49	3	1.1	191	177	—	—	—	2 600	3 500	7321B	93.7	119	211	2.5	8.62
	225	49	3	1.1	223	207	—	—	13.4	4 800	6 400	7321C	46.6	119	211	2.5	8.62
110	150	20	1.1	0.6	57.7	64.4	—	—	16.5	6 400	8 500	7922C	27.4	117	143	1	0.840
	150	20	1.1	0.6	25.1	23.8	—	—	8.7	8 000	12 000	HAR922C	27.4	117	143	1	0.909
	170	28	2	1	43.4	37.0	—	—	8.5	7 500	12 000	HAR022C	32.8	120	160	2	2.11
	170	28	2	1	91.9	92.8	—	—	—	4 200	5 200	7022	54.4	120	160	2	2.14
	170	28	2	1	82.3	83.7	—	—	—	3 100	4 200	7022B	72.7	120	160	2	2.14
	170	28	2	1	101	101	—	—	15.7	5 800	7 700	7022C	32.8	120	160	2	2.14
	200	38	2.1	1.1	162	148	—	—	—	3 700	4 600	7222	64.3	122	188	2	4.65
	200	38	2.1	1.1	147	135	—	—	—	2 800	3 700	7222B	84.9	122	188	2	4.65
	200	38	2.1	1.1	176	160	—	—	14.5	5 100	6 800	7222C	40.0	122	188	2	4.65
	240	50	3	1.1	232	226	—	—	—	3 200	4 000	7322	76.4	124	226	2.5	10.1
	240	50	3	1.1	213	208	—	—	—	2 400	3 200	7322B	99.6	124	226	2.5	10.1
	240	50	3	1.1	249	242	—	—	13.4	4 500	5 900	7322C	48.8	124	226	2.5	10.1
120	165	22	1.1	0.6	71.7	81.2	—	—	16.5	5 900	7 800	7924C	30.1	127	158	1	1.15
	165	22	1.1	0.6	29.4	28.4	—	—	8.8	7 300	11 000	HAR924C	30.1	127	158	1	1.25
	180	28	2	1	44.9	39.9	—	—	8.5	7 000	11 000	HAR024C	34.1	130	170	2	2.26
	180	28	2	1	96.6	103	—	—	—	3 900	4 900	7024	57.3	130	170	2	2.27
	180	28	2	1	86.4	93.0	—	—	—	2 900	3 900	7024B	76.9	130	170	2	2.27
	180	28	2	1	106	113	—	—	16.0	5 400	7 100	7024C	34.1	130	170	2	2.27
	215	40	2.1	1.1	174	166	—	—	—	3 400	4 300	7224	68.5	132	203	2	5.49
	215	40	2.1	1.1	158	151	—	—	—	2 600	3 400	7224B	90.3	132	203	2	5.49
	215	40	2.1	1.1	190	180	—	—	14.6	4 800	6 300	7224C	42.5	132	203	2	5.49
	260	55	3	1.1	246	252	—	—	—	3 000	3 700	7324	82.3	134	246	2.5	12.6

[Notes] 1) Limiting speeds shown above are applicable to machined cage bearings. Limiting speeds of pressed cage bearings should be kept to under 80% of this value. For bearings with 15° contact angle, this figure is applied to the high precision bearings ranked higher than class 5, used with machined cage or molded cage.

2) B, C or no indication after the bearing number indicates nominal contact angle of 40°, 15° and 30° respectively.

[Remark] Standard cage types used for the above bearings are described earlier in this section.

Single-row angular contact ball bearings

$d$  (120) ~ 140 mm

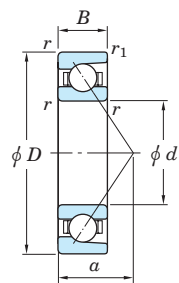

With machined cage

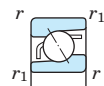

With pressed cage



HAR

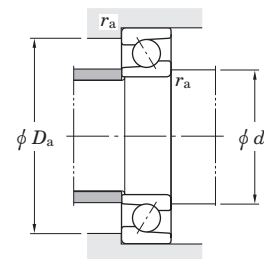

Boundary dimensions (mm)					Basic load ratings (kN)				Factor	Limiting speeds <sup>1)</sup> (min <sup>-1</sup> )		Bearing No. <sup>2)</sup>	Load center (mm) α	Mounting dimensions (mm)			(Refer.) Mass (kg)
$d$	$D$	$B$	$r_{min.}$	$r_{1min.}$	With machined cage		With pressed cage			Grease lub.	Oil lub.			$d_a$ min.	$D_a$ max.	$r_a$ max.	
<b>120</b>	260	55	3	1.1	225	231	—	—	—	2 200	3 000	<b>7324B</b>	107.2	134	246	2.5	12.6
	260	55	3	1.1	265	271	—	—	13.7	4 100	5 500	<b>7324C</b>	53.0	134	246	2.5	12.6
<b>130</b>	180	24	1.5	1	87.2	99.9	—	—	16.4	5 400	7 100	<b>7926C</b>	32.8	138.5	171.5	1.5	1.50
	180	24	1.5	1	35.1	35.1	—	—	8.8	6 700	10 000	<b>HAR926C</b>	32.8	138.5	171.5	1.5	1.66
	200	33	2	1	56.3	48.4	—	—	8.5	6 300	9 800	<b>HAR026C</b>	38.6	140	190	2	3.38
	200	33	2	1	117	125	—	—	—	3 500	4 400	<b>7026</b>	64.1	140	190	2	3.43
	200	33	2	1	105	113	—	—	—	2 600	3 500	<b>7026B</b>	85.7	140	190	2	3.43
	200	33	2	1	129	137	—	—	15.9	4 800	6 400	<b>7026C</b>	38.6	140	190	2	3.43
	230	40	3	1.1	196	198	—	—	—	3 200	4 000	<b>7226</b>	72.0	144	216	2.5	6.21
	230	40	3	1.1	177	180	—	—	—	2 400	3 200	<b>7226B</b>	95.5	144	216	2.5	6.21
	230	40	3	1.1	213	214	—	—	14.7	4 400	5 800	<b>7226C</b>	44.1	144	216	2.5	6.21
	280	58	4	1.5	301	329	—	—	—	2 700	3 400	<b>7326</b>	88.8	148	262	3	15.4
	280	58	4	1.5	250	268	—	—	—	2 100	2 700	<b>7326B</b>	115.0	148	262	3	15.4
	280	58	4	1.5	294	314	—	—	13.7	3 800	5 000	<b>7326C</b>	56.5	148	262	3	15.4
<b>140</b>	190	24	1.5	1	88.3	105	—	—	16.6	5 100	6 700	<b>7928C</b>	34.1	148.5	181.5	1.5	1.59
	190	24	1.5	1	35.2	36.2	—	—	8.8	6 300	9 800	<b>HAR928C</b>	34.1	148.5	181.5	1.5	1.76
	210	33	2	1	61.3	56.2	—	—	8.5	6 000	9 200	<b>HAR028C</b>	39.9	150	200	2	3.62
	210	33	2	1	120	133	—	—	—	3 300	4 100	<b>7028</b>	67.0	150	200	2	3.64
	210	33	2	1	107	119	—	—	—	2 500	3 300	<b>7028B</b>	89.9	150	200	2	3.64
	210	33	2	1	132	145	—	—	16.0	4 500	6 000	<b>7028C</b>	39.9	150	200	2	3.64
	250	42	3	1.1	218	234	—	—	—	2 900	3 600	<b>7228</b>	77.3	154	236	2.5	7.76
	250	42	3	1.1	197	213	—	—	—	2 200	2 900	<b>7228B</b>	102.8	154	236	2.5	7.76
	250	42	3	1.1	238	254	—	—	14.8	4 000	5 300	<b>7228C</b>	47.1	154	236	2.5	7.76
	300	62	4	1.5	329	374	—	—	—	2 500	3 200	<b>7328</b>	94.5	158	282	3	18.8
	300	62	4	1.5	302	344	—	—	—	1 900	2 500	<b>7328B</b>	123.3	158	282	3	18.8
	300	62	4	1.5	353	401	—	—	13.4	3 500	4 600	<b>7328C</b>	60.5	158	282	3	18.8

[Notes] 1) Limiting speeds shown above are applicable to machined cage bearings.  
 Limiting speeds of pressed cage bearings should be kept to under 80% of this value.  
 For bearings with 15° contact angle, this figure is applied to the high precision bearings ranked higher than class 5, used with machined cage or molded cage.

2) B, C or no indication after the bearing number indicates nominal contact angle of 40°, 15° and 30° respectively.  
 [Remark] Standard cage types used for the above bearings are described earlier in this section.

Single-row angular contact ball bearings

d 150 ~ (170) mm

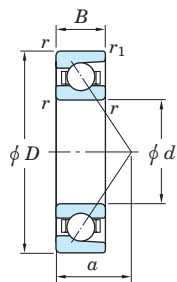

With machined cage

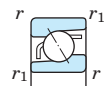

With pressed cage



HAR

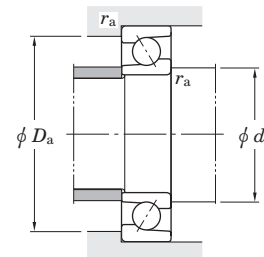

Boundary dimensions (mm)					Basic load ratings (kN)				Factor	Limiting speeds <sup>1)</sup> (min <sup>-1</sup> )		Bearing No. <sup>2)</sup>	Load center (mm) α	Mounting dimensions (mm)			(Refer.) Mass (kg)
d	D	B	r min.	r1 min.	With machined cage		With pressed cage			Grease lub.	Oil lub.			da min.	Da max.	ra max.	
150	210	28	2	1	115	132	—	—	16.3	4 700	6 200	7930C	38.1	160	200	2	2.47
	210	28	2	1	48.9	48.9	—	—	8.7	5 800	9 000	HAR930C	38.1	160	200	2	2.68
	225	35	2	1	72.2	66.1	—	—	8.5	5 300	8 200	HAR030C	42.6	160	215	2	4.36
	225	35	2.1	1.1	137	154	—	—	—	3 000	3 800	7030	72.1	162	213	2	4.43
	225	35	2.1	1.1	122	138	—	—	—	2 300	3 000	7030B	96.2	162	213	2	4.43
	225	35	2.1	1.1	151	169	—	—	16.1	4 200	5 500	7030C	42.8	162	213	2	4.43
	270	45	3	1.1	248	280	—	—	—	2 700	3 300	7230	83.1	164	256	2.5	9.75
	270	45	3	1.1	225	254	—	—	—	2 000	2 700	7230B	110.6	164	256	2.5	9.75
	270	45	3	1.1	270	303	—	—	14.7	3 700	4 900	7230C	50.6	164	256	2.5	9.75
	320	65	4	1.5	348	414	—	—	—	2 300	2 900	7330	100.3	168	302	3	22.4
	320	65	4	1.5	318	380	—	—	—	1 800	2 300	7330B	131.1	168	302	3	22.4
	320	65	4	1.5	374	445	—	—	13.7	3 200	4 300	7330C	64.0	168	302	3	22.4
160	220	28	2	1	120	144	—	—	16.5	4 400	5 800	7932C	39.5	170	210	2	2.60
	220	28	2	1	50.2	51.8	—	—	8.8	5 200	8 100	HAR932C	39.5	170	210	2	2.83
	240	38	2.1	1.1	78.3	72.7	—	—	8.5	5 000	7 700	HAR032C	45.8	172	228	2	5.40
	240	38	2.1	1.1	155	176	—	—	—	2 800	3 500	7032	76.8	172	228	2	5.45
	240	38	2.1	1.1	139	158	—	—	—	2 100	2 800	7032B	102.9	172	228	2	5.45
	240	38	2.1	1.1	171	193	—	—	16.0	3 900	5 200	7032C	45.8	172	228	2	5.45
	290	48	3	1.1	230	263	—	—	—	2 500	3 100	7232	89.0	174	276	2.5	12.1
	290	48	3	1.1	238	279	—	—	—	1 800	2 500	7232B	118.4	174	276	2.5	12.1
	290	48	3	1.1	287	333	—	—	15.2	3 400	4 500	7232C	54.1	174	276	2.5	12.1
	340	68	4	1.5	365	455	—	—	—	2 200	2 700	7332	106.2	178	322	3	26.4
	340	68	4	1.5	332	416	—	—	—	1 600	2 200	7332B	138.9	178	322	3	26.4
	340	68	4	1.5	394	490	—	—	14.0	3 000	4 000	7332C	67.5	168.5	322	3	26.4
170	230	28	2	1	122	151	—	—	16.6	3 900	5 100	7934C	40.8	180	220	2	3.21
	230	28	2	1	51.4	54.8	—	—	8.8	5 000	7 700	HAR934C	40.8	180	220	2	2.97
	260	42	2.1	1.1	91.8	86.4	—	—	8.5	4 600	7 100	HAR034C	49.8	182	248	2	7.32

[Notes] 1) Limiting speeds shown above are applicable to machined cage bearings.  
 Limiting speeds of pressed cage bearings should be kept to under 80% of this value.  
 For bearings with 15° contact angle, this figure is applied to the high precision bearings ranked higher than class 5, used with machined cage or molded cage.

2) B, C or no indication after the bearing number indicates nominal contact angle of 40°, 15° and 30° respectively.  
 [Remark] Standard cage types used for the above bearings are described earlier in this section.

Single-row angular contact ball bearings

d (170) ~ 190 mm

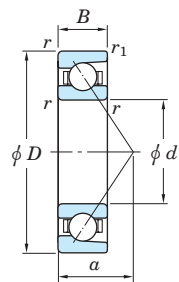

With machined cage

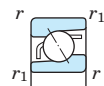

With pressed cage



HAR

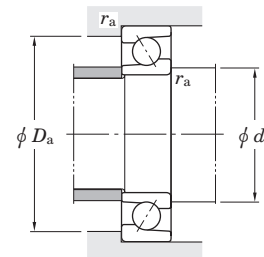

Boundary dimensions (mm)					Basic load ratings (kN)				Factor	Limiting speeds <sup>1)</sup> (min <sup>-1</sup> )		Bearing No. <sup>2)</sup>	Load center (mm) α	Mounting dimensions (mm)			(Refer.) Mass (kg)
d	D	B	r <sub>min.</sub>	r <sub>1 min.</sub>	With machined cage		With pressed cage			Grease lub.	Oil lub.			d <sub>a min.</sub>	D <sub>a max.</sub>	r <sub>a max.</sub>	
170	260	42	2.1	1.1	186	214	—	—	—	2 600	3 200	7034	83.1	182	248	2	7.58
	260	42	2.1	1.1	166	193	—	—	—	1 900	2 600	7034B	111.2	182	248	2	7.77
	260	42	2.1	1.1	204	234	—	—	15.9	3 600	4 800	7034C	49.8	182	248	2	7.57
	310	52	4	1.5	272	331	—	—	—	2 300	2 800	7234	95.3	188	292	3	15.1
	310	52	4	1.5	245	300	—	—	—	1 700	2 300	7234B	126.7	188	292	3	15.1
	310	52	4	1.5	297	359	—	—	15.1	3 100	4 200	7234C	58.2	188	292	3	15.1
	360	72	4	1.5	389	485	—	—	—	2 000	2 500	7334	112.5	188	342	3	31.2
	360	72	4	1.5	355	444	—	—	—	1 500	2 000	7334B	147.2	188	342	3	31.2
	360	72	4	1.5	418	521	—	—	13.8	2 800	3 700	7334C	71.5	188	342	3	31.2
180	250	33	2	1	156	188	—	—	16.4	3 600	4 700	7936C	45.3	190	240	2	4.68
	280	46	2.1	1.1	212	253	—	—	—	2 400	3 000	7036	89.4	192	268	2	10.1
	280	46	2.1	1.1	190	228	—	—	—	1 800	2 400	7036B	119.5	192	268	2	10.2
	280	46	2.1	1.1	233	276	—	—	15.7	3 300	4 400	7036C	53.8	192	268	2	9.96
	320	52	4	1.5	293	362	—	—	—	2 200	2 700	7236	98.2	198	302	3	15.7
	320	52	4	1.5	265	329	—	—	—	1 600	2 200	7236B	130.9	198	302	3	15.7
	320	52	4	1.5	320	393	—	—	14.9	3 000	4 000	7236C	59.5	198	302	3	15.7
	380	75	4	1.5	409	534	—	—	—	1 900	2 400	7336	118.3	198	362	3	40.0
	380	75	4	1.5	373	488	—	—	—	1 400	1 900	7336B	155.0	198	362	3	40.0
	190	260	33	2	1	158	197	—	—	16.5	3 300	4 500	7938C	46.6	200	250	2
290		46	2.1	1.1	217	268	—	—	—	2 300	2 800	7038	92.3	202	278	2	10.8
290		46	2.1	1.1	194	241	—	—	—	1 700	2 300	7038B	123.7	202	278	2	10.8
290		46	2.1	1.1	239	293	—	—	15.9	3 100	4 200	7038C	55.2	202	278	2	10.8
340		55	4	1.5	303	390	—	—	—	2 000	2 500	7238	104.0	208	322	3	18.8
340		55	4	1.5	273	353	—	—	—	1 500	2 000	7238B	138.7	208	322	3	18.8
340		55	4	1.5	331	424	—	—	15.1	2 800	3 700	7238C	63.0	208	322	3	18.8
400		78	5	2	450	598	—	—	—	1 800	2 200	7338	124.2	212	378	4	45.5
400		78	5	2	411	548	—	—	—	1 300	1 800	7338B	162.8	212	378	4	45.5

[Notes] 1) Limiting speeds shown above are applicable to machined cage bearings.  
Limiting speeds of pressed cage bearings should be kept to under 80% of this value.  
For bearings with 15° contact angle, this figure is applied to the high precision bearings ranked higher than class 5, used with machined cage or molded cage.

2) B, C or no indication after the bearing number indicates nominal contact angle of 40°, 15° and 30° respectively.  
[Remark] Standard cage types used for the above bearings are described earlier in this section.

Single-row angular contact ball bearings

d 200 ~ (340) mm

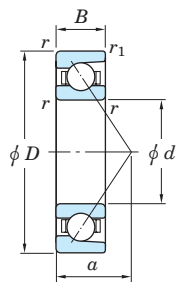

With machined cage

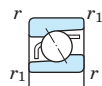

With pressed cage

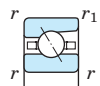

HAR

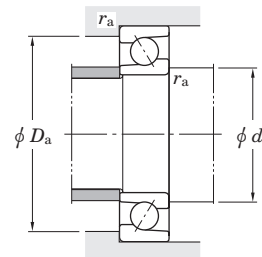

Boundary dimensions (mm)					Basic load ratings (kN)				Factor	Limiting speeds <sup>1)</sup> (min <sup>-1</sup> )		Bearing No. <sup>2)</sup>	Load center (mm) α	Mounting dimensions (mm)			(Refer.) Mass (kg)
d	D	B	r <sub>min.</sub>	r <sub>1 min.</sub>	With machined cage		With pressed cage			Grease lub.	Oil lub.			d <sub>a min.</sub>	D <sub>a max.</sub>	r <sub>a max.</sub>	
					C <sub>r</sub>	C <sub>0r</sub>	C <sub>r</sub>	C <sub>0r</sub>	f <sub>0</sub>								
200	280	38	2.1	1.1	204	255	—	—	16.3	3 100	4 100	7940C	51.2	212	268	2	6.85
	310	51	2.1	1.1	244	309	—	—	—	2 100	2 600	7040	99.1	212	298	2	12.7
	310	51	2.1	1.1	218	279	—	—	—	1 600	2 100	7040B	132.5	212	298	2	12.7
	310	51	2.1	1.1	268	338	—	—	15.7	2 900	3 900	7040C	59.7	212	298	2	12.7
	360	58	4	1.5	324	423	—	—	—	1 900	2 400	7240	109.8	218	342	3	22.4
	360	58	4	1.5	292	384	—	—	—	1 400	1 900	7240B	146.5	218	342	3	22.4
	360	58	4	1.5	354	460	—	—	15.1	2 600	3 500	7240C	66.5	218	342	3	22.4
	420	80	5	2	474	658	—	—	—	1 700	2 100	7340	129.5	222	398	4	52.0
	420	80	5	2	432	602	—	—	—	1 200	1 700	7340B	170.1	222	398	4	52.0
220	340	56	3	1.1	267	353	—	—	—	1 900	2 400	7044	108.9	234	326	2.5	18.5
	340	56	3	1.1	239	318	—	—	—	1 400	1 900	7044B	145.5	234	326	2.5	18.9
240	360	56	3	1.1	273	375	—	—	—	1 700	2 200	7048	114.6	254	346	2.5	19.7
	360	56	3	1.1	244	338	—	—	—	1 300	1 700	7048B	153.9	254	346	2.5	20.1
	440	72	4	1.5	403	595	—	—	—	1 500	1 800	7248	134.2	258	422	3	51.8
	440	72	4	1.5	363	539	—	—	—	1 100	1 500	7248B	178.6	258	422	3	52.8
260	400	65	4	1.5	325	478	—	—	—	1 500	1 900	7052	128.4	278	382	3	28.7
	400	65	4	1.5	291	431	—	—	—	1 100	1 500	7052B	171.0	278	382	3	29.3
280	420	65	4	1.5	332	507	—	—	—	1 400	1 800	7056	133.5	298	402	3	30.4
	420	65	4	1.5	297	453	—	—	—	1 100	1 400	7056B	179.3	298	402	3	31.0
300	460	74	4	1.5	426	680	—	—	—	1 300	1 600	7060	146.7	318	442	3	43.7
	460	74	4	1.5	382	613	—	—	—	960	1 300	7060B	196.4	318	442	3	44.9
320	480	74	4	1.5	437	722	—	—	—	1 200	1 500	7064	152.5	338	462	3	46.0
	480	74	4	1.5	391	651	—	—	—	890	1 200	7064B	204.8	338	462	3	47.2
340	520	82	5	2	502	861	—	—	—	1 100	1 300	7068	165.1	362	498	4	61.8

[Notes] 1) Limiting speeds shown above are applicable to machined cage bearings. Limiting speeds of pressed cage bearings should be kept to under 80% of this value. For bearings with 15° contact angle, this figure is applied to the high precision bearings ranked higher than class 5, used with machined cage or molded cage.

2) B, C or no indication after the bearing number indicates nominal contact angle of 40°, 15° and 30° respectively. [Remark] Standard cage types used for the above bearings are described earlier in this section.



# Single-row angular contact ball bearings

$d$  (340) ~ 380 mm

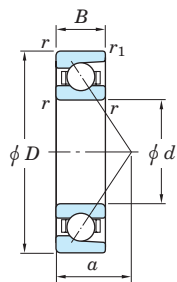

With machined cage

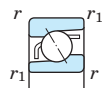

With pressed cage



HAR

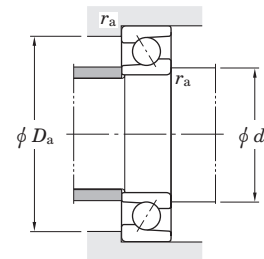

Boundary dimensions (mm)					Basic load ratings (kN)				Factor	Limiting speeds <sup>1)</sup> (min <sup>-1</sup> )		Bearing No. <sup>2)</sup>	Load center (mm) $a$	Mounting dimensions (mm)			(Refer.) Mass (kg)
$d$	$D$	$B$	$r_{min.}$	$r_{1min.}$	With machined cage		With pressed cage			Grease lub.	Oil lub.			$d_a$ min.	$D_a$ max.	$r_a$ max.	
340	520	82	5	2	450	777	—	—	—	800	1 100	7068B	221.4	362	498	4	63.3
	540	82	5	2	461	824	—	—	—	1 000	1 300						
360	540	82	5	2	461	824	—	—	—	750	1 000	7072B	229.8	382	518	4	66.2
	560	82	5	2	528	966	—	—	—	940	1 200						
380	560	82	5	2	472	870	—	—	—	700	940	7076B	238.2	402	538	4	69.1

[Notes] 1) Limiting speeds shown above are applicable to machined cage bearings. Limiting speeds of pressed cage bearings should be kept to under 80% of this value. For bearings with 15° contact angle, this figure is applied to the high precision bearings ranked higher than class 5, used with machined cage or molded cage.

2) B or no indication after the bearing number indicates nominal contact angle of 15° and 30° respectively. [Remark] Standard cage types used for the above bearings are described earlier in this section.

Angular contact ball bearings (matched pair)

d 10 ~ (17) mm

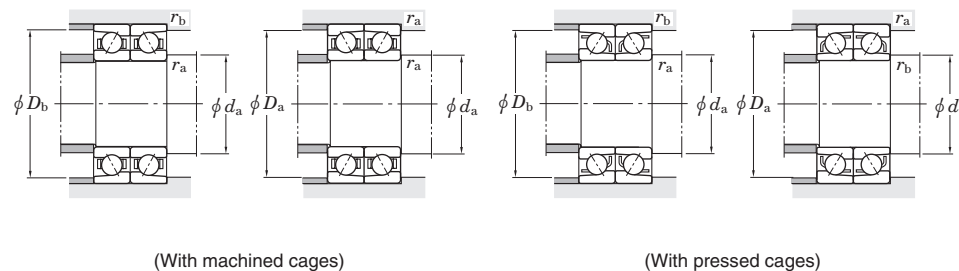
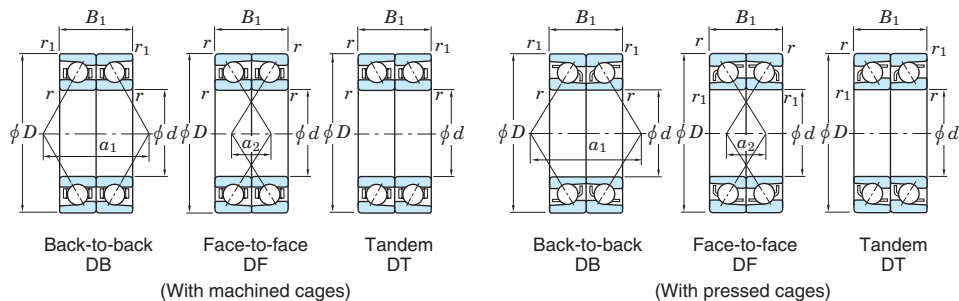

Boundary dimensions (mm)					Basic load ratings (kN)				Factor	Limiting speeds <sup>1)</sup> (min <sup>-1</sup> )		Bearing No. <sup>2)</sup>			Load center spread (mm)		Mounting dimensions (mm)						(Refer.) Mass (kg)
d	D	B <sub>1</sub>	r <sub>min.</sub>	r <sub>1 min.</sub>	With machined cages		With pressed cages			Grease lub.	Oil lub.	Back-to-back DB	Face-to-face DF	Tandem DT	a <sub>1</sub>	a <sub>2</sub>	d <sub>a min.</sub>	d <sub>b min.</sub>	D <sub>a max.</sub>	D <sub>b max.</sub>	r <sub>a max.</sub>	r <sub>b max.</sub>	
10	22	12	0.3	0.15	4.90	3.05	—	—	14.2	42 000	55 000	7900CDB	7900CDF	7900CDT	10.3	1.7	12.5	—	19.5	20.8	0.3	0.15	0.016
	26	16	0.3	0.15	8.10	4.65	—	—	—	27 000	34 000	7000DB	7000DF	7000DT	18.2	2.2	12.5	—	23.5	24.8	0.3	0.15	0.042
	26	16	0.3	0.15	7.55	4.35	—	—	—	20 000	27 000	7000BDB	7000BDF	7000BDT	23.1	7.1	12.5	—	23.5	24.8	0.3	0.15	0.042
	26	16	0.3	0.15	8.60	4.95	—	—	12.5	37 000	50 000	7000CDB	7000CDF	7000CDT	12.7	3.3	12.5	—	23.5	24.8	0.3	0.15	0.042
	30	18	0.6	0.3	7.55	4.40	8.80	5.45	—	23 000	29 000	7200DB	7200DF	7200DT	20.8	2.8	14.5	12.5	25.5	27.5	0.6	0.3	0.062
	30	18	0.6	0.3	6.95	4.05	8.10	5.05	—	18 000	23 000	7200BDB	7200BDF	7200BDT	26.2	8.2	14.5	12.5	25.5	27.5	0.6	0.3	0.062
	30	18	0.6	0.3	8.10	4.70	9.45	5.85	13.4	32 000	43 000	7200CDB	7200CDF	7200CDT	14.5	3.5	14.5	12.5	25.5	27.5	0.6	0.3	0.062
	35	22	0.6	0.3	13.8	7.55	15.1	8.60	—	21 000	27 000	7300DB	7300DF	7300DT	24.0	2.0	14.5	12.5	30.5	32.5	0.6	0.3	0.108
12	24	12	0.3	0.15	5.15	3.45	—	—	14.7	37 000	49 000	7901CDB	7901CDF	7901CDT	10.8	1.2	14.5	—	21.5	22.8	0.3	0.15	0.020
	28	16	0.3	0.15	8.80	5.45	—	—	—	23 000	29 000	7001DB	7001DF	7001DT	19.9	3.9	14.5	—	25.5	26.8	0.3	0.15	0.048
	28	16	0.3	0.15	8.10	5.05	—	—	—	18 000	23 000	7001BDB	7001BDF	7001BDT	25.2	9.2	14.5	—	25.5	26.8	0.3	0.15	0.048
	28	16	0.3	0.15	9.40	5.85	—	—	13.4	32 000	43 000	7001CDB	7001CDF	7001CDT	13.5	2.5	14.5	—	25.5	26.8	0.3	0.15	0.048
	32	20	0.6	0.3	12.1	7.25	13.0	8.05	—	22 000	27 000	7201DB	7201DF	7201DT	22.7	2.7	16.5	14.5	27.5	29.5	0.6	0.3	0.076
	32	20	0.6	0.3	11.3	6.80	12.1	7.50	—	16 000	22 000	7201BDB	7201BDF	7201BDT	28.5	8.5	16.5	14.5	27.5	29.5	0.6	0.3	0.076
	32	20	0.6	0.3	12.8	7.70	13.8	8.55	12.5	30 000	40 000	7201CDB	7201CDF	7201CDT	15.9	4.1	16.5	14.5	27.5	29.5	0.6	0.3	0.076
	37	24	1	0.6	16.6	9.20	18.1	10.5	—	20 000	24 000	7301DB	7301DF	7301DT	26.2	2.2	17.5	16.5	31.5	32.5	1	0.6	0.130
15	28	14	0.3	0.15	7.75	5.30	—	—	14.5	31 000	41 000	7902CDB	7902CDF	7902CDT	12.8	1.2	17.5	—	25.5	26.8	0.3	0.15	0.030
	32	18	0.3	0.15	9.95	6.85	—	—	—	20 000	26 000	7002DB	7002DF	7002DT	22.6	4.6	17.5	—	29.5	30.8	0.3	0.15	0.070
	32	18	0.3	0.15	9.05	6.30	—	—	—	15 000	20 000	7002BDB	7002BDF	7002BDT	29.1	11.1	17.5	—	29.5	30.8	0.3	0.15	0.070
	32	18	0.3	0.15	10.7	7.40	—	—	14.1	28 000	37 000	7002CDB	7002CDF	7002CDT	15.3	2.7	17.5	—	29.5	30.8	0.3	0.15	0.070
	35	22	0.6	0.3	13.2	8.55	13.2	8.55	—	19 000	24 000	7202DB	7202DF	7202DT	25.7	3.7	19.5	17.5	30.5	32.5	0.6	0.3	0.096
	35	22	0.6	0.3	12.1	7.85	12.1	7.85	—	14 000	19 000	7202BDB	7202BDF	7202BDT	32.4	10.4	19.5	17.5	30.5	32.5	0.6	0.3	0.096
	35	22	0.6	0.3	14.1	9.15	14.1	9.15	13.3	26 000	35 000	7202CDB	7202CDF	7202CDT	17.8	4.2	19.5	17.5	30.5	32.5	0.6	0.3	0.096
	42	26	1	0.6	20.3	12.9	21.8	14.4	—	16 000	20 000	7302DB	7302DF	7302DT	30.0	4.0	20.5	19.5	36.5	37.5	1	0.6	0.176
17	30	14	0.3	0.15	8.10	5.90	—	—	14.9	28 000	38 000	7903CDB	7903CDF	7903CDT	13.4	0.6	19.5	—	27.5	28.8	0.3	0.15	0.032
	35	20	0.3	0.15	10.9	8.25	—	—	—	18 000	23 000	7003DB	7003DF	7003DT	25.3	5.3	19.5	—	32.5	33.8	0.3	0.15	0.090

[Notes] 1) Limiting speeds shown above are applicable to machined cage bearings. Limiting speeds of pressed cage bearings should be kept to under 80% of this value. For bearings with 15° contact angle, this figure is applied to the high precision bearings ranked higher than class 5, used with machined cages or molded cages.

2) B, C or no indication after the bearing number indicates nominal contact angle of 40°, 15° and 30° respectively.

[Remark] Standard cage types used for the above bearings are described earlier in this section.

Angular contact ball bearings (matched pair)

d (17) ~ (25) mm

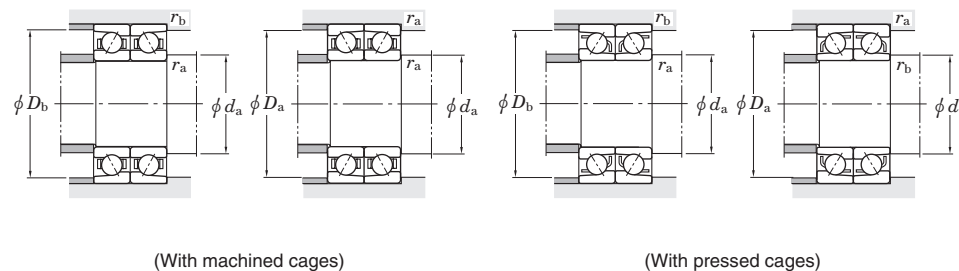
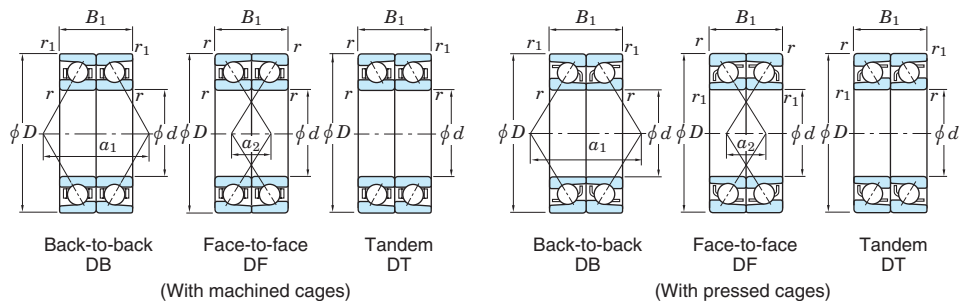

Boundary dimensions (mm)					Basic load ratings (kN)				Factor	Limiting speeds <sup>1)</sup> (min <sup>-1</sup> )		Bearing No. <sup>2)</sup>			Load center spread (mm)		Mounting dimensions (mm)						(Refer.) Mass (kg)
d	D	B <sub>1</sub>	r <sub>min.</sub>	r <sub>1 min.</sub>	With machined cages		With pressed cages			Grease lub.	Oil lub.	Back-to-back DB	Face-to-face DF	Tandem DT	a <sub>1</sub>	a <sub>2</sub>	d <sub>a min.</sub>	d <sub>b min.</sub>	D <sub>a max.</sub>	D <sub>b max.</sub>	r <sub>a max.</sub>	r <sub>b max.</sub>	
17	35	20	0.3	0.15	9.90	7.50	—	—	—	14 000	18 000	7003BDB	7003BDF	7003BDT	32.2	12.2	19.5	—	32.5	33.8	0.3	0.15	0.090
	35	20	0.3	0.15	11.9	8.95	—	—	14.6	25 000	33 000	7003CDB	7003CDF	7003CDT	17.1	2.9	19.5	—	32.5	33.8	0.3	0.15	0.090
	40	24	0.6	0.3	16.5	11.0	16.5	11.0	—	17 000	21 000	7203DB	7203DF	7203DT	28.8	4.8	21.5	19.5	35.5	37.5	0.6	0.3	0.140
	40	24	0.6	0.3	15.2	10.1	15.2	10.1	—	12 000	17 000	7203BDB	7203BDF	7203BDT	36.3	12.3	21.5	19.5	35.5	37.5	0.6	0.3	0.140
	40	24	0.6	0.3	17.7	11.8	17.7	11.8	13.4	23 000	30 000	7203CDB	7203CDF	7203CDT	19.8	4.2	21.5	19.5	35.5	37.5	0.6	0.3	0.140
	47	28	1	0.6	24.2	15.8	26.0	17.5	—	15 000	18 000	7303DB	7303DF	7303DT	33.1	5.1	22.5	21.5	41.5	42.5	1	0.6	0.240
	47	28	1	0.6	22.5	14.6	24.1	16.2	—	11 000	15 000	7303BDB	7303BDF	7303BDT	41.7	13.7	22.5	21.5	41.5	42.5	1	0.6	0.240
	47	28	1	0.6	25.7	16.8	25.7	16.8	12.6	20 000	27 000	7303CDB	7303CDF	7303CDT	22.8	5.2	22.5	21.5	41.5	42.5	1	0.6	0.240
20	37	18	0.3	0.15	11.8	9.15	—	—	14.9	24 000	31 000	7904CDB	7904CDF	7904CDT	16.6	1.4	22.5	—	34.5	35.8	0.3	0.15	0.070
	42	24	0.6	0.3	16.7	12.2	—	—	—	15 000	19 000	7004DB	7004DF	7004DT	30.2	6.2	24.5	—	37.5	39.5	0.6	0.3	0.158
	42	24	0.6	0.3	15.2	11.1	—	—	—	11 000	15 000	7004BDB	7004BDF	7004BDT	38.4	14.4	24.5	—	37.5	39.5	0.6	0.3	0.158
	42	24	0.6	0.3	18.0	13.2	—	—	14.1	21 000	28 000	7004CDB	7004CDF	7004CDT	20.4	3.6	24.5	—	37.5	39.5	0.6	0.3	0.158
	47	28	1	0.6	23.5	16.8	24.9	18.3	—	14 000	17 000	7204DB	7204DF	7204DT	33.9	5.9	25.5	24.5	41.5	42.5	1	0.6	0.224
	47	28	1	0.6	21.6	15.4	22.9	16.8	—	10 000	14 000	7204BDB	7204BDF	7204BDT	42.9	14.9	25.5	24.5	41.5	42.5	1	0.6	0.224
	47	28	1	0.6	25.2	18.0	26.7	19.6	13.4	19 000	26 000	7204CDB	7204CDF	7204CDT	23.2	4.8	25.5	24.5	41.5	42.5	1	0.6	0.224
	52	30	1.1	0.6	28.3	18.8	30.4	20.8	—	13 000	17 000	7304DB	7304DF	7304DT	35.8	5.8	27	24.5	45	47.5	1	0.6	0.300
	52	30	1.1	0.6	26.3	17.4	28.2	19.3	—	10 000	13 000	7304BDB	7304BDF	7304BDT	45.2	15.2	27	24.5	45	47.5	1	0.6	0.300
	52	30	1.1	0.6	30.1	19.9	32.3	22.2	12.6	18 000	24 000	7304CDB	7304CDF	7304CDT	24.6	5.4	27	24.5	45	47.5	1	0.6	0.300
	72	38	1.1	0.6	57.8	38.2	—	—	—	7 400	11 000	7404DB	7404DF	7404DT	46.1	8.1	27	—	65	67.5	1	0.6	0.790
	72	38	1.1	0.6	54.4	35.9	—	—	—	6 400	9 600	7404BDB	7404BDF	7404BDT	58.4	20.4	27	—	65	67.5	1	0.6	0.790
	25	42	18	0.3	0.15	12.7	10.9	—	—	15.5	20 000	27 000	7905CDB	7905CDF	7905CDT	18.2	0.2	27.5	—	39.5	40.8	0.3	0.15
47		24	0.6	0.3	18.3	14.8	—	—	—	13 000	17 000	7005DB	7005DF	7005DT	32.9	8.9	29.5	—	42.5	44.5	0.6	0.3	0.182
47		24	0.6	0.3	16.6	13.4	—	—	—	10 000	13 000	7005BDB	7005BDF	7005BDT	42.3	18.3	29.5	—	42.5	44.5	0.6	0.3	0.182
47		24	0.6	0.3	20.0	16.0	—	—	14.7	18 000	24 000	7005CDB	7005CDF	7005CDT	21.7	2.3	29.5	—	42.5	44.5	0.6	0.3	0.182
52		30	1	0.6	24.9	19.0	26.3	20.6	—	12 000	15 000	7205DB	7205DF	7205DT	37.5	7.5	30.5	29.5	46.5	47.5	1	0.6	0.270
52		30	1	0.6	22.7	17.4	24.0	18.8	—	9 200	12 000	7205BDB	7205BDF	7205BDT	47.7	17.7	30.5	29.5	46.5	47.5	1	0.6	0.270
52		30	1	0.6	26.9	20.5	28.4	22.2	14.0	17 000	23 000	7205CDB	7205CDF	7205CDT	25.5	4.5	30.5	29.5	46.5	47.5	1	0.6	0.270

[Notes] 1) Limiting speeds shown above are applicable to machined cage bearings. Limiting speeds of pressed cage bearings should be kept to under 80% of this value. For bearings with 15° contact angle, this figure is applied to the high precision bearings ranked higher than class 5, used with machined cages or molded cages.

2) B, C or no indication after the bearing number indicates nominal contact angle of 40°, 15° and 30° respectively. [Remark] Standard cage types used for the above bearings are described earlier in this section.

Angular contact ball bearings (matched pair)

d (25) ~ (35) mm

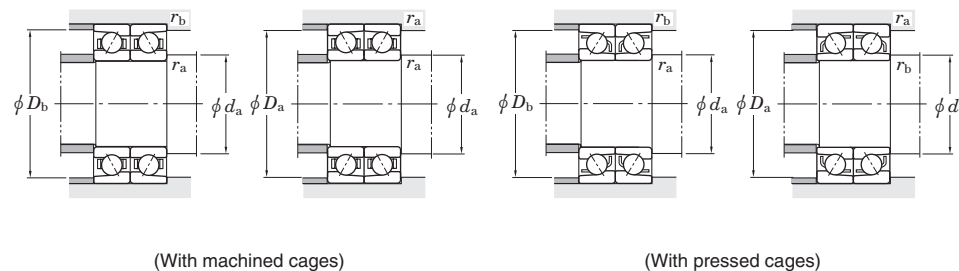
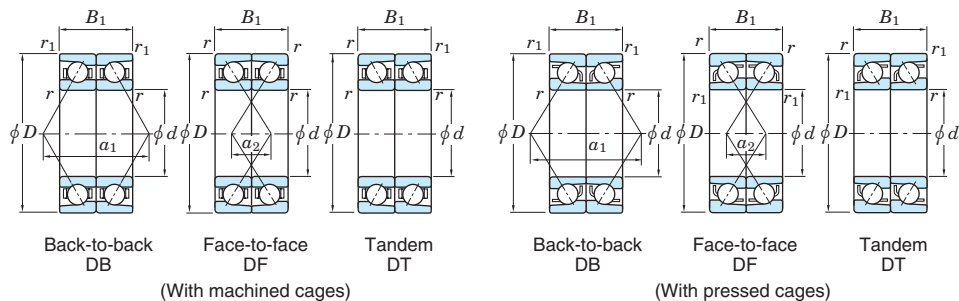

Boundary dimensions (mm)					Basic load ratings (kN)				Factor $f_0$	Limiting speeds <sup>1)</sup> (min <sup>-1</sup> )		Bearing No. <sup>2)</sup>			Load center spread (mm)		Mounting dimensions (mm)						(Refer.) Mass (kg)
$d$	$D$	$B_1$	$r$ min.	$r_1$ min.	With machined cages		With pressed cages			Grease lub.	Oil lub.	Back-to-back DB	Face-to-face DF	Tandem DT	$a_1$	$a_2$	$d_a$ min.	$d_b$ min.	$D_a$ max.	$D_b$ max.	$r_a$ max.	$r_b$ max.	
25	62	34	1.1	0.6	40.3	28.8	42.9	31.6	—	11 000	14 000	7305DB	7305DF	7305DT	42.1	8.1	32	29.5	55	57.5	1	0.6	0.486
	62	34	1.1	0.6	37.2	26.6	39.6	29.2	—	8 300	11 000	7305BDB	7305BDF	7305BDT	53.5	19.5	32	29.5	55	57.5	1	0.6	0.486
	62	34	1.1	0.6	42.8	30.6	45.6	33.7	12.8	15 000	20 000	7305CDB	7305CDF	7305CDT	28.7	5.3	32	29.5	55	57.5	1	0.6	0.486
	80	42	1.5	1	64.5	46.3	69.2	51.5	—	6 400	9 100	7405DB	7405DF	7405DT	52.8	10.8	33.5	30.5	71.5	74.5	1.5	1	1.05
	80	42	1.5	1	60.0	43.0	64.3	47.8	—	5 500	8 200	7405BDB	7405BDF	7405BDT	67.2	25.2	33.5	30.5	71.5	74.5	1.5	1	1.05
30	47	18	0.3	0.15	13.5	12.5	—	—	15.9	18 000	23 000	7906CDB	7906CDF	7906CDT	19.3	1.3	32.5	—	44.5	45.8	0.3	0.15	0.092
	55	26	1	0.6	14.2	9.75	—	—	7.9	21 000	32 000	HAR006CDB	HAR006CDF	HAR006CDT	24.4	1.6	35.5	—	49.5	50.5	1	0.6	0.232
	55	26	1	0.6	23.6	20.2	—	—	—	11 000	14 000	7006DB	7006DF	7006DT	37.5	11.5	35.5	—	49.5	50.5	1	0.6	0.266
	55	26	1	0.6	21.3	18.4	—	—	—	8 500	11 000	7006BDB	7006BDF	7006BDT	48.7	22.7	35.5	—	49.5	50.5	1	0.6	0.266
	55	26	1	0.6	25.7	22.0	—	—	14.9	16 000	21 000	7006CDB	7006CDF	7006CDT	24.4	1.6	35.5	—	49.5	50.5	1	0.6	0.266
	62	32	1	0.6	34.7	27.4	36.6	29.7	—	10 000	13 000	7206DB	7206DF	7206DT	43.0	11.0	35.5	34.5	56.5	57.5	1	0.6	0.416
	62	32	1	0.6	31.6	25.0	33.3	27.1	—	7 700	10 000	7206BDB	7206BDF	7206BDT	55.2	23.2	35.5	34.5	56.5	57.5	1	0.6	0.416
	62	32	1	0.6	37.4	29.5	39.5	32.0	14.0	14 000	19 000	7206CDB	7206CDF	7206CDT	28.5	3.5	35.5	34.5	56.5	57.5	1	0.6	0.416
	72	38	1.1	0.6	48.9	37.8	51.8	41.2	—	9 200	12 000	7306DB	7306DF	7306DT	49.0	11.0	37	34.5	65	67.5	1	0.6	0.724
	72	38	1.1	0.6	44.9	34.7	47.5	37.9	—	6 900	9 200	7306BDB	7306BDF	7306BDT	62.6	24.6	37	34.5	65	67.5	1	0.6	0.724
	72	38	1.1	0.6	52.5	40.5	55.6	44.2	13.4	13 000	17 000	7306CDB	7306CDF	7306CDT	32.9	5.1	37	34.5	65	67.5	1	0.6	0.724
	90	46	1.5	1	77.3	56.9	82.9	63.2	—	5 700	8 100	7406DB	7406DF	7406DT	58.5	12.5	38.5	35.5	81.5	84.5	1.5	1	1.37
	90	46	1.5	1	71.8	52.8	77.0	58.6	—	4 900	7 300	7406BDB	7406BDF	7406BDT	74.6	28.6	38.5	35.5	81.5	84.5	1.5	1	1.37
35	55	20	0.6	0.3	20.4	19.4	—	—	15.7	15 000	20 000	7907CDB	7907CDF	7907CDT	22.1	2.1	39.5	—	50.5	52.5	0.6	0.3	0.148
	62	28	1	0.6	15.0	11.1	—	—	8.1	18 000	28 000	HAR007CDB	HAR007CDF	HAR007CDT	27.0	1.0	40.5	—	56.5	57.5	1	0.6	0.316
	62	28	1	0.6	28.4	25.2	—	—	—	9 800	12 000	7007DB	7007DF	7007DT	42.3	14.3	40.5	—	56.5	57.5	1	0.6	0.340
	62	28	1	0.6	25.7	22.8	—	—	—	7 300	9 800	7007BDB	7007BDF	7007BDT	55.1	27.1	40.5	—	56.5	57.5	1	0.6	0.340
	62	28	1	0.6	31.0	27.4	—	—	15.0	13 000	18 000	7007CDB	7007CDF	7007CDT	27.0	1.0	40.5	—	56.5	57.5	1	0.6	0.340
	72	34	1.1	0.6	45.7	37.3	48.2	40.4	—	8 800	11 000	7207DB	7207DF	7207DT	48.5	14.5	42	39.5	65	67.5	1	0.6	0.590
	72	34	1.1	0.6	41.6	34.1	43.9	36.9	—	6 600	8 800	7207BDB	7207BDF	7207BDT	62.7	28.7	42	39.5	65	67.5	1	0.6	0.590
	72	34	1.1	0.6	49.4	40.2	52.1	43.5	14.0	12 000	16 000	7207CDB	7207CDF	7207CDT	31.6	2.4	42	39.5	65	67.5	1	0.6	0.590
	80	42	1.5	1	57.5	44.0	64.9	52.8	—	8 200	10 000	7307DB	7307DF	7307DT	54.8	12.8	43.5	40.5	71.5	74.5	1.5	1	0.950

[Notes] 1) Limiting speeds shown above are applicable to machined cage bearings. Limiting speeds of pressed cage bearings should be kept to under 80% of this value. For bearings with 15° contact angle, this figure is applied to the high precision bearings ranked higher than class 5, used with machined cages or molded cages.

2) B, C or no indication after the bearing number indicates nominal contact angle of 40°, 15° and 30° respectively. [Remark] Standard cage types used for the above bearings are described earlier in this section.

Angular contact ball bearings (matched pair)

d (35) ~ (45) mm

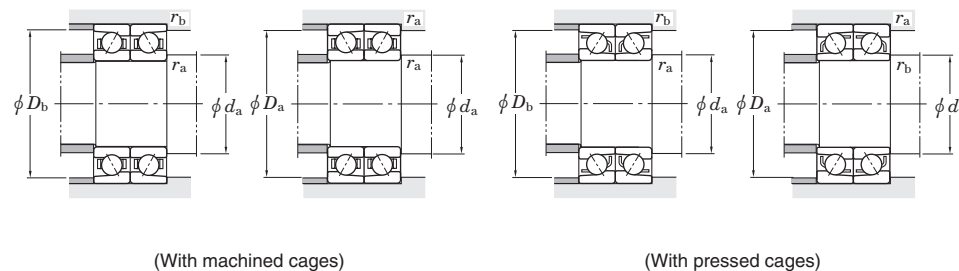
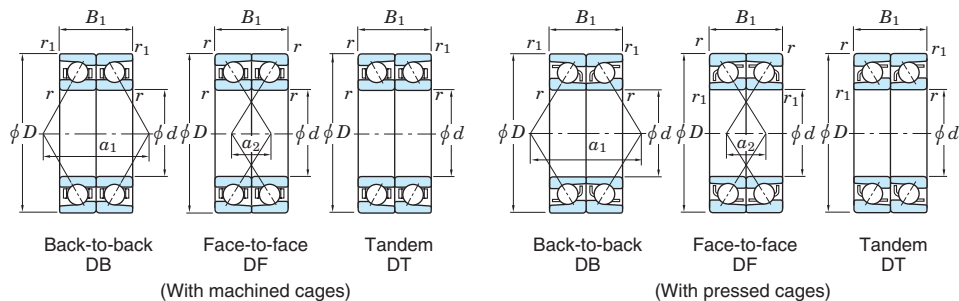

Boundary dimensions (mm)					Basic load ratings (kN)				Factor $f_0$	Limiting speeds <sup>1)</sup> (min <sup>-1</sup> )		Bearing No. <sup>2)</sup>			Load center spread (mm)		Mounting dimensions (mm)						(Refer.) Mass (kg)
$d$	$D$	$B_1$	$r_{min.}$	$r_{1min.}$	With machined cages		With pressed cages			Grease lub.	Oil lub.	Back-to-back DB	Face-to-face DF	Tandem DT	$a_1$	$a_2$	$d_a$ min.	$d_b$ min.	$D_a$ max.	$D_b$ max.	$r_a$ max.	$r_b$ max.	
35	80	42	1.5	1	52.7	40.5	59.5	48.6	—	6 200	8 200	7307BDB	7307BDF	7307BDT	70.1	28.1	43.5	40.5	71.5	74.5	1.5	1	0.950
	80	42	1.5	1	61.6	47.2	69.6	56.6	13.4	11 000	15 000	7307CDB	7307CDF	7307CDT	36.7	5.3	43.5	40.5	71.5	74.5	1.5	1	0.950
	100	50	1.5	1	98.2	73.9	105	82.1	—	5 000	7 200	7407DB	7407DF	7407DT	65.2	15.2	43.5	40.5	91.5	94.5	1.5	1	1.90
	100	50	1.5	1	91.3	68.6	97.9	76.2	—	4 300	6 500	7407BDB	7407BDF	7407BDT	83.3	33.3	43.5	40.5	91.5	94.5	1.5	1	1.90
40	62	24	0.6	0.3	25.6	24.9	—	—	15.7	13 000	18 000	7908CDB	7908CDF	7908CDT	25.7	1.7	44.5	—	57.5	59.5	0.6	0.3	0.214
	62	24	0.6	0.3	10.3	8.15	—	—	8.4	17 000	27 000	HAR908CDB	HAR908CDF	HAR908CDT	25.7	1.7	44.5	—	57.5	59.5	0.6	0.3	0.230
	68	30	1	0.6	15.8	12.4	—	—	8.2	16 000	25 000	HAR008CDB	HAR008CDF	HAR008CDT	29.5	0.5	45.5	—	62.5	63.5	1	0.6	0.400
	68	30	1	0.6	30.4	29.2	—	—	—	8 900	11 000	7008DB	7008DF	7008DT	46.3	16.3	45.5	—	62.5	63.5	1	0.6	0.420
	68	30	1	0.6	27.4	26.4	—	—	—	6 600	8 900	7008BDB	7008BDF	7008BDT	60.5	30.5	45.5	—	62.5	63.5	1	0.6	0.420
	68	30	1	0.6	33.4	31.8	—	—	15.4	12 000	16 000	7008CDB	7008CDF	7008CDT	29.5	0.5	45.5	—	62.5	63.5	1	0.6	0.420
	80	36	1.1	0.6	54.6	46.7	57.4	50.3	—	8 000	10 000	7208DB	7208DF	7208DT	52.7	16.7	47	44.5	73	75.5	1	0.6	0.764
	80	36	1.1	0.6	49.7	42.7	52.2	45.9	—	6 000	8 000	7208BDB	7208BDF	7208BDT	68.3	32.3	47	44.5	73	75.5	1	0.6	0.764
	80	36	1.1	0.6	59.1	50.4	62.0	54.3	14.2	11 000	15 000	7208CDB	7208CDF	7208CDT	34.1	1.9	47	44.5	73	75.5	1	0.6	0.764
	90	46	1.5	1	70.2	54.9	79.3	65.9	—	7 400	9 200	7308DB	7308DF	7308DT	60.5	14.5	48.5	45.5	81.5	84.5	1.5	1	1.31
	90	46	1.5	1	64.5	50.5	72.8	60.6	—	5 500	7 400	7308BDB	7308BDF	7308BDT	77.5	31.5	48.5	45.5	81.5	84.5	1.5	1	1.31
	90	46	1.5	1	75.3	58.8	85.0	70.5	13.4	10 000	14 000	7308CDB	7308CDF	7308CDT	40.4	5.6	48.5	45.5	81.5	84.5	1.5	1	1.31
110	54	2	1	114	87.1	122	96.8	—	4 600	6 600	7408DB	7408DF	7408DT	70.9	16.9	50	45.5	100	104.5	2	1	2.46	
110	54	2	1	105	80.8	113	89.8	—	3 900	5 900	7408BDB	7408BDF	7408BDT	90.8	36.8	50	45.5	100	104.5	2	1	2.46	
45	68	24	0.6	0.3	27.0	28.2	—	—	16.0	12 000	16 000	7909CDB	7909CDF	7909CDT	27.1	3.1	49.5	—	63.5	65.5	0.6	0.3	0.254
	68	24	0.6	0.3	11.0	9.35	—	—	8.5	16 000	24 000	HAR909CDB	HAR909CDF	HAR909CDT	27.1	3.1	49.5	—	63.5	65.5	0.6	0.3	0.272
	75	32	1	0.6	17.6	14.2	—	—	8.3	15 000	23 000	HAR009CDB	HAR009CDF	HAR009CDT	32.1	0.1	50.5	—	69.5	70.5	1	0.6	0.502
	75	32	1	0.6	36.2	35.4	—	—	—	8 000	10 000	7009DB	7009DF	7009DT	50.7	18.7	50.5	—	69.5	70.5	1	0.6	0.520
	75	32	1	0.6	32.5	32.0	—	—	—	6 000	8 000	7009BDB	7009BDF	7009BDT	66.3	34.3	50.5	—	69.5	70.5	1	0.6	0.520
	75	32	1	0.6	39.6	38.5	—	—	15.4	11 000	15 000	7009CDB	7009CDF	7009CDT	32.1	0.1	50.5	—	69.5	70.5	1	0.6	0.520
	85	38	1.1	0.6	61.3	53.2	64.4	57.2	—	7 500	9 400	7209DB	7209DF	7209DT	56.0	18.0	52	49.5	78	80.5	1	0.6	0.860
	85	38	1.1	0.6	55.8	48.6	58.6	52.3	—	5 600	7 500	7209BDB	7209BDF	7209BDT	72.8	34.8	52	49.5	78	80.5	1	0.6	0.860
	85	38	1.1	0.6	66.3	57.4	69.7	61.8	14.2	10 000	14 000	7209CDB	7209CDF	7209CDT	36.2	1.8	52	49.5	78	80.5	1	0.6	0.860

[Notes] 1) Limiting speeds shown above are applicable to machined cage bearings. Limiting speeds of pressed cage bearings should be kept to under 80% of this value. For bearings with 15° contact angle, this figure is applied to the high precision bearings ranked higher than class 5, used with machined cages or molded cages.

2) B, C or no indication after the bearing number indicates nominal contact angle of 40°, 15° and 30° respectively. [Remark] Standard cage types used for the above bearings are described earlier in this section.

# Angular contact ball bearings (matched pair)

$d$  (45) ~ (55) mm

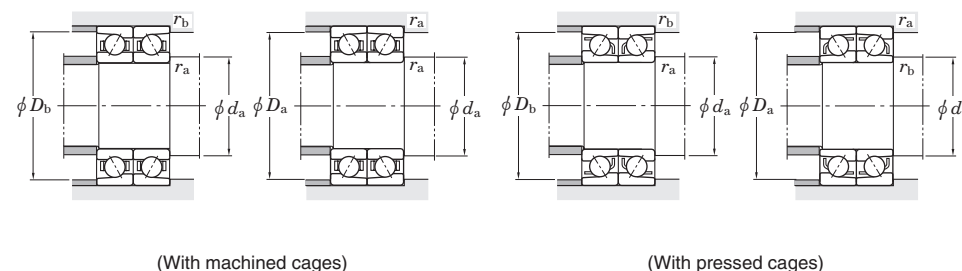
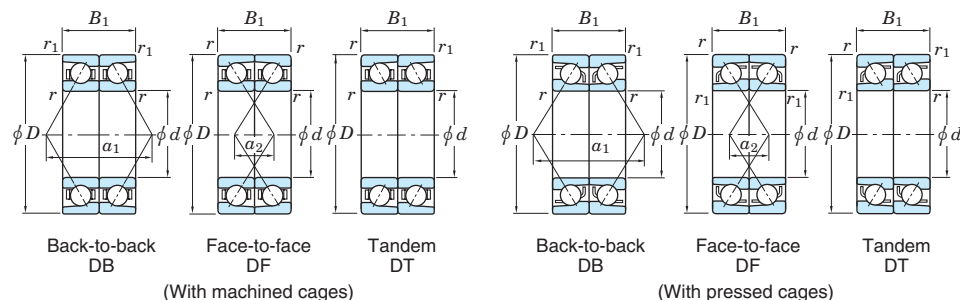

Boundary dimensions (mm)					Basic load ratings (kN)				Factor $f_0$	Limiting speeds <sup>1)</sup> (min <sup>-1</sup> )		Bearing No. <sup>2)</sup>			Load center spread (mm)		Mounting dimensions (mm)						(Refer.) Mass (kg)
$d$	$D$	$B_1$	$r_{min.}$	$r_{1min.}$	With machined cages		With pressed cages			Grease lub.	Oil lub.	Back-to-back DB	Face-to-face DF	Tandem DT	$a_1$	$a_2$	$d_a$ min.	$d_b$ min.	$D_a$ max.	$D_b$ max.	$r_a$ max.	$r_b$ max.	
45	100	50	1.5	1	89.6	74.2	94.9	80.9	—	6 600	8 200	7309DB	7309DF	7309DT	67.2	17.2	53.5	50.5	91.5	94.5	1.5	1	1.75
	100	50	1.5	1	82.1	68.2	87.1	74.3	—	4 900	6 600	7309BDB	7309BDF	7309BDT	86.3	36.3	53.5	50.5	91.5	94.5	1.5	1	1.75
	100	50	1.5	1	96.1	79.5	102	86.7	13.5	9 000	12 000	7309CDB	7309CDF	7309CDT	44.6	5.4	53.5	50.5	91.5	94.5	1.5	1	1.75
	120	58	2	1	138	108	148	120	—	4 200	6 000	7409DB	7409DF	7409DT	77.2	19.2	55	50.5	110	114.5	2	1	3.10
	120	58	2	1	128	100	138	111	—	3 600	5 400	7409BDB	7409BDF	7409BDT	99.1	41.1	55	50.5	110	114.5	2	1	3.10
50	72	24	0.6	0.3	28.3	31.4	—	—	16.2	11 000	15 000	7910CDB	7910CDF	7910CDT	28.3	4.3	54.5	—	67.5	69.5	0.6	0.3	0.256
	72	24	0.6	0.3	14.8	12.6	—	—	8.5	14 000	22 000	HAR910CDB	HAR910CDF	HAR910CDT	28.3	4.3	54.5	—	67.5	69.5	0.6	0.3	0.262
	80	32	1	0.6	18.5	15.7	—	—	8.4	14 000	21 000	HAR010CDB	HAR010CDF	HAR010CDT	33.4	1.4	55.5	—	74.5	75.5	1	0.6	0.546
	80	32	1	0.6	38.4	40.2	—	—	—	7 300	9 200	7010DB	7010DF	7010DT	53.8	21.8	55.5	—	74.5	75.5	1	0.6	0.580
	80	32	1	0.6	34.5	36.2	—	—	—	5 500	7 400	7010BDB	7010BDF	7010BDT	70.5	38.5	55.5	—	74.5	75.5	1	0.6	0.580
	80	32	1	0.6	42.2	43.9	—	—	15.7	10 000	13 000	7010CDB	7010CDF	7010CDT	33.6	1.6	55.5	—	74.5	75.5	1	0.6	0.580
	90	40	1.1	0.6	64.0	58.7	67.0	62.9	—	6 800	8 500	7210DB	7210DF	7210DT	60.7	20.7	57	54.5	83	85.5	1	0.6	0.970
	90	40	1.1	0.6	58.0	53.5	60.7	57.3	—	5 100	6 800	7210BDB	7210BDF	7210BDT	79.2	39.2	57	54.5	83	85.5	1	0.6	0.970
	90	40	1.1	0.6	69.6	63.6	72.8	68.1	14.6	9 400	12 000	7210CDB	7210CDF	7210CDT	38.9	1.1	57	54.5	83	85.5	1	0.6	0.970
	110	54	2	1	114	96.3	121	105	—	5 800	7 300	7310DB	7310DF	7310DT	74.4	20.4	60	55.5	100	104.5	2	1	2.28
	110	54	2	1	105	88.6	111	96.6	—	4 400	5 800	7310BDB	7310BDF	7310BDT	95.8	41.8	60	55.5	100	104.5	2	1	2.28
	110	54	2	1	122	103	129	112	13.4	8 000	11 000	7310CDB	7310CDF	7310CDT	49.0	5.0	60	55.5	100	104.5	2	1	2.28
	130	62	2.1	1.1	158	131	—	—	—	3 800	5 500	7410DB	7410DF	7410DT	83.3	21.3	62	—	118	123	2	1	3.84
130	62	2.1	1.1	147	121	—	—	—	3 300	4 900	7410BDB	7410BDF	7410BDT	106.9	44.9	62	—	118	123	2	1	3.84	
55	80	26	1	0.6	32.0	37.0	—	—	16.3	10 000	14 000	7911CDB	7911CDF	7911CDT	31.1	5.1	60.5	—	74.5	75.5	1	0.6	0.356
	80	26	1	0.6	16.4	15.3	—	—	8.6	13 000	20 000	HAR911CDB	HAR911CDF	HAR911CDT	31.1	5.1	60.5	—	74.5	75.5	1	0.6	0.378
	90	36	1.1	0.6	22.9	19.8	—	—	8.4	12 000	19 000	HAR011CDB	HAR011CDF	HAR011CDT	37.4	1.4	62	—	83	85.5	1	0.6	0.806
	90	36	1.1	0.6	50.5	52.5	—	—	—	6 600	8 300	7011DB	7011DF	7011DT	59.9	23.9	62	—	83	85.5	1	0.6	0.840
	90	36	1.1	0.6	45.4	47.5	—	—	—	5 000	6 600	7011BDB	7011BDF	7011BDT	78.8	42.8	62	—	83	85.5	1	0.6	0.840
	90	36	1.1	0.6	55.4	57.3	—	—	15.5	9 100	12 000	7011CDB	7011CDF	7011CDT	37.4	1.4	62	—	83	85.5	1	0.6	0.840
	100	42	1.5	1	79.1	74.2	82.8	79.6	—	6 100	7 600	7211DB	7211DF	7211DT	66.6	24.6	63.5	60.5	91.5	94.5	1.5	1	1.27
	100	42	1.5	1	71.6	67.6	75.0	72.4	—	4 600	6 100	7211BDB	7211BDF	7211BDT	87.3	45.3	63.5	60.5	91.5	94.5	1.5	1	1.27

[Notes] 1) Limiting speeds shown above are applicable to machined cage bearings. Limiting speeds of pressed cage bearings should be kept to under 80% of this value. For bearings with 15° contact angle, this figure is applied to the high precision bearings ranked higher than class 5, used with machined cages or molded cages.

2) B, C or no indication after the bearing number indicates nominal contact angle of 40°, 15° and 30° respectively. [Remark] Standard cage types used for the above bearings are described earlier in this section.

Angular contact ball bearings (matched pair)

d (55) ~ (65) mm

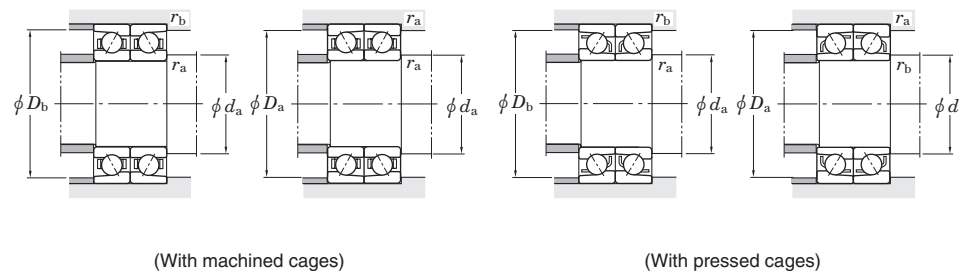
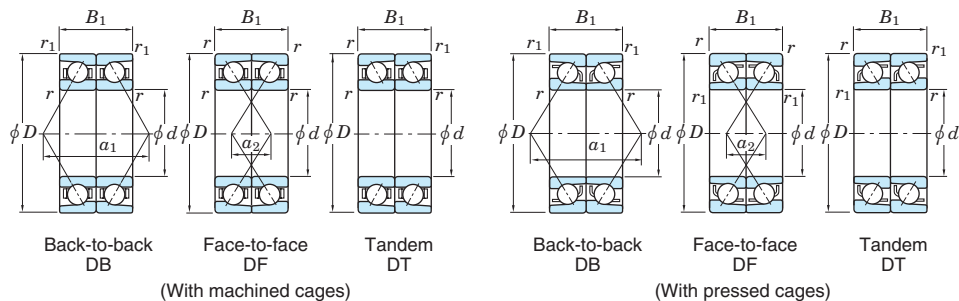

Boundary dimensions (mm)					Basic load ratings (kN)				Factor $f_0$	Limiting speeds <sup>1)</sup> (min <sup>-1</sup> )		Bearing No. <sup>2)</sup>			Load center spread (mm)		Mounting dimensions (mm)						(Refer.) Mass (kg)
$d$	$D$	$B_1$	$r_{min.}$	$r_{1min.}$	With machined cages		With pressed cages			Grease lub.	Oil lub.	Back-to-back DB	Face-to-face DF	Tandem DT	$a_1$	$a_2$	$d_a$ min.	$d_b$ min.	$D_a$ max.	$D_b$ max.	$r_a$ max.	$r_b$ max.	
55	100	42	1.5	1	85.9	80.4	90.0	86.1	14.6	8 400	11 000	7211CDB	7211CDF	7211CDT	42.2	0.2	63.5	60.5	91.5	94.5	1.5	1	1.27
	120	58	2	1	132	113	139	123	—	5 400	6 700	7311DB	7311DF	7311DT	80.4	22.4	65	60.5	110	114.5	2	1	2.90
	120	58	2	1	121	104	128	113	—	4 000	5 400	7311BDB	7311BDF	7311BDT	103.7	45.7	65	60.5	110	114.5	2	1	2.90
	120	58	2	1	141	121	149	132	13.4	7 400	9 800	7311CDB	7311CDF	7311CDT	52.9	5.1	65	60.5	110	114.5	2	1	2.90
	140	66	2.1	1.1	192	165	—	—	—	3 500	5 000	7411DB	7411DF	7411DT	89.9	23.9	67	—	128	133	2	1	4.72
	140	66	2.1	1.1	179	153	—	—	—	3 000	4 500	7411BDB	7411BDF	7411BDT	115.7	49.7	67	—	128	133	2	1	4.72
60	85	26	1	0.6	37.8	43.6	—	—	16.3	9 100	13 000	7912CDB	7912CDF	7912CDT	32.6	6.6	65.5	—	79.5	80.5	1	0.6	0.374
	85	26	1	0.6	16.2	15.5	—	—	8.6	12 000	19 000	HAR912CDB	HAR912CDF	HAR912CDT	32.4	6.4	65.5	—	79.5	80.5	1	0.6	0.404
	95	36	1.1	0.6	23.9	21.7	—	—	8.5	11 000	18 000	HAR012CDB	HAR012CDF	HAR012CDT	38.8	2.8	67	—	88	90.5	1	0.6	0.866
	95	36	1.1	0.6	51.8	56.1	—	—	—	6 200	7 700	7012DB	7012DF	7012DT	62.8	26.8	67	—	88	90.5	1	0.6	0.900
	95	36	1.1	0.6	46.4	50.7	—	—	—	4 600	6 200	7012BDB	7012BDF	7012BDT	83.0	47.0	67	—	88	90.5	1	0.6	0.900
	95	36	1.1	0.6	56.9	61.3	—	—	15.7	8 500	11 000	7012CDB	7012CDF	7012CDT	38.8	2.8	67	—	88	90.5	1	0.6	0.900
	110	44	1.5	1	95.7	91.5	100	98.0	—	5 500	6 900	7212DB	7212DF	7212DT	72.3	28.3	68.5	65.5	101.5	104.5	1.5	1	1.64
	110	44	1.5	1	86.8	83.3	90.8	89.2	—	4 100	5 500	7212BDB	7212BDF	7212BDT	95.0	51.0	68.5	65.5	101.5	104.5	1.5	1	1.64
	110	44	1.5	1	104	99.0	109	106	14.5	7 500	10 000	7212CDB	7212CDF	7212CDT	45.3	1.3	68.5	65.5	101.5	104.5	1.5	1	1.64
	130	62	2.1	1.1	150	131	159	143	—	5 000	6 200	7312DB	7312DF	7312DT	86.5	24.5	72	67	118	123	2	1	3.62
	130	62	2.1	1.1	138	121	146	132	—	3 700	5 000	7312BDB	7312BDF	7312BDT	111.6	49.6	72	67	118	123	2	1	3.62
	130	62	2.1	1.1	161	141	171	153	13.4	6 800	9 100	7312CDB	7312CDF	7312CDT	56.7	5.3	72	67	118	123	2	1	3.62
150	70	2.1	1.1	209	187	—	—	—	3 200	4 600	7412DB	7412DF	7412DT	97.0	27.0	72	—	138	143	2	1	5.70	
150	70	2.1	1.1	194	173	—	—	—	2 800	4 100	7412BDB	7412BDF	7412BDT	125.1	55.1	72	—	138	143	2	1	5.70	
65	90	26	1	0.6	33.7	42.3	—	—	16.5	8 600	12 000	7913CDB	7913CDF	7913CDT	33.8	7.8	70.5	—	84.5	85.5	1	0.6	0.410
	90	26	1	0.6	19.1	18.9	—	—	8.6	11 000	18 000	HAR913CDB	HAR913CDF	HAR913CDT	33.8	7.8	70.5	—	84.5	85.5	1	0.6	0.424
	100	36	1.1	0.6	24.8	23.5	—	—	8.5	11 000	16 000	HAR013CDB	HAR013CDF	HAR013CDT	40.1	4.1	72	—	93	95.5	1	0.6	0.924
	100	36	1.1	0.6	54.7	62.8	—	—	—	5 800	7 200	7013DB	7013DF	7013DT	65.9	29.9	72	—	93	95.5	1	0.6	0.940
	100	36	1.1	0.6	48.9	56.6	—	—	—	4 300	5 800	7013BDB	7013BDF	7013BDT	87.6	51.6	72	—	93	95.5	1	0.6	0.940
	100	36	1.1	0.6	60.2	68.7	—	—	15.9	7 900	11 000	7013CDB	7013CDF	7013CDT	40.2	4.2	72	—	93	95.5	1	0.6	0.940
	120	46	1.5	1	109	108	114	116	—	5 200	6 400	7213DB	7213DF	7213DT	76.4	30.4	73.5	70.5	111.5	114.5	1.5	1	2.04

[Notes] 1) Limiting speeds shown above are applicable to machined cage bearings. Limiting speeds of pressed cage bearings should be kept to under 80% of this value. For bearings with 15° contact angle, this figure is applied to the high precision bearings ranked higher than class 5, used with machined cages or molded cages.

2) B, C or no indication after the bearing number indicates nominal contact angle of 40°, 15° and 30° respectively. [Remark] Standard cage types used for the above bearings are described earlier in this section.



Angular contact ball bearings (matched pair)

d (65) ~ (75) mm

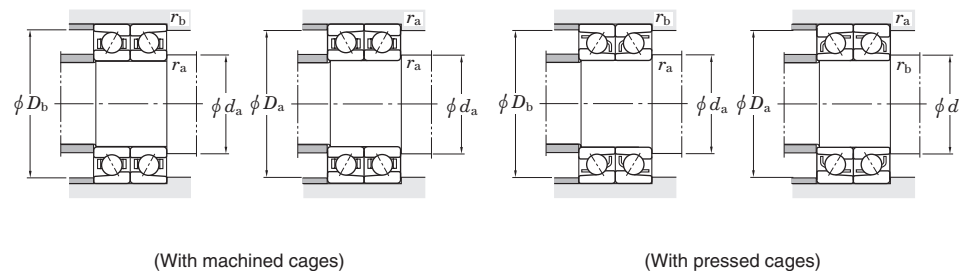
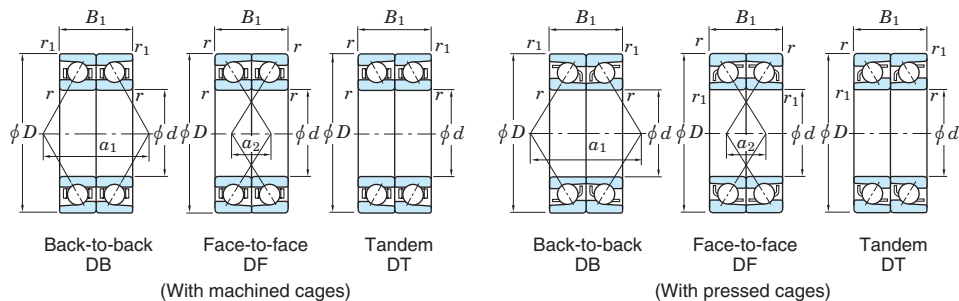

Boundary dimensions (mm)					Basic load ratings (kN)				Factor	Limiting speeds <sup>1)</sup> (min <sup>-1</sup> )		Bearing No. <sup>2)</sup>			Load center spread (mm)		Mounting dimensions (mm)						(Refer.) Mass (kg)
d	D	B <sub>1</sub>	r <sub>min.</sub>	r <sub>1 min.</sub>	With machined cages		With pressed cages			Grease lub.	Oil lub.	Back-to-back DB	Face-to-face DF	Tandem DT	a <sub>1</sub>	a <sub>2</sub>	d <sub>a min.</sub>	d <sub>b min.</sub>	D <sub>a max.</sub>	D <sub>b max.</sub>	r <sub>a max.</sub>	r <sub>b max.</sub>	
65	120	46	1.5	1	99.0	98.7	103	105	—	3 900	5 200	7213BDB	7213BDF	7213BDT	100.6	54.6	73.5	70.5	111.5	114.5	1.5	1	2.04
	120	46	1.5	1	119	117	124	125	14.6	7 100	9 400	7213CDB	7213CDF	7213CDT	47.8	1.8	73.5	70.5	111.5	114.5	1.5	1	2.04
	140	66	2.1	1.1	170	151	180	164	—	4 600	5 800	7313DB	7313DF	7313DT	92.5	26.5	77	72	128	133	2	1	4.44
	140	66	2.1	1.1	156	139	165	151	—	3 500	4 600	7313BDB	7313BDF	7313BDT	119.4	53.4	77	72	128	133	2	1	4.44
	140	66	2.1	1.1	182	161	193	176	13.4	6 300	8 500	7313CDB	7313CDF	7313CDT	60.6	5.4	77	72	128	133	2	1	4.44
	160	74	2.1	1.1	226	209	—	—	—	3 000	4 300	7413DB	7413DF	7413DT	102.9	28.9	77	—	148	153	2	1	6.82
	160	74	2.1	1.1	209	194	—	—	—	2 600	3 900	7413BDB	7413BDF	7413BDT	132.7	58.7	77	—	148	153	2	1	6.82
70	100	32	1	0.6	47.0	58.0	—	—	16.4	7 800	11 000	7914CDB	7914CDF	7914CDT	38.8	6.8	75.5	—	94.5	95.5	1	0.6	0.664
	100	32	1	0.6	20.9	20.9	—	—	8.7	10 000	16 000	HAR914CDB	HAR914CDF	HAR914CDT	38.8	6.8	75.5	—	94.5	95.5	1	0.6	0.712
	110	40	1.1	0.6	33.7	30.9	—	—	8.4	9 800	15 000	HAR014CDB	HAR014CDF	HAR014CDT	44.1	4.1	77	—	103	105.5	1	0.6	1.26
	110	40	1.1	0.6	69.3	78.7	—	—	—	5 300	6 600	7014DB	7014DF	7014DT	72.0	32.0	77	—	103	105.5	1	0.6	1.32
	110	40	1.1	0.6	62.1	71.1	—	—	—	4 000	5 300	7014BDB	7014BDF	7014BDT	95.5	55.5	77	—	103	105.5	1	0.6	1.32
	110	40	1.1	0.6	76.2	86.0	—	—	15.7	7 300	9 700	7014CDB	7014CDF	7014CDT	44.1	4.1	77	—	103	105.5	1	0.6	1.32
	125	48	1.5	1	113	111	124	127	—	4 900	6 100	7214DB	7214DF	7214DT	80.3	32.3	78.5	75.5	116.5	119.5	1.5	1	2.24
	125	48	1.5	1	103	101	112	116	—	3 700	4 900	7214BDB	7214BDF	7214BDT	105.8	57.8	78.5	75.5	116.5	119.5	1.5	1	2.24
	125	48	1.5	1	123	120	135	138	14.6	6 700	8 900	7214CDB	7214CDF	7214CDT	50.1	2.1	78.5	75.5	116.5	119.5	1.5	1	2.24
	150	70	2.1	1.1	191	172	203	187	—	4 300	5 400	7314DB	7314DF	7314DT	98.5	28.5	82	77	138	143	2	1	5.40
	150	70	2.1	1.1	175	158	186	172	—	3 200	4 300	7314BDB	7314BDF	7314BDT	127.3	57.3	82	77	138	143	2	1	5.40
	150	70	2.1	1.1	205	184	217	200	13.4	5 900	7 900	7314CDB	7314CDF	7314CDT	64.5	5.5	82	77	138	143	2	1	5.40
	180	84	3	1.1	242	230	—	—	—	2 700	3 900	7414DB	7414DF	7414DT	115.3	31.3	84	—	166	173	2.5	1	9.98
	180	84	3	1.1	241	237	—	—	—	2 300	3 500	7414BDB	7414BDF	7414BDT	148.4	64.4	84	—	166	173	2.5	1	9.98
75	105	32	1	0.6	47.7	60.9	—	—	16.5	7 400	9 800	7915CDB	7915CDF	7915CDT	40.1	8.1	80.5	—	99.5	100.5	1	0.6	0.700
	105	32	1	0.6	21.5	22.4	—	—	8.7	9 800	15 000	HAR915CDB	HAR915CDF	HAR915CDT	40.1	8.1	80.5	—	99.5	100.5	1	0.6	0.740
	115	40	1.1	0.6	34.3	32.4	—	—	8.5	9 300	14 000	HAR015CDB	HAR015CDF	HAR015CDT	45.5	5.5	82	—	108	110.5	1	0.6	1.33
	115	40	1.1	0.6	70.9	83.4	—	—	—	5 000	6 300	7015DB	7015DF	7015DT	74.9	34.9	82	—	108	110.5	1	0.6	1.38
	115	40	1.1	0.6	63.5	75.2	—	—	—	3 800	5 000	7015BDB	7015BDF	7015BDT	99.7	59.7	82	—	108	110.5	1	0.6	1.38
	115	40	1.1	0.6	78.0	91.3	—	—	15.9	6 900	9 200	7015CDB	7015CDF	7015CDT	45.5	5.5	82	—	108	110.5	1	0.6	1.38

[Notes] 1) Limiting speeds shown above are applicable to machined cage bearings. Limiting speeds of pressed cage bearings should be kept to under 80% of this value. For bearings with 15° contact angle, this figure is applied to the high precision bearings ranked higher than class 5, used with machined cages or molded cages.

2) B, C or no indication after the bearing number indicates nominal contact angle of 40°, 15° and 30° respectively. [Remark] Standard cage types used for the above bearings are described earlier in this section.



Angular contact ball bearings (matched pair)

d (75) ~ (85) mm

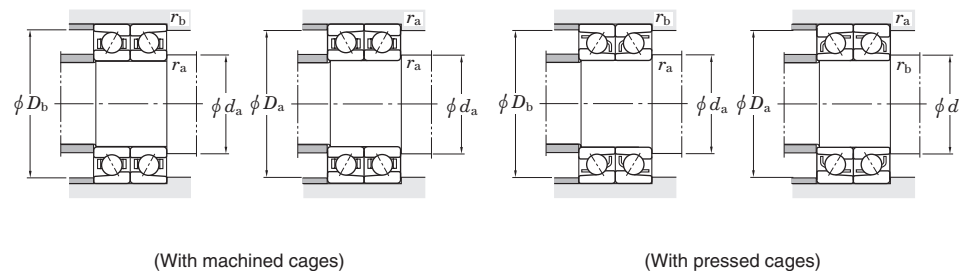
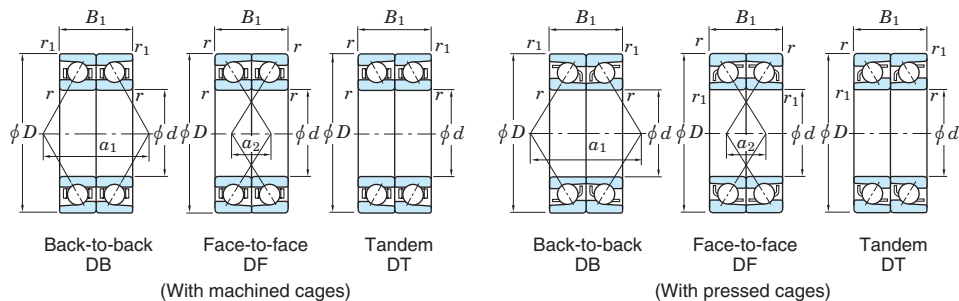

Boundary dimensions (mm)					Basic load ratings (kN)				Factor	Limiting speeds <sup>1)</sup> (min <sup>-1</sup> )		Bearing No. <sup>2)</sup>			Load center spread (mm)		Mounting dimensions (mm)						(Refer.) Mass (kg)
d	D	B <sub>1</sub>	r <sub>min.</sub>	r <sub>1 min.</sub>	With machined cages		With pressed cages			Grease lub.	Oil lub.	Back-to-back DB	Face-to-face DF	Tandem DT	α <sub>1</sub>	α <sub>2</sub>	d <sub>a min.</sub>	d <sub>b min.</sub>	D <sub>a max.</sub>	D <sub>b max.</sub>	r <sub>a max.</sub>	r <sub>b max.</sub>	
75	130	50	1.5	1	129	130	134	139	—	4 600	5 800	7215DB	7215DF	7215DT	84.2	34.2	83.5	80.5	121.5	124.5	1.5	1	2.46
	130	50	1.5	1	116	119	122	127	—	3 500	4 600	7215BDB	7215BDF	7215BDT	111.0	61.0	83.5	80.5	121.5	124.5	1.5	1	2.46
	130	50	1.5	1	140	141	146	151	14.6	6 400	8 500	7215CDB	7215CDF	7215CDT	52.5	2.5	83.5	80.5	121.5	124.5	1.5	1	2.46
	160	74	2.1	1.1	208	194	221	212	—	4 000	5 000	7315DB	7315DF	7315DT	104.9	30.9	87	82	148	153	2	1	6.30
	160	74	2.1	1.1	191	178	202	195	—	3 000	4 000	7315BDB	7315BDF	7315BDT	135.6	61.6	87	82	148	153	2	1	6.30
	160	74	2.1	1.1	223	208	236	227	13.4	5 500	7 400	7315CDB	7315CDF	7315CDT	68.5	5.5	87	82	148	153	2	1	6.30
	190	90	3	1.1	278	282	—	—	—	2 500	3 600	7415DB	7415DF	7415DT	122.7	32.7	89	—	176	183	2.5	1	11.8
190	90	3	1.1	257	261	—	—	—	2 200	3 300	7415BDB	7415BDF	7415BDT	157.9	67.9	89	—	176	183	2.5	1	11.8	
80	110	32	1	0.6	48.4	63.2	—	—	16.5	7 000	9 300	7916CDB	7916CDF	7916CDT	41.5	9.5	85.5	—	104.5	105.5	1	0.6	0.736
	110	32	1	0.6	22.2	23.9	—	—	8.8	9 300	14 000	HAR916CDB	HAR916CDF	HAR916CDT	41.5	9.5	85.5	—	104.5	105.5	1	0.6	0.796
	125	44	1.1	0.6	40.1	38.5	—	—	8.4	8 200	13 000	HAR016CDB	HAR016CDF	HAR016CDT	49.5	5.5	87	—	118	120.5	1	0.6	1.81
	125	44	1.1	0.6	86.7	101	—	—	—	4 600	5 800	7016DB	7016DF	7016DT	81.2	37.2	87	—	118	120.5	1	0.6	1.86
	125	44	1.1	0.6	77.7	91.3	—	—	—	3 500	4 600	7016BDB	7016BDF	7016BDT	108.0	64.0	87	—	118	120.5	1	0.6	1.86
	125	44	1.1	0.6	95.3	111	—	—	15.7	6 400	8 500	7016CDB	7016CDF	7016CDT	49.5	5.5	87	—	118	120.5	1	0.6	1.86
	140	52	2	1	139	143	145	152	—	4 300	5 400	7216DB	7216DF	7216DT	89.5	37.5	90	85.5	130	134.5	2	1	3.00
	140	52	2	1	125	130	131	139	—	3 200	4 300	7216BDB	7216BDF	7216BDT	118.3	66.3	90	85.5	130	134.5	2	1	3.00
	140	52	2	1	151	155	157	165	14.7	5 900	7 900	7216CDB	7216CDF	7216CDT	55.5	3.5	90	85.5	130	134.5	2	1	3.00
	170	78	2.1	1.1	226	218	239	238	—	3 800	4 700	7316DB	7316DF	7316DT	111.2	33.2	92	87	158	163	2	1	7.70
	170	78	2.1	1.1	207	200	219	218	—	2 800	3 800	7316BDB	7316BDF	7316BDT	143.9	65.9	92	87	158	163	2	1	7.70
	170	78	2.1	1.1	242	233	256	255	13.5	5 200	6 900	7316CDB	7316CDF	7316CDT	72.5	5.5	92	87	158	163	2	1	7.70
	200	96	3	1.1	313	332	—	—	—	2 400	3 400	7416DB	7416DF	7416DT	130.0	34.0	94	—	186	193	2.5	1	12.0
	200	96	3	1.1	290	307	—	—	—	2 100	3 100	7416BDB	7416BDF	7416BDT	167.2	71.2	94	—	186	193	2.5	1	12.0
85	120	36	1.1	0.6	63.2	81.3	—	—	16.5	6 500	8 600	7917CDB	7917CDF	7917CDT	45.5	9.5	92	—	113	115.5	1	0.6	1.05
	120	36	1.1	0.6	26.6	28.4	—	—	8.7	8 200	13 000	HAR917CDB	HAR917CDF	HAR917CDT	45.5	9.5	92	—	113	115.5	1	0.6	1.14
	130	44	1.1	0.6	40.8	40.2	—	—	8.5	7 800	12 000	HAR017CDB	HAR017CDF	HAR017CDT	50.8	6.8	92	—	123	125.5	1	0.6	1.89
	130	44	1.1	0.6	88.6	107	—	—	—	4 400	5 500	7017DB	7017DF	7017DT	84.7	40.7	92	—	123	125.5	1	0.6	1.94
	130	44	1.1	0.6	79.3	96.7	—	—	—	3 300	4 400	7017BDB	7017BDF	7017BDT	113.0	69.0	92	—	123	125.5	1	0.6	1.94

[Notes] 1) Limiting speeds shown above are applicable to machined cage bearings. Limiting speeds of pressed cage bearings should be kept to under 80% of this value. For bearings with 15° contact angle, this figure is applied to the high precision bearings ranked higher than class 5, used with machined cages or molded cages.

2) B, C or no indication after the bearing number indicates nominal contact angle of 40°, 15° and 30° respectively. [Remark] Standard cage types used for the above bearings are described earlier in this section.

Angular contact ball bearings (matched pair)

d (85) ~ (95) mm

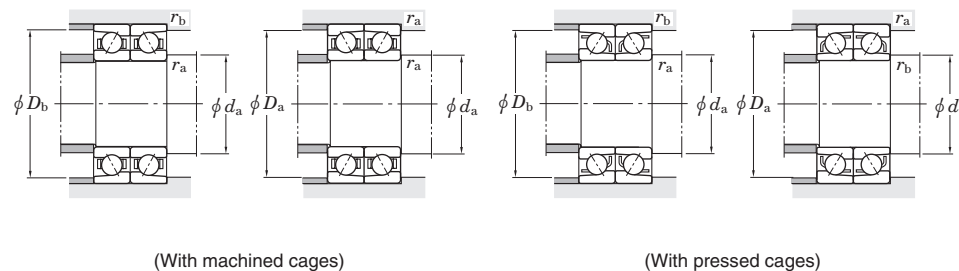
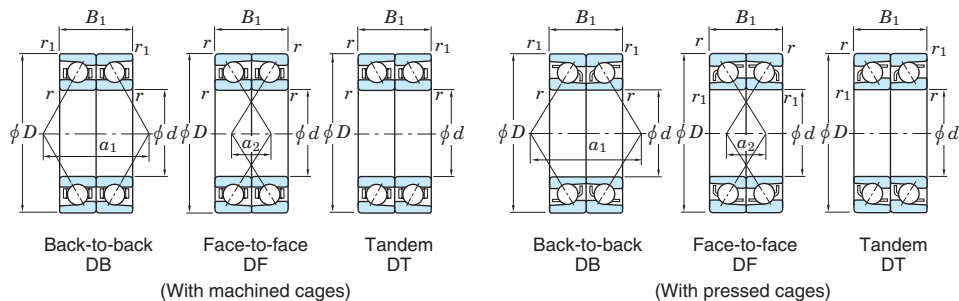

Boundary dimensions (mm)					Basic load ratings (kN)				Factor	Limiting speeds <sup>1)</sup> (min <sup>-1</sup> )		Bearing No. <sup>2)</sup>			Load center spread (mm)		Mounting dimensions (mm)						(Refer.) Mass (kg)
d	D	B <sub>1</sub>	r <sub>min.</sub>	r <sub>1 min.</sub>	With machined cages		With pressed cages			Grease lub.	Oil lub.	Back-to-back DB	Face-to-face DF	Tandem DT	a <sub>1</sub>	a <sub>2</sub>	d <sub>a min.</sub>	d <sub>b min.</sub>	D <sub>a max.</sub>	D <sub>b max.</sub>	r <sub>a max.</sub>	r <sub>b max.</sub>	
85	130	44	1.1	0.6	97.6	117	—	—	15.9	6 000	8 000	<b>7017CDB</b>	<b>7017CDF</b>	<b>7017CDT</b>	51.1	7.1	92	—	123	125.5	1	0.6	1.94
	150	56	2	1	160	167	167	178	—	4 000	5 000	<b>7217DB</b>	<b>7217DF</b>	<b>7217DT</b>	95.9	39.9	95	90.5	140	144.5	2	1	3.74
	150	56	2	1	145	152	151	162	—	3 000	4 000	<b>7217BDB</b>	<b>7217BDF</b>	<b>7217BDT</b>	126.6	70.6	95	90.5	140	144.5	2	1	3.74
	150	56	2	1	174	181	182	193	14.7	5 500	7 400	<b>7217CDB</b>	<b>7217CDF</b>	<b>7217CDT</b>	59.5	3.5	95	90.5	140	144.5	2	1	3.74
	180	82	3	1.1	243	243	258	265	—	3 500	4 400	<b>7317DB</b>	<b>7317DF</b>	<b>7317DT</b>	117.5	35.5	99	92	166	173	2.5	1	9.06
	180	82	3	1.1	223	223	236	244	—	2 700	3 500	<b>7317BDB</b>	<b>7317BDF</b>	<b>7317BDT</b>	152.2	70.2	99	92	166	173	2.5	1	9.06
	180	82	3	1.1	261	261	277	284	13.5	4 900	6 500	<b>7317CDB</b>	<b>7317CDF</b>	<b>7317CDT</b>	76.5	5.5	99	92	166	173	2.5	1	9.06
	210	104	4	1.5	331	360	—	—	—	2 300	3 300	<b>7417DB</b>	<b>7417DF</b>	<b>7417DT</b>	137.5	33.5	103	—	192	201.5	3	1.5	17.1
	210	104	4	1.5	307	334	—	—	—	2 000	3 000	<b>7417BDB</b>	<b>7417BDF</b>	<b>7417BDT</b>	176.2	72.2	103	—	192	201.5	3	1.5	17.1
	90	125	36	1.1	0.6	64.3	85.2	—	—	16.6	6 200	8 200	<b>7918CDB</b>	<b>7918CDF</b>	<b>7918CDT</b>	46.8	10.8	97	—	118	120.5	1	0.6
125		36	1.1	0.6	27.3	30.2	—	—	8.8	7 800	12 000	<b>HAR918CDB</b>	<b>HAR918CDF</b>	<b>HAR918CDT</b>	46.8	10.8	97	—	118	120.5	1	0.6	1.20
140		48	1.5	1	53.3	52.1	—	—	8.4	7 300	11 000	<b>HAR018CDB</b>	<b>HAR018CDF</b>	<b>HAR018CDT</b>	54.8	6.8	98.5	—	131.5	134.5	1.5	1	2.43
140		48	1.5	1	106	127	—	—	—	4 100	5 100	<b>7018DB</b>	<b>7018DF</b>	<b>7018DT</b>	90.4	42.4	98.5	—	131.5	134.5	1.5	1	2.52
140		48	1.5	1	94.9	114	—	—	—	3 100	4 100	<b>7018BDB</b>	<b>7018BDF</b>	<b>7018BDT</b>	120.5	72.5	98.5	—	131.5	134.5	1.5	1	2.52
140		48	1.5	1	116	138	—	—	15.7	5 700	7 500	<b>7018CDB</b>	<b>7018CDF</b>	<b>7018CDT</b>	54.8	6.8	98.5	—	131.5	134.5	1.5	1	2.52
160		60	2	1	183	193	191	206	—	3 800	4 700	<b>7218DB</b>	<b>7218DF</b>	<b>7218DT</b>	102.2	42.2	100	95.5	150	154.5	2	1	4.60
160		60	2	1	166	176	173	188	—	2 800	3 800	<b>7218BDB</b>	<b>7218BDF</b>	<b>7218BDT</b>	134.9	74.9	100	95.5	150	154.5	2	1	4.60
160		60	2	1	199	209	208	223	14.6	5 200	6 900	<b>7218CDB</b>	<b>7218CDF</b>	<b>7218CDT</b>	63.5	3.5	100	95.5	150	154.5	2	1	4.60
190		86	3	1.1	261	270	277	294	—	3 300	4 200	<b>7318DB</b>	<b>7318DF</b>	<b>7318DT</b>	123.9	37.9	104	97	176	183	2.5	1	10.6
190		86	3	1.1	240	248	254	270	—	2 500	3 300	<b>7318BDB</b>	<b>7318BDF</b>	<b>7318BDT</b>	160.5	74.5	104	97	176	183	2.5	1	10.6
190		86	3	1.1	281	289	297	315	13.5	4 600	6 100	<b>7318CDB</b>	<b>7318CDF</b>	<b>7318CDT</b>	80.5	5.5	104	97	176	183	2.5	1	10.6
225		108	4	1.5	351	393	—	—	—	2 100	3 100	<b>7418DB</b>	<b>7418DF</b>	<b>7418DT</b>	145.0	37.0	108	—	207	216.5	3	1.5	22.8
225		108	4	1.5	325	364	—	—	—	1 800	2 800	<b>7418BDB</b>	<b>7418BDF</b>	<b>7418BDT</b>	186.2	78.2	108	—	207	216.5	3	1.5	22.8
95		130	36	1.1	0.6	65.3	88.3	—	—	16.5	5 900	7 900	<b>7919CDB</b>	<b>7919CDF</b>	<b>7919CDT</b>	48.1	12.1	102	—	123	125.5	1	0.6
	130	36	1.1	0.6	28.1	32.1	—	—	8.8	7 400	11 000	<b>HAR919CDB</b>	<b>HAR919CDF</b>	<b>HAR919CDT</b>	48.1	12.1	102	—	123	125.5	1	0.6	1.25
	145	48	1.5	1	54.3	54.4	—	—	8.5	7 000	11 000	<b>HAR019CDB</b>	<b>HAR019CDF</b>	<b>HAR019CDT</b>	56.2	8.2	103.5	—	136.5	139.5	1.5	1	2.56
	145	48	1.5	1	108	134	—	—	—	3 900	4 800	<b>7019DB</b>	<b>7019DF</b>	<b>7019DT</b>	94.5	46.5	103.5	—	136.5	139.5	1.5	1	2.64

[Notes] 1) Limiting speeds shown above are applicable to machined cage bearings. Limiting speeds of pressed cage bearings should be kept to under 80% of this value. For bearings with 15° contact angle, this figure is applied to the high precision bearings ranked higher than class 5, used with machined cages or molded cages.

2) B, C or no indication after the bearing number indicates nominal contact angle of 40°, 15° and 30° respectively. [Remark] Standard cage types used for the above bearings are described earlier in this section.

# Angular contact ball bearings (matched pair)

$d$  (95) ~ (105) mm

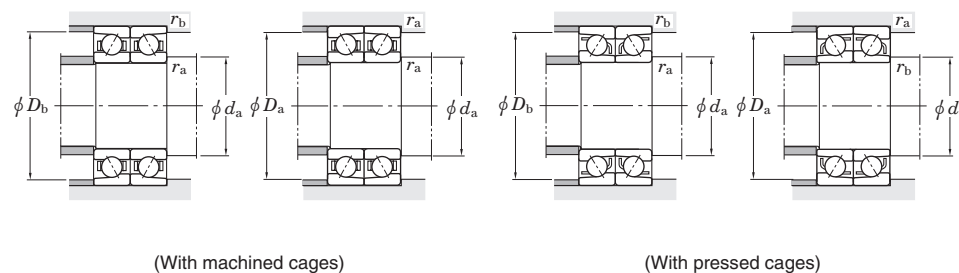
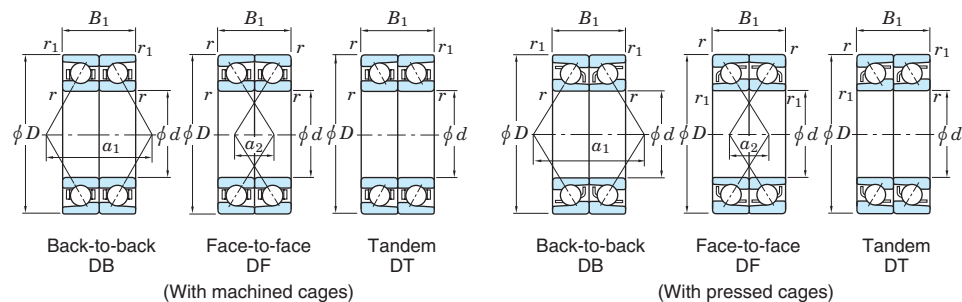

Boundary dimensions (mm)					Basic load ratings (kN)				Factor $f_0$	Limiting speeds <sup>1)</sup> (min <sup>-1</sup> )		Bearing No. <sup>2)</sup>			Load center spread (mm)		Mounting dimensions (mm)						(Refer.) Mass (kg)
$d$	$D$	$B_1$	$r$ min.	$r_1$ min.	With machined cages		With pressed cages			Grease lub.	Oil lub.	Back-to-back DB	Face-to-face DF	Tandem DT	$a_1$	$a_2$	$d_a$ min.	$d_b$ min.	$D_a$ max.	$D_b$ max.	$r_a$ max.	$r_b$ max.	
95	145	48	1.5	1	96.8	121	—	—	—	2 900	3 900	7019BDB	7019BDF	7019BDT	126.4	78.4	103.5	—	136.5	139.5	1.5	1	2.64
	145	48	1.5	1	119	147	—	—	15.9	5 300	7 100	7019CDB	7019CDF	7019CDT	56.7	8.7	103.5	—	136.5	139.5	1.5	1	2.64
	170	64	2.1	1.1	198	207	208	221	—	3 500	4 400	7219DB	7219DF	7219DT	108.5	44.5	107	102	158	163	2	1	5.56
	170	64	2.1	1.1	180	188	188	201	—	2 700	3 500	7219BDB	7219BDF	7219BDT	143.2	79.2	107	102	158	163	2	1	5.56
	170	64	2.1	1.1	216	224	226	240	14.6	4 900	6 500	7219CDB	7219CDF	7219CDT	67.5	3.5	107	102	158	163	2	1	5.56
	200	90	3	1.1	280	298	297	325	—	3 200	4 000	7319DB	7319DF	7319DT	130.2	40.2	109	102	186	193	2.5	1	12.2
	200	90	3	1.1	256	273	272	298	—	2 400	3 200	7319BDB	7319BDF	7319BDT	168.8	78.8	109	102	186	193	2.5	1	12.2
	200	90	3	1.1	300	319	318	348	13.5	4 400	5 800	7319CDB	7319CDF	7319CDT	84.5	5.5	109	102	186	193	2.5	1	12.2
100	140	40	1.1	0.6	90.2	117	—	—	16.3	5 500	7 400	7920CDB	7920CDF	7920CDT	52.1	12.1	107	—	133	135.5	1	0.6	1.55
	140	40	1.1	0.6	39.2	43.5	—	—	8.7	7 000	11 000	HAR920CDB	HAR920CDF	HAR920CDT	52.2	12.2	107	—	133	135.5	1	0.6	1.68
	150	48	1.5	1	55.2	56.7	—	—	8.5	6 700	10 000	HAR020CDB	HAR020CDF	HAR020CDT	57.5	9.5	108.5	—	141.5	144.5	1.5	1	2.64
	150	48	1.5	1	111	141	—	—	—	3 800	4 700	7020DB	7020DF	7020DT	96.2	48.2	108.5	—	141.5	144.5	1.5	1	2.74
	150	48	1.5	1	99.4	127	—	—	—	2 800	3 800	7020BDB	7020BDF	7020BDT	128.9	80.9	108.5	—	141.5	144.5	1.5	1	2.74
	150	48	1.5	1	122	154	—	—	16.0	5 200	6 900	7020CDB	7020CDF	7020CDT	57.5	9.5	108.5	—	141.5	144.5	1.5	1	2.74
	180	68	2.1	1.1	223	235	233	252	—	3 300	4 100	7220DB	7220DF	7220DT	115.4	47.4	112	—	168	173	2	1	6.64
	180	68	2.1	1.1	202	214	211	229	—	2 500	3 300	7220BDB	7220BDF	7220BDT	152.3	84.3	112	—	168	173	2	1	6.64
	180	68	2.1	1.1	242	254	254	273	14.6	4 600	6 100	7220CDB	7220CDF	7220CDT	71.8	3.8	112	107	168	173	2	1	6.64
	215	94	3	1.1	298	323	337	387	—	2 900	3 600	7320DB	7320DF	7320DT	138.8	44.8	114	—	201	208	2.5	1	15.1
	215	94	3	1.1	274	297	309	356	—	2 200	2 900	7320BDB	7320BDF	7320BDT	180.4	86.4	114	—	201	208	2.5	1	15.1
	215	94	3	1.1	320	346	361	415	13.4	4 000	5 300	7320CDB	7320CDF	7320CDT	89.6	4.4	114	107	201	208	2.5	1	15.1
105	145	40	1.1	0.6	92.1	123	—	—	16.4	5 300	7 100	7921CDB	7921CDF	7921CDT	53.5	13.5	112	—	138	140.5	1	0.6	1.62
	145	40	1.1	0.6	40.4	46.2	—	—	8.7	6 700	10 000	HAR921CDB	HAR921CDF	HAR921CDT	53.5	13.5	112	—	138	140.5	1	0.6	1.75
	160	52	2	1	62.6	65.1	—	—	8.5	6 300	9 800	HAR021CDB	HAR021CDF	HAR021CDT	61.5	9.5	115	—	150	154.5	2	1	3.37
	160	52	2	1	130	164	—	—	—	3 500	4 400	7021DB	7021DF	7021DT	103.7	51.7	115	—	150	154.5	2	1	3.46
	160	52	2	1	116	148	—	—	—	2 600	3 500	7021BDB	7021BDF	7021BDT	137.2	85.2	115	—	150	154.5	2	1	3.46
	160	52	2	1	143	179	—	—	15.9	4 800	6 400	7021CDB	7021CDF	7021CDT	62.0	10.0	115	—	150	154.5	2	1	3.46
	190	72	2.1	1.1	243	265	—	—	—	3 100	3 900	7221DB	7221DF	7221DT	122.1	50.1	117	—	178	183	2	1	7.90

[Notes] 1) Limiting speeds shown above are applicable to machined cage bearings. Limiting speeds of pressed cage bearings should be kept to under 80% of this value. For bearings with 15° contact angle, this figure is applied to the high precision bearings ranked higher than class 5, used with machined cages or molded cages.

2) B, C or no indication after the bearing number indicates nominal contact angle of 40°, 15° and 30° respectively. [Remark] Standard cage types used for the above bearings are described earlier in this section.

Angular contact ball bearings (matched pair)

d (105) ~ (120) mm

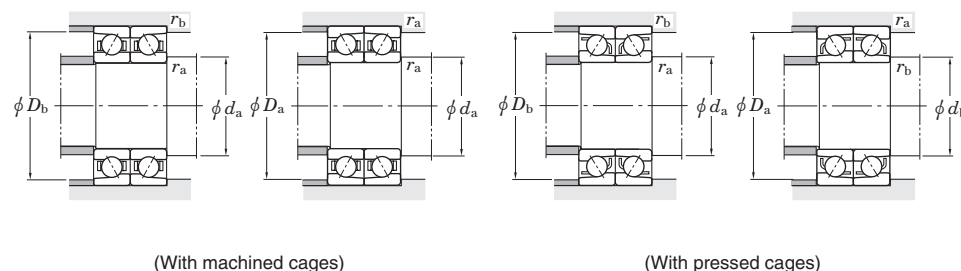
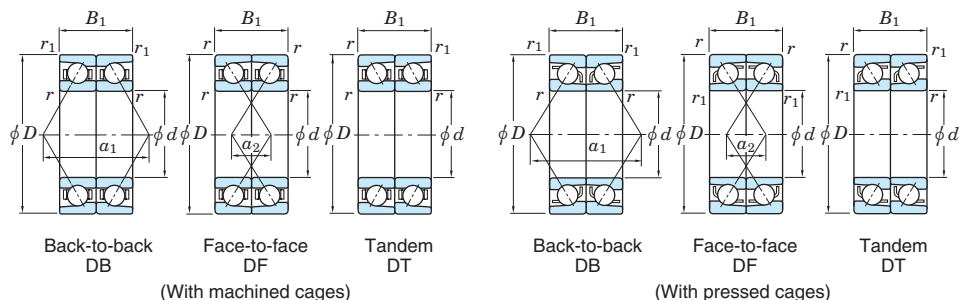

Boundary dimensions (mm)					Basic load ratings (kN)				Factor	Limiting speeds <sup>1)</sup> (min <sup>-1</sup> )		Bearing No. <sup>2)</sup>			Load center spread (mm)		Mounting dimensions (mm)						(Refer.) Mass (kg)
d	D	B <sub>1</sub>	r <sub>min.</sub>	r <sub>1 min.</sub>	With machined cages		With pressed cages			Grease lub.	Oil lub.	Back-to-back DB	Face-to-face DF	Tandem DT	α <sub>1</sub>	α <sub>2</sub>	d <sub>a min.</sub>	d <sub>b min.</sub>	D <sub>a max.</sub>	D <sub>b max.</sub>	r <sub>a max.</sub>	r <sub>b max.</sub>	
105	190	72	2.1	1.1	220	241	—	—	—	2 300	3 100	7221BDB	7221BDF	7221BDT	161.0	89.0	117	—	178	183	2	1	7.90
	190	72	2.1	1.1	264	287	—	—	14.6	4 300	5 700	7221CDB	7221CDF	7221CDT	75.9	3.9	117	—	178	183	2	1	7.90
	225	98	3	1.1	337	386	—	—	—	2 800	3 500	7321DB	7321DF	7321DT	144.3	46.3	119	—	211	218	2.5	1	17.2
	225	98	3	1.1	310	355	—	—	—	2 100	2 800	7321BDB	7321BDF	7321BDT	187.5	89.5	119	—	211	218	2.5	1	17.2
	225	98	3	1.1	362	413	—	—	13.4	3 900	5 100	7321CDB	7321CDF	7321CDT	93.2	4.8	119	—	211	218	2.5	1	17.2
110	150	40	1.1	0.6	93.8	129	—	—	16.5	5 100	6 800	7922CDB	7922CDF	7922CDT	54.8	14.8	117	—	143	145.5	1	0.6	1.68
	150	40	1.1	0.6	40.8	47.7	—	—	8.7	6 400	9 900	HAR922CDB	HAR922CDF	HAR922CDT	54.8	14.8	117	—	143	145.5	1	0.6	1.82
	170	56	2	1	70.5	73.9	—	—	8.5	6 000	9 200	HAR022CDB	HAR022CDF	HAR022CDT	65.5	9.5	120	—	160	164.5	2	1	4.22
	170	56	2	1	149	186	—	—	—	3 300	4 200	7022DB	7022DF	7022DT	108.9	52.9	120	—	160	164.5	2	1	4.28
	170	56	2	1	134	167	—	—	—	2 500	3 300	7022BDB	7022BDF	7022BDT	145.5	89.5	120	—	160	164.5	2	1	4.28
	170	56	2	1	164	203	—	—	15.7	4 600	6 100	7022CDB	7022CDF	7022CDT	65.5	9.5	120	—	160	164.5	2	1	4.28
	200	76	2.1	1.1	263	297	—	—	—	3 000	3 700	7222DB	7222DF	7222DT	128.7	52.7	122	—	188	193	2	1	9.30
	200	76	2.1	1.1	238	270	—	—	—	2 200	3 000	7222BDB	7222BDF	7222BDT	169.7	93.7	122	—	188	193	2	1	9.30
	200	76	2.1	1.1	286	321	—	—	14.5	4 100	5 400	7222CDB	7222CDF	7222CDT	80.1	4.1	122	—	188	193	2	1	9.30
	240	100	3	1.1	377	452	—	—	—	2 600	3 200	7322DB	7322DF	7322DT	152.7	52.7	124	—	226	233	2.5	1	20.2
	240	100	3	1.1	346	416	—	—	—	1 900	2 600	7322BDB	7322BDF	7322BDT	199.3	99.3	124	—	226	233	2.5	1	20.2
	240	100	3	1.1	404	484	—	—	13.4	3 500	4 700	7322CDB	7322CDF	7322CDT	97.7	2.3	124	—	226	233	2.5	1	20.2
	120	165	44	1.1	0.6	117	162	—	—	16.5	4 700	6 200	7924CDB	7924CDF	7924CDT	60.2	16.2	127	—	158	160.5	1	0.6
165		44	1.1	0.6	47.7	56.8	—	—	8.8	5 900	9 100	HAR924CDB	HAR924CDF	HAR924CDT	60.2	16.2	127	—	158	160.5	1	0.6	2.49
180		56	2	1	72.9	79.9	—	—	8.5	5 600	8 600	HAR024CDB	HAR024CDF	HAR024CDT	68.2	12.2	130	—	170	174.5	2	1	4.52
180		56	2	1	157	206	—	—	—	3 100	3 900	7024DB	7024DF	7024DT	114.6	58.6	130	—	170	174.5	2	1	4.54
180		56	2	1	140	186	—	—	—	2 300	3 100	7024BDB	7024BDF	7024BDT	153.9	97.9	130	—	170	174.5	2	1	4.54
180		56	2	1	173	226	—	—	16.0	4 300	5 700	7024CDB	7024CDF	7024CDT	68.2	12.2	130	—	170	174.5	2	1	4.54
215		80	2.1	1.1	283	332	—	—	—	2 700	3 400	7224DB	7224DF	7224DT	137.0	57.0	132	—	203	208	2	1	11.0
215		80	2.1	1.1	257	302	—	—	—	2 100	2 800	7224BDB	7224BDF	7224BDT	180.5	100.5	132	—	203	208	2	1	11.0
215		80	2.1	1.1	308	359	—	—	14.6	3 800	5 000	7224CDB	7224CDF	7224CDT	85.0	5.0	132	—	203	208	2	1	11.0
260		110	3	1.1	400	504	—	—	—	2 400	3 000	7324DB	7324DF	7324DT	164.7	54.7	134	—	246	253	2.5	1	25.2

[Notes] 1) Limiting speeds shown above are applicable to machined cage bearings. Limiting speeds of pressed cage bearings should be kept to under 80% of this value. For bearings with 15° contact angle, this figure is applied to the high precision bearings ranked higher than class 5, used with machined cages or molded cages.

2) B, C or no indication after the bearing number indicates nominal contact angle of 40°, 15° and 30° respectively. [Remark] Standard cage types used for the above bearings are described earlier in this section.

Angular contact ball bearings (matched pair)

d (120) ~ (150) mm

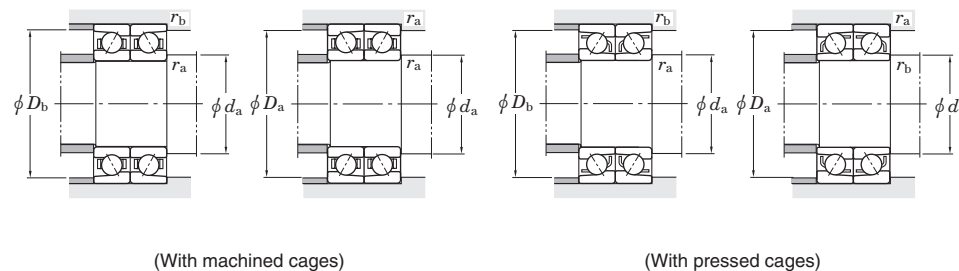
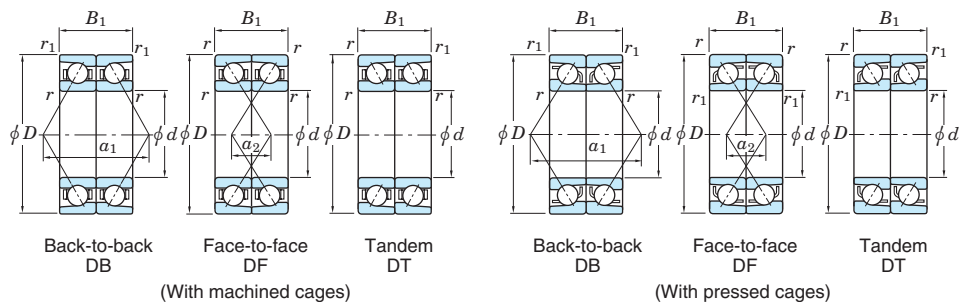

Boundary dimensions (mm)					Basic load ratings (kN)				Factor $f_0$	Limiting speeds <sup>1)</sup> (min <sup>-1</sup> )		Bearing No. <sup>2)</sup>			Load center spread (mm)		Mounting dimensions (mm)						(Refer.) Mass (kg)
d	D	B <sub>1</sub>	r <sub>min.</sub>	r <sub>1 min.</sub>	With machined cages		With pressed cages			Grease lub.	Oil lub.	Back-to-back DB	Face-to-face DF	Tandem DT	a <sub>1</sub>	a <sub>2</sub>	d <sub>a min.</sub>	d <sub>b min.</sub>	D <sub>a max.</sub>	D <sub>b max.</sub>	r <sub>a max.</sub>	r <sub>b max.</sub>	
120	260	110	3	1.1	366	462	—	—	—	1 800	2 400	7324BDB	7324BDF	7324BDT	214.4	104.4	134	—	246	253	2.5	1	25.2
	260	110	3	1.1	431	542	—	—	13.7	3 300	4 400	7324CDB	7324CDF	7324CDT	105.9	4.1	134	—	246	253	2.5	1	25.2
130	180	48	1.5	1	142	200	—	—	16.4	4 300	5 700	7926CDB	7926CDF	7926CDT	65.5	17.5	138.5	—	171.5	174.5	1.5	1	3.00
	180	48	1.5	1	57.0	70.3	—	—	8.8	5 400	8 300	HAR926CDB	HAR926CDF	HAR926CDT	65.5	17.5	138.5	—	171.5	174.5	1.5	1	3.32
	200	66	2	1	91.5	96.7	—	—	8.5	5 100	7 800	HAR026CDB	HAR026CDF	HAR026CDT	77.2	11.2	140	—	190	194.5	2	1	6.77
	200	66	2	1	191	251	—	—	—	2 800	3 500	7026DB	7026DF	7026DT	128.3	62.3	140	—	190	194.5	2	1	6.86
	200	66	2	1	171	226	—	—	—	2 100	2 800	7026BDB	7026BDF	7026BDT	171.5	105.5	140	—	190	194.5	2	1	6.86
	200	66	2	1	210	274	—	—	15.9	3 900	5 100	7026CDB	7026CDF	7026CDT	77.2	11.2	140	—	190	194.5	2	1	6.86
	230	80	3	1.1	318	395	—	—	—	2 500	3 200	7226DB	7226DF	7226DT	143.9	63.9	144	—	216	223	2.5	1	12.4
	230	80	3	1.1	288	360	—	—	—	1 900	2 500	7226BDB	7226BDF	7226BDT	191.0	111.0	144	—	216	223	2.5	1	12.4
	230	80	3	1.1	346	428	—	—	14.7	3 500	4 700	7226CDB	7226CDF	7226CDT	88.2	8.2	144	—	216	223	2.5	1	12.4
	280	116	4	1.5	489	659	—	—	—	2 200	2 700	7326DB	7326DF	7326DT	177.5	61.5	148	—	262	271.5	3	1.5	30.8
	280	116	4	1.5	406	536	—	—	—	1 600	2 200	7326BDB	7326BDF	7326BDT	230.0	114.0	148	—	262	271.5	3	1.5	30.8
	280	116	4	1.5	478	629	—	—	13.7	3 000	4 000	7326CDB	7326CDF	7326CDT	112.9	3.1	148	—	262	271.5	3	1.5	30.8
140	190	48	1.5	1	143	210	—	—	16.6	4 000	5 400	7928CDB	7928CDF	7928CDT	68.2	20.2	148.5	—	181.5	184.5	1.5	1	3.18
	190	48	1.5	1	57.2	72.4	—	—	8.8	5 100	7 800	HAR928CDB	HAR928CDF	HAR928CDT	68.2	20.2	148.5	—	181.5	184.5	1.5	1	3.52
	210	66	2	1	99.6	112	—	—	8.5	4 800	7 400	HAR028CDB	HAR028CDF	HAR028CDT	79.9	13.9	150	—	200	204.5	2	1	7.24
	210	66	2	1	194	265	—	—	—	2 600	3 300	7028DB	7028DF	7028DT	134.1	68.1	150	—	200	204.5	2	1	7.28
	210	66	2	1	174	237	—	—	—	2 000	2 600	7028BDB	7028BDF	7028BDT	179.8	113.8	150	—	200	204.5	2	1	7.28
	210	66	2	1	214	290	—	—	16.0	3 600	4 800	7028CDB	7028CDF	7028CDT	79.9	13.9	150	—	200	204.5	2	1	7.28
	250	84	3	1.1	355	468	—	—	—	2 300	2 900	7228DB	7228DF	7228DT	154.6	70.6	154	—	236	243	2.5	1	15.5
	250	84	3	1.1	320	426	—	—	—	1 700	2 300	7228BDB	7228BDF	7228BDT	205.6	121.6	154	—	236	243	2.5	1	15.5
	250	84	3	1.1	386	508	—	—	14.8	3 200	4 300	7228CDB	7228CDF	7228CDT	94.2	10.2	154	—	236	243	2.5	1	15.5
	300	124	4	1.5	535	748	—	—	—	2 000	2 500	7328DB	7328DF	7328DT	189.0	65.0	158	—	282	291.5	3	1.5	37.6
	300	124	4	1.5	491	688	—	—	—	1 500	2 000	7328BDB	7328BDF	7328BDT	246.6	122.6	158	—	282	291.5	3	1.5	37.6
	300	124	4	1.5	573	802	—	—	13.4	2 800	3 700	7328CDB	7328CDF	7328CDT	120.9	3.1	158	—	282	291.5	3	1.5	37.6
150	210	56	2	1	187	263	—	—	16.3	3 700	4 900	7930CDB	7930CDF	7930CDT	76.2	20.2	160	—	200	204.5	2	1	4.94

[Notes] 1) Limiting speeds shown above are applicable to machined cage bearings. Limiting speeds of pressed cage bearings should be kept to under 80% of this value. For bearings with 15° contact angle, this figure is applied to the high precision bearings ranked higher than class 5, used with machined cages or molded cages.

2) B, C or no indication after the bearing number indicates nominal contact angle of 40°, 15° and 30° respectively. [Remark] Standard cage types used for the above bearings are described earlier in this section.

Angular contact ball bearings (matched pair)

d (150) ~ (170) mm

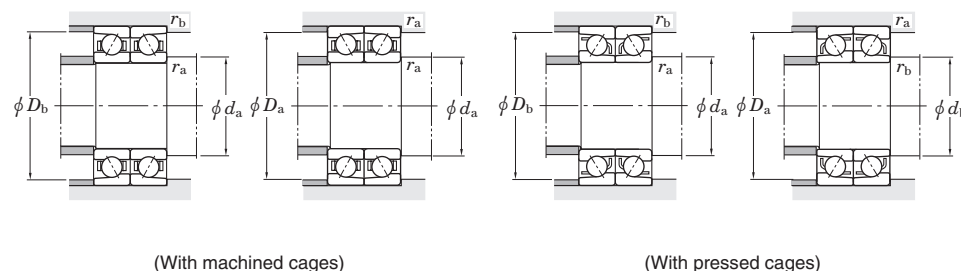
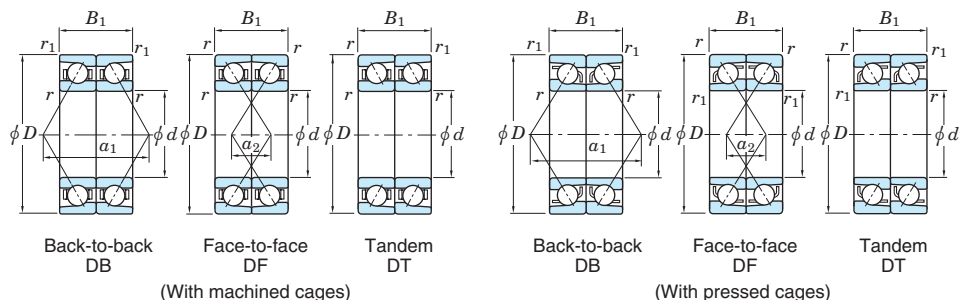

Boundary dimensions (mm)					Basic load ratings (kN)				Factor $f_0$	Limiting speeds <sup>1)</sup> (min <sup>-1</sup> )		Bearing No. <sup>2)</sup>			Load center spread (mm)		Mounting dimensions (mm)						(Refer.) Mass (kg)
$d$	$D$	$B_1$	$r$ min.	$r_1$ min.	With machined cages		With pressed cages			Grease lub.	Oil lub.	Back-to-back DB	Face-to-face DF	Tandem DT	$a_1$	$a_2$	$d_a$ min.	$d_b$ min.	$D_a$ max.	$D_b$ max.	$r_a$ max.	$r_b$ max.	
150	210	56	2	1	79.5	97.7	—	—	8.7	4 600	7 200	HAR930CDB	HAR930CDF	HAR930CDT	76.2	20.2	160	—	200	204.5	2	1	5.36
	225	70	2	1	117	132	—	—	8.5	4 200	6 500	HAR030CDB	HAR030CDF	HAR030CDT	85.2	15.2	160	—	215	219.5	2	1	8.72
	225	70	2.1	1.1	222	308	—	—	—	2 400	3 000	7030DB	7030DF	7030DT	144.2	74.2	162	—	213	218	2	1	8.86
	225	70	2.1	1.1	199	275	—	—	—	1 800	2 400	7030BDB	7030BDF	7030BDT	192.3	122.3	162	—	213	218	2	1	8.86
	225	70	2.1	1.1	245	337	—	—	16.1	3 300	4 400	7030CDB	7030CDF	7030CDT	85.6	15.6	162	—	213	218	2	1	8.86
	270	90	3	1.1	403	560	—	—	—	2 100	2 700	7230DB	7230DF	7230DT	166.3	76.3	164	—	256	263	2.5	1	19.5
	270	90	3	1.1	365	509	—	—	—	1 600	2 100	7230BDB	7230BDF	7230BDT	221.2	131.2	164	—	256	263	2.5	1	19.5
	270	90	3	1.1	439	607	—	—	14.7	2 900	3 900	7230CDB	7230CDF	7230CDT	101.3	11.3	164	—	256	263	2.5	1	19.5
	320	130	4	1.5	565	829	—	—	—	1 900	2 300	7330DB	7330DF	7330DT	200.7	70.7	168	—	302	311.5	3	1.5	44.8
	320	130	4	1.5	516	760	—	—	—	1 400	1 900	7330BDB	7330BDF	7330BDT	262.2	132.2	168	—	302	311.5	3	1.5	44.8
320	130	4	1.5	607	891	—	—	13.7	2 600	3 400	7330CDB	7330CDF	7330CDT	128.0	2.0	168	—	302	311.5	3	1.5	44.8	
160	220	56	2	1	196	289	—	—	16.5	3 500	4 700	7932CDB	7932CDF	7932CDT	78.9	22.9	170	—	210	214.5	2	1	5.20
	220	56	2	1	81.5	104	—	—	8.8	4 200	6 400	HAR932CDB	HAR932CDF	HAR932CDT	78.9	22.9	170	—	210	214.5	2	1	5.66
	240	76	2.1	1.1	127	145	—	—	8.5	4 000	6 100	HAR032CDB	HAR032CDF	HAR032CDT	91.6	15.6	172	—	228	233	2	1	10.8
	240	76	2.1	1.1	252	353	—	—	—	2 300	2 800	7032DB	7032DF	7032DT	153.5	77.5	172	—	228	233	2	1	10.9
	240	76	2.1	1.1	225	316	—	—	—	1 700	2 300	7032BDB	7032BDF	7032BDT	205.8	129.8	172	—	228	233	2	1	10.9
	240	76	2.1	1.1	278	386	—	—	16.0	3 100	4 100	7032CDB	7032CDF	7032CDT	91.6	15.6	172	—	228	233	2	1	10.9
	290	96	3	1.1	374	525	—	—	—	2 000	2 500	7232DB	7232DF	7232DT	177.9	81.9	174	—	276	283	2.5	1	24.2
	290	96	3	1.1	386	557	—	—	—	1 500	2 000	7232BDB	7232BDF	7232BDT	236.8	140.8	174	—	276	283	2.5	1	24.2
	290	96	3	1.1	465	665	—	—	15.2	2 700	3 600	7232CDB	7232CDF	7232CDT	108.3	12.3	174	—	276	283	2.5	1	24.2
	340	136	4	1.5	592	909	—	—	—	1 700	2 200	7332DB	7332DF	7332DT	212.3	76.3	178	—	322	331.5	3	1.5	52.8
340	136	4	1.5	540	831	—	—	—	1 300	1 700	7332BDB	7332BDF	7332BDT	277.8	141.8	178	—	322	331.5	3	1.5	52.8	
340	136	4	1.5	640	980	—	—	14.0	2 400	3 200	7332CDB	7332CDF	7332CDT	135.0	1.0	168.5	—	322	331.5	3	1.5	52.8	
170	230	56	2	1	199	302	—	—	16.6	3 100	4 100	7934CDB	7934CDF	7934CDT	81.6	25.6	180	—	220	224.5	2	1	6.42
	230	56	2	1	83.4	110	—	—	8.8	4 000	6 100	HAR934CDB	HAR934CDF	HAR934CDT	81.6	25.6	180	—	220	224.5	2	1	5.94
	260	84	2.1	1.1	149	173	—	—	8.5	3 700	5 700	HAR034CDB	HAR034CDF	HAR034CDT	99.6	15.6	182	—	248	253	2	1	14.6
	260	84	2.1	1.1	302	429	—	—	—	2 100	2 600	7034DB	7034DF	7034DT	166.2	82.2	182	—	248	253	2	1	15.2

[Notes] 1) Limiting speeds shown above are applicable to machined cage bearings. Limiting speeds of pressed cage bearings should be kept to under 80% of this value. For bearings with 15° contact angle, this figure is applied to the high precision bearings ranked higher than class 5, used with machined cages or molded cages.

2) B, C or no indication after the bearing number indicates nominal contact angle of 40°, 15° and 30° respectively. [Remark] Standard cage types used for the above bearings are described earlier in this section.



Angular contact ball bearings (matched pair)

d (170) ~ 190 mm

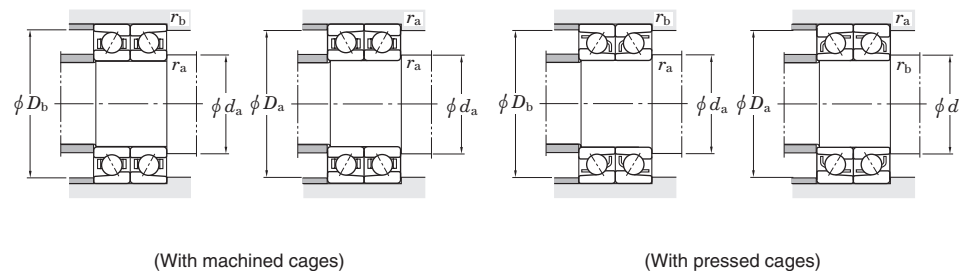
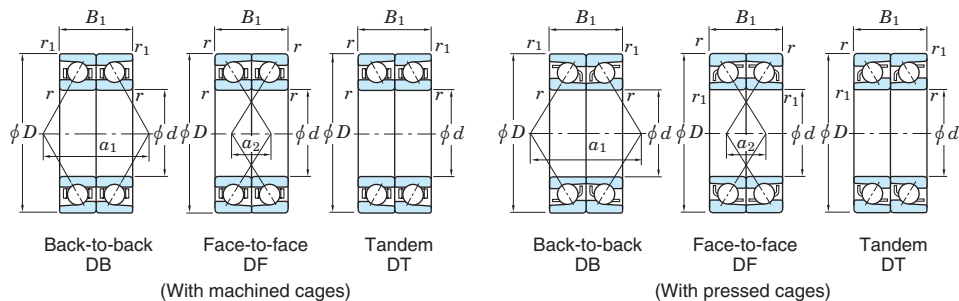

Boundary dimensions (mm)					Basic load ratings (kN)				Factor	Limiting speeds <sup>1)</sup> (min <sup>-1</sup> )		Bearing No. <sup>2)</sup>			Load center spread (mm)		Mounting dimensions (mm)						(Refer.) Mass (kg)
d	D	B <sub>1</sub>	r <sub>min.</sub>	r <sub>1 min.</sub>	With machined cages		With pressed cages			Grease lub.	Oil lub.	Back-to-back DB	Face-to-face DF	Tandem DT	a <sub>1</sub>	a <sub>2</sub>	d <sub>a min.</sub>	d <sub>b min.</sub>	D <sub>a max.</sub>	D <sub>b max.</sub>	r <sub>a max.</sub>	r <sub>b max.</sub>	
170	260	84	2.1	1.1	270	386	—	—	—	1 600	2 100	7034BDB	7034BDF	7034BDT	222.4	138.4	182	—	248	253	2	1	15.5
	260	84	2.1	1.1	332	469	—	—	15.9	2 900	3 800	7034CDB	7034CDF	7034CDT	99.6	15.6	182	—	248	253	2	1	15.1
	310	104	4	1.5	441	661	—	—	—	1 800	2 300	7234DB	7234DF	7234DT	190.6	86.6	188	—	292	301.5	3	1.5	30.2
	310	104	4	1.5	398	600	—	—	—	1 400	1 800	7234BDB	7234BDF	7234BDT	253.4	149.4	188	—	292	301.5	3	1.5	30.2
	310	104	4	1.5	482	719	—	—	15.1	2 500	3 300	7234CDB	7234CDF	7234CDT	116.3	12.3	188	—	292	301.5	3	1.5	30.2
	360	144	4	1.5	631	969	—	—	—	1 600	2 000	7334DB	7334DF	7334DT	225.0	81.0	188	—	342	351.5	3	1.5	62.4
	360	144	4	1.5	577	888	—	—	—	1 200	1 600	7334BDB	7334BDF	7334BDT	294.4	150.4	188	—	342	351.5	3	1.5	62.4
	360	144	4	1.5	679	1 040	—	—	13.8	2 200	3 000	7334CDB	7334CDF	7334CDT	143.0	1.0	188	—	342	351.5	3	1.5	62.4
180	250	66	2	1	253	375	—	—	16.4	2 800	3 700	7936CDB	7936CDF	7936CDT	90.6	24.6	190	—	240	244.5	2	1	9.36
	280	92	2.1	1.1	344	506	—	—	—	1 900	2 400	7036DB	7036DF	7036DT	178.8	86.8	192	—	268	273	2	1	20.2
	280	92	2.1	1.1	308	457	—	—	—	1 400	1 900	7036BDB	7036BDF	7036BDT	239.0	147.0	192	—	268	273	2	1	20.4
	280	92	2.1	1.1	378	553	—	—	15.7	2 600	3 500	7036CDB	7036CDF	7036CDT	107.6	15.6	192	—	268	273	2	1	19.9
	320	104	4	1.5	477	724	—	—	—	1 700	2 200	7236DB	7236DF	7236DT	196.3	92.3	198	—	302	311.5	3	1.5	31.4
	320	104	4	1.5	430	657	—	—	—	1 300	1 700	7236BDB	7236BDF	7236BDT	261.8	157.8	198	—	302	311.5	3	1.5	31.4
	320	104	4	1.5	520	786	—	—	14.9	2 400	3 200	7236CDB	7236CDF	7236CDT	119.0	15.0	198	—	302	311.5	3	1.5	31.4
	380	150	4	1.5	665	1 070	—	—	—	1 500	1 900	7336DB	7336DF	7336DT	236.7	86.7	198	—	362	371.5	3	1.5	80.0
380	150	4	1.5	606	976	—	—	—	1 100	1 500	7336BDB	7336BDF	7336BDT	309.9	159.9	198	—	362	371.5	3	1.5	80.0	
190	260	66	2	1	257	394	—	—	16.5	2 700	3 600	7938CDB	7938CDF	7938CDT	93.3	27.3	200	—	250	254.5	2	1	9.66
	290	92	2.1	1.1	353	535	—	—	—	1 800	2 300	7038DB	7038DF	7038DT	184.6	92.6	202	—	278	283	2	1	21.6
	290	92	2.1	1.1	316	483	—	—	—	1 400	1 800	7038BDB	7038BDF	7038BDT	247.4	155.4	202	—	278	283	2	1	21.6
	290	92	2.1	1.1	388	585	—	—	15.9	2 500	3 300	7038CDB	7038CDF	7038CDT	110.3	18.3	202	—	278	283	2	1	21.6
	340	110	4	1.5	493	779	—	—	—	1 600	2 000	7238DB	7238DF	7238DT	208.0	98.0	208	—	322	331.5	3	1.5	37.6
	340	110	4	1.5	443	706	—	—	—	1 200	1 600	7238BDB	7238BDF	7238BDT	277.4	167.4	208	—	322	331.5	3	1.5	37.6
	340	110	4	1.5	538	848	—	—	15.1	2 200	3 000	7238CDB	7238CDF	7238CDT	126.0	16.0	208	—	322	331.5	3	1.5	37.6
	400	156	5	2	731	1 200	—	—	—	1 400	1 800	7338DB	7338DF	7338DT	248.3	92.3	212	—	378	390	4	2	91.0
	400	156	5	2	668	1 100	—	—	—	1 100	1 400	7338BDB	7338BDF	7338BDT	325.5	169.5	212	—	378	390	4	2	91.0

[Notes] 1) Limiting speeds shown above are applicable to machined cage bearings. Limiting speeds of pressed cage bearings should be kept to under 80% of this value. For bearings with 15° contact angle, this figure is applied to the high precision bearings ranked higher than class 5, used with machined cages or molded cages.

2) B, C or no indication after the bearing number indicates nominal contact angle of 40°, 15° and 30° respectively. [Remark] Standard cage types used for the above bearings are described earlier in this section.

Angular contact ball bearings (matched pair)

d 200 ~ (340) mm

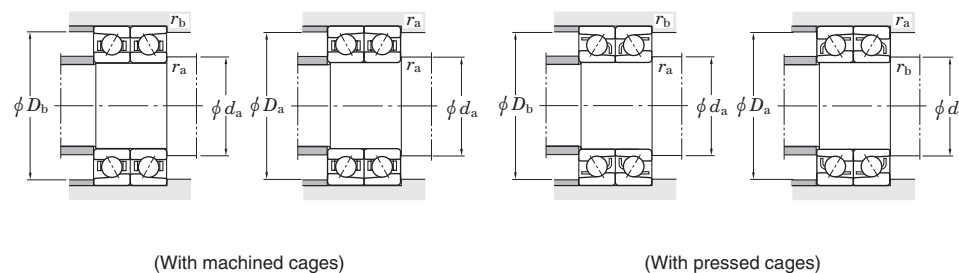
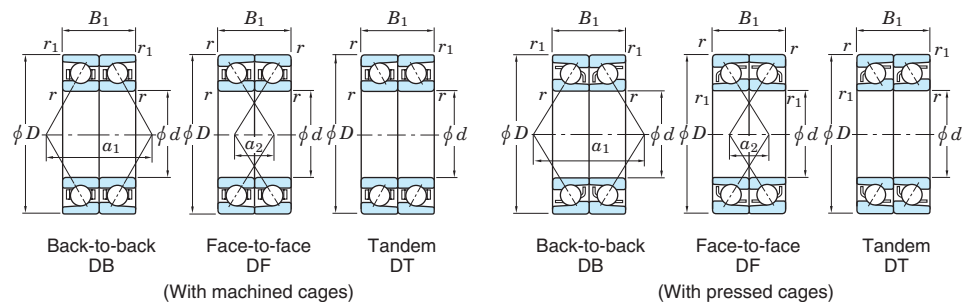

Boundary dimensions (mm)					Basic load ratings (kN)				Factor $f_0$	Limiting speeds <sup>1)</sup> (min <sup>-1</sup> )		Bearing No. <sup>2)</sup>			Load center spread (mm)		Mounting dimensions (mm)						(Refer.) Mass (kg)
$d$	$D$	$B_1$	$r$ min.	$r_1$ min.	With machined cages		With pressed cages			Grease lub.	Oil lub.	Back-to-back DB	Face-to-face DF	Tandem DT	$a_1$	$a_2$	$d_a$ min.	$d_b$ min.	$D_a$ max.	$D_b$ max.	$r_a$ max.	$r_b$ max.	
200	280	76	2.1	1.1	332	509	—	—	16.3	2 500	3 300	7940CDB	7940CDF	7940CDT	102.3	26.3	212	—	268	273	2	1	13.7
	310	102	2.1	1.1	396	618	—	—	—	1 700	2 100	7040DB	7040DF	7040DT	198.3	96.3	212	—	298	303	2	1	25.4
	310	102	2.1	1.1	355	558	—	—	—	1 300	1 700	7040BDB	7040BDF	7040BDT	265.0	163.0	212	—	298	303	2	1	25.4
	310	102	2.1	1.1	435	676	—	—	15.7	2 300	3 100	7040CDB	7040CDF	7040CDT	119.3	17.3	212	—	298	303	2	1	25.4
	360	116	4	1.5	526	847	—	—	—	1 500	1 900	7240DB	7240DF	7240DT	219.7	103.7	218	—	342	351.5	3	1.5	44.8
	360	116	4	1.5	474	768	—	—	—	1 100	1 500	7240BDB	7240BDF	7240BDT	292.9	176.9	218	—	342	351.5	3	1.5	44.8
	360	116	4	1.5	575	921	—	—	15.1	2 100	2 800	7240CDB	7240CDF	7240CDT	133.0	17.0	218	—	342	351.5	3	1.5	44.8
	420	160	5	2	770	1 320	—	—	—	1 300	1 700	7340DB	7340DF	7340DT	259.0	99.0	222	—	398	410	4	2	104
420	160	5	2	702	1 200	—	—	—	1 000	1 300	7340BDB	7340BDF	7340BDT	340.1	180.1	222	—	398	410	4	2	104	
220	340	112	3	1.1	434	705	—	—	—	1 500	1 900	7044DB	7044DF	—	217.8	105.8	234	—	326	333	2.5	1	37.0
	340	112	3	1.1	389	636	—	—	—	1 100	1 500	7044BDB	7044BDF	—	290.9	178.9	234	—	326	333	2.5	1	37.8
240	360	112	3	1.1	443	751	—	—	—	1 400	1 700	7048DB	7048DF	—	229.2	117.2	254	—	346	353	2.5	1	39.4
	360	112	3	1.1	397	677	—	—	—	1 000	1 400	7048BDB	7048BDF	—	307.7	195.7	254	—	346	353	2.5	1	40.2
	440	144	4	1.5	655	1 190	—	—	—	1 200	1 500	7248DB	7248DF	—	268.3	124.3	258	—	422	431.5	3	1.5	104
	440	144	4	1.5	589	1 080	—	—	—	890	1 200	7248BDB	7248BDF	—	357.3	213.3	258	—	422	431.5	3	1.5	106
260	400	130	4	1.5	529	956	—	—	—	1 200	1 500	7052DB	7052DF	—	256.7	126.7	278	—	382	391.5	3	1.5	57.4
	400	130	4	1.5	473	862	—	—	—	910	1 200	7052BDB	7052BDF	—	341.9	211.9	278	—	382	391.5	3	1.5	58.6
280	420	130	4	1.5	540	1 010	—	—	—	1 100	1 400	7056DB	7056DF	—	267.1	137.1	298	—	402	411.5	3	1.5	60.8
	420	130	4	1.5	483	906	—	—	—	850	1 100	7056BDB	7056BDF	—	358.7	228.7	298	—	402	411.5	3	1.5	62.0
300	460	148	4	1.5	693	1 360	—	—	—	1 000	1 300	7060DB	7060DF	—	293.4	145.4	318	—	442	451.5	3	1.5	87.4
	460	148	4	1.5	621	1 230	—	—	—	770	1 000	7060BDB	7060BDF	—	392.9	244.9	318	—	442	451.5	3	1.5	89.8
320	480	148	4	1.5	710	1 440	—	—	—	950	1 200	7064DB	7064DF	—	304.9	156.9	338	—	462	471.5	3	1.5	92.0
	480	148	4	1.5	636	1 300	—	—	—	710	950	7064BDB	7064BDF	—	409.6	261.6	338	—	462	471.5	3	1.5	94.4
340	520	164	5	2	816	1 720	—	—	—	860	1 100	7068DB	7068DF	—	330.3	166.3	362	—	498	510	4	2	124

[Notes] 1) Limiting speeds shown above are applicable to machined cage bearings. Limiting speeds of pressed cage bearings should be kept to under 80% of this value. For bearings with 15° contact angle, this figure is applied to the high precision bearings ranked higher than class 5, used with machined cages or molded cages.

2) B, C or no indication after the bearing number indicates nominal contact angle of 40°, 15° and 30° respectively. [Remark] Standard cage types used for the above bearings are described earlier in this section.



# Angular contact ball bearings (matched pair)

$d$  (340) ~ 380 mm

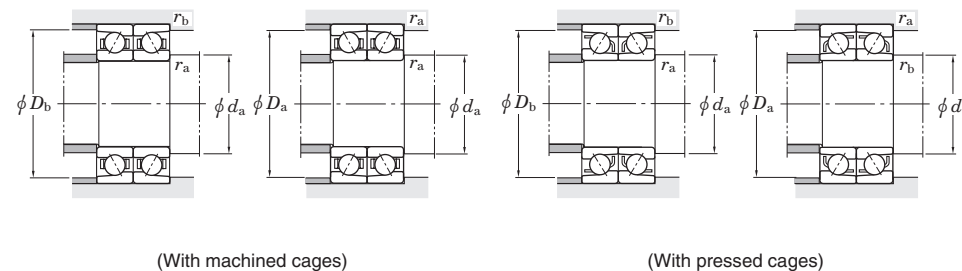
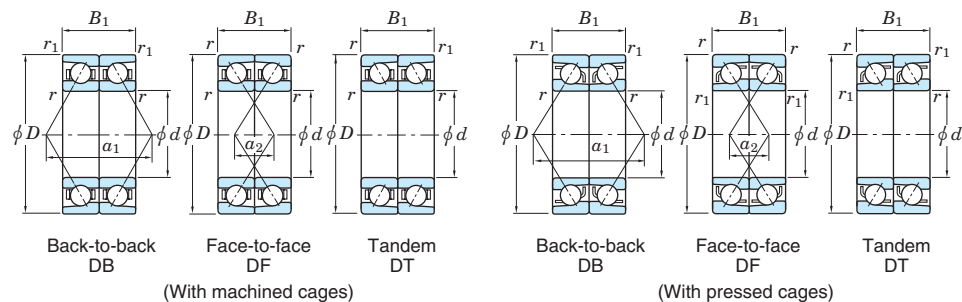

Boundary dimensions (mm)					Basic load ratings (kN)				Factor $f_0$	Limiting speeds <sup>1)</sup> ( $\text{min}^{-1}$ )		Bearing No. <sup>2)</sup>			Load center spread (mm)		Mounting dimensions (mm)						(Refer.) Mass (kg)
$d$	$D$	$B_1$	$r$ min.	$r_1$ min.	With machined cages		With pressed cages			Grease lub.	Oil lub.	Back-to-back DB	Face-to-face DF	Tandem DT	$a_1$	$a_2$	$d_a$ min.	$d_b$ min.	$D_a$ max.	$D_b$ max.	$r_a$ max.	$r_b$ max.	
340	520	164	5	2	731	1 550	—	—	—	640	860	7068BDB	7068BDF	—	442.8	278.8	362	—	498	510	4	2	127
	540	164	5	2	837	1 830	—	—	—	800	1 000	7072DB	7072DF	—	341.8	177.8	382	—	518	530	4	2	129
360	540	164	5	2	750	1 650	—	—	—	600	800	7072BDB	7072BDF	—	459.6	295.6	382	—	518	530	4	2	132
	560	164	5	2	858	1 930	—	—	—	750	940	7076DB	7076DF	—	353.4	189.4	402	—	538	550	4	2	134
380	560	164	5	2	767	1 740	—	—	—	560	750	7076BDB	7076BDF	—	476.4	312.4	402	—	538	550	4	2	138

[Notes] 1) Limiting speeds shown above are applicable to machined cage bearings. Limiting speeds of pressed cage bearings should be kept to under 80% of this value. For bearings with 15° contact angle, this figure is applied to the high precision bearings ranked higher than class 5, used with machined cages or molded cages.

2) B or no indication after the bearing number indicates nominal contact angle of 40° and 30° respectively. [Remark] Standard cage types used for the above bearings are described earlier in this section.

# Double-row angular contact ball bearings

$d$  10 ~ (40) mm

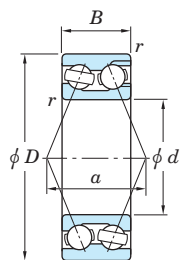

32, 33 series  
(With filling slot)

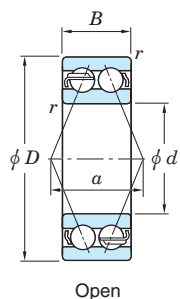

Open

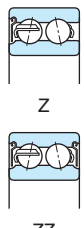

Shielded  
ZZ

52, 53 series  
(Without filling slot)



Contact sealed  
RS  
2RS

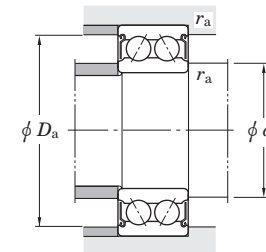
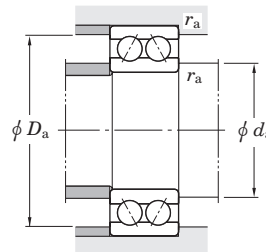

Boundary dimensions (mm)				Basic load ratings (kN)				Limiting speeds (min <sup>-1</sup> )			Bearing No.			Load center spread (mm)	Mounting dimensions <sup>1)</sup> (mm)				(Refer.) Mass (kg)
$d$	$D$	$B$	$r_{min.}$	Open		Shielded/sealed		Grease lub.	Oil lub.	Sealed	Open	Shielded	Sealed	Open $a$	$d_a$		$D_a$ max.	$r_a$ max.	Mass
				$C_r$	$C_{0r}$	$C_r$	$C_{0r}$								min.	max.			
10	30	14.3	0.6	7.35	5.35	—	—	15 000	—	20 000	3200	—	—	19.5	14.5	—	25.5	0.6	0.052
12	32	15.9	0.6	9.70	7.15	—	—	14 000	—	18 000	3201	—	—	21.7	16.5	—	27.5	0.6	0.063
15	35	15.9	0.6	9.70	7.45	—	—	12 000	—	16 000	3202	—	—	23.6	19.5	—	30.5	0.6	0.072
	42	19	1	15.2	11.9	—	—	10 000	—	14 000	3302	—	—	27.6	20.5	—	36.5	1	0.132
17	40	17.5	0.6	13.8	10.8	—	—	11 000	—	14 000	3203	—	—	26.6	21.5	—	35.5	0.6	0.100
	40	17.5	0.6	13.2	8.15	12.7	8.35	11 000	11 000	14 000	5203	5203 ZZ	5203 2RS	20.0	21.5	23.5	35.5	0.6	0.091
	47	22.2	1	21.7	17.1	—	—	9 400	—	13 000	3303	—	—	31.0	22.5	—	41.5	1	0.192
20	47	20.6	1	17.2	15.0	—	—	9 000	—	12 000	3204	—	—	31.5	25.5	—	41.5	1	0.170
	47	20.6	1	19.7	12.5	16.0	10.8	8 800	8 800	12 000	5204	5204 ZZ	5204 2RS	23.5	25.5	26.6	41.5	1	0.120
	52	22.2	1.1	20.8	18.4	—	—	8 200	—	11 000	3304	—	—	33.8	27	—	45	1	0.230
	52	22.2	1.1	24.7	15.0	19.8	12.8	8 300	8 300	11 000	5304	5304 ZZ	5304 2RS	25.9	27	28.3	45	1	0.230
25	52	20.6	1	18.9	18.2	—	—	7 800	—	10 000	3205	—	—	34.4	30.5	—	46.5	1	0.190
	52	20.6	1	21.4	14.8	18.9	13.8	7 700	7 700	10 000	5205	5205 ZZ	5205 2RS	26.1	30.5	32.3	46.5	1	0.190
	62	25.4	1.1	28.9	26.5	—	—	6 800	—	9 100	3305	—	—	40.5	32	—	55	1	0.369
	62	25.4	1.1	32.7	20.8	27.5	18.5	6 900	6 900	9 200	5305	5305 ZZ	5305 2RS	31.1	32	33.4	55	1	0.340
30	62	23.8	1	27.3	27.0	—	—	6 500	—	8 700	3206	—	—	40.7	35.5	—	56.5	1	0.320
	62	23.8	1	29.7	21.3	25.4	18.3	6 400	6 400	8 600	5206	5206 ZZ	5206 2RS	30.8	35.5	38.6	56.5	1	0.290
	72	30.2	1.1	38.1	36.1	—	—	5 800	—	7 800	3306	—	—	47.2	37	—	65	1	0.585
	72	30.2	1.1	41.0	28.5	34.3	25.2	5 800	5 800	7 700	5306	5306 ZZ	5306 2RS	36.2	37	41.3	65	1	0.510
35	72	27	1.1	36.8	37.5	—	—	5 600	—	7 500	3207	—	—	46.9	42	—	65	1	0.480
	72	27	1.1	39.2	29.0	31.7	24.6	5 500	5 500	7 300	5207	5207 ZZ	5207 2RS	36.1	42	43.9	65	1	0.430
	80	34.9	1.5	48.6	46.8	—	—	5 200	—	7 000	3307	—	—	53.4	43.5	—	71.5	1.5	0.816
	80	34.9	1.5	51.2	36.2	46.1	32.8	5 100	5 100	6 800	5307	5307 ZZ	5307 2RS	41.0	43.5	45.5	71.5	1.5	0.790
40	80	30.2	1.1	42.0	43.9	—	—	5 000	—	6 700	3208	—	—	52.6	47	—	73	1	0.650

[Note] 1) The maximum value of  $d_a$  is applied to shielded and sealed type bearings.

[Remark] Standard cage types used for the above bearings are described earlier in this section.

# Double-row angular contact ball bearings

$d$  (40) ~ (70) mm

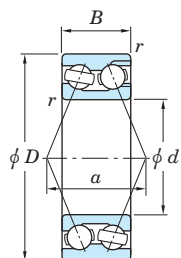

32, 33 series  
(With filling slot)

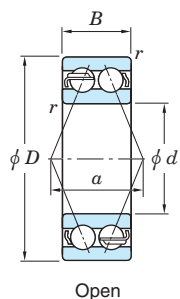

Open

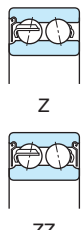

Shielded

52, 53 series  
(Without filling slot)



Contact sealed

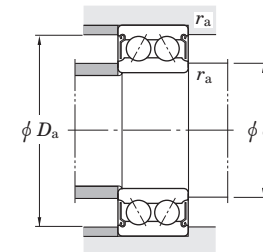
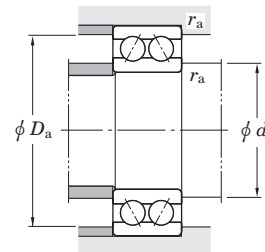

Boundary dimensions (mm)				Basic load ratings (kN)				Limiting speeds (min <sup>-1</sup> )			Bearing No.			Load center spread (mm)	Mounting dimensions <sup>1)</sup> (mm)				(Refer.) Mass (kg)
$d$	$D$	$B$	$r_{min.}$	Open		Shielded/sealed		Grease lub.		Oil lub.	Sealed	Open	Shielded	Open $\alpha$	$d_a$		$D_a$ max.	$r_a$ max.	Mass
				$C_r$	$C_{0r}$	$C_r$	$C_{0r}$	[Open Z, ZZ]	(RS, 2RS)	[Open Z]					min.	max.			
40	80	30.2	1.1	44.4	33.6	36.5	29.1	5 000	5 000	6 700	<b>5208</b>	<b>5208 ZZ</b>	<b>5208 2RS</b>	39.2	47	49.5	73	1	0.570
	90	36.5	1.5	54.1	53.8	—	—	4 600	—	6 100	<b>3308</b>	—	—	58.9	48.5	—	81.5	1.5	1.07
	90	36.5	1.5	62.7	45.4	51.4	37.8	4 600	4 600	6 100	<b>5308</b>	<b>5308 ZZ</b>	<b>5308 2RS</b>	44.9	48.5	52.1	81.5	1.5	1.05
45	85	30.2	1.1	45.4	51.4	—	—	4 600	—	6 100	<b>3209</b>	—	—	56.3	52	—	78	1	0.710
	85	30.2	1.1	49.9	38.4	41.7	33.9	4 600	4 600	6 100	<b>5209</b>	<b>5209 ZZ</b>	<b>5209 2RS</b>	42.2	52	55.3	78	1	0.620
	100	39.7	1.5	66.1	67.3	—	—	4 100	—	5 500	<b>3309</b>	—	—	65.6	53.5	—	91.5	1.5	1.42
	100	39.7	1.5	75.1	55.7	68.9	51.4	4 100	4 100	5 500	<b>5309</b>	<b>5309 ZZ</b>	<b>5309 2RS</b>	51.0	53.5	58.2	91.5	1.5	1.42
50	90	30.2	1.1	45.1	52.1	—	—	4 300	—	5 700	<b>3210</b>	—	—	58.8	57	—	83	1	0.760
	90	30.2	1.1	53.3	43.6	44.1	37.9	4 300	4 300	5 600	<b>5210</b>	<b>5210 ZZ</b>	<b>5210 2RS</b>	44.5	57	58.9	83	1	0.670
	110	44.4	2	86.1	88.6	—	—	3 800	—	5 000	<b>3310</b>	—	—	71.7	60	—	100	2	1.95
	110	44.4	2	88.5	67.0	81.8	62.2	3 600	3 600	4 800	<b>5310</b>	<b>5310 ZZ</b>	<b>5310 2RS</b>	56.6	60	64.4	100	2	1.93
55	100	33.3	1.5	50.9	60.2	—	—	3 900	—	5 100	<b>3211</b>	—	—	65.0	63.5	—	91.5	1.5	1.05
	100	33.3	1.5	65.9	55.2	52.9	44.7	3 800	3 800	5 100	<b>5211</b>	<b>5211 ZZ</b>	<b>5211 2RS</b>	50.2	63.5	66.2	91.5	1.5	0.960
	120	49.2	2	101	106	—	—	3 400	—	4 500	<b>3311</b>	—	—	79.3	65	—	110	2	2.53
	120	49.2	2	110	85.1	95.7	74.3	3 300	3 300	4 500	<b>5311</b>	<b>5311 ZZ</b>	<b>5311 2RS</b>	61.6	65	71.8	110	2	2.30
60	110	36.5	1.5	64.0	76.8	—	—	3 500	—	4 700	<b>3212</b>	—	—	71.3	68.5	—	101.5	1.5	1.40
	110	36.5	1.5	74.4	60.8	62.6	55.9	3 500	3 500	4 700	<b>5212</b>	<b>5212 ZZ</b>	<b>5212 2RS</b>	53.8	68.5	74.1	101.5	1.5	1.36
	130	54	2.1	125	132	—	—	3 100	—	4 200	<b>3312</b>	—	—	87.4	72	—	118	2	3.24
	130	54	2.1	126	98.7	110	87.1	3 100	3 100	4 100	<b>5312</b>	<b>5312 ZZ</b>	<b>5312 2RS</b>	67.2	72	79.2	118	2	3.16
65	120	38.1	1.5	76.4	97.4	—	—	3 200	—	4 300	<b>3213</b>	—	—	76.8	73.5	—	111.5	1.5	1.75
	120	38.1	1.5	86.9	75.3	69.2	63.1	3 200	3 200	4 300	<b>5213</b>	<b>5213 ZZ</b>	<b>5213 2RS</b>	58.8	73.5	79.0	111.5	1.5	1.66
	140	58.7	2.1	142	153	—	—	2 900	—	3 900	<b>3313</b>	—	—	92.7	77	—	128	2	4.08
	140	58.7	2.1	142	113	142	113	2 900	2 900	3 900	<b>5313</b>	<b>5313 ZZ</b>	<b>5313 2RS</b>	70.9	77	85.9	128	2	3.91
70	125	39.7	1.5	77.9	96.4	—	—	3 100	—	4 100	<b>3214</b>	—	—	80.7	78.5	—	116.5	1.5	1.92
	125	39.7	1.5	94.5	82.6	76.3	70.3	3 100	3 100	4 100	<b>5214</b>	<b>5214 ZZ</b>	<b>5214 2RS</b>	61.4	78.5	83.5	116.5	1.5	1.81
	150	63.5	2.1	151	160	—	—	2 700	—	3 600	<b>3314</b>	—	—	99.7	82	—	138	2	5.04

[Note] 1) The maximum value of  $d_a$  is applied to shielded and sealed type bearings.

[Remark] Standard cage types used for the above bearings are described earlier in this section.

# Double-row angular contact ball bearings

$d$  (70) ~ 110 mm

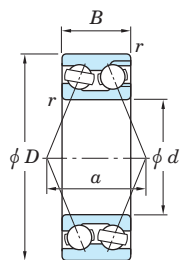

32, 33 series  
(With filling slot)

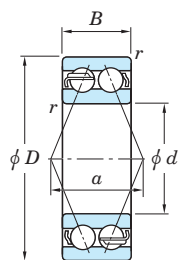

Open

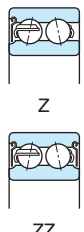

Z

ZZ

Shielded

52, 53 series  
(Without filling slot)



RS

2RS

Contact sealed

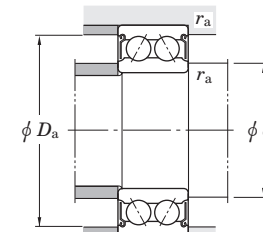
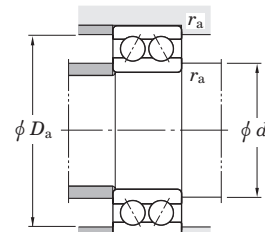

Boundary dimensions (mm)				Basic load ratings (kN)				Limiting speeds (min <sup>-1</sup> )			Bearing No.			Load center spread (mm)	Mounting dimensions <sup>1)</sup> (mm)				(Refer.) Mass (kg)
$d$	$D$	$B$	$r_{min.}$	Open		Shielded/sealed		Grease lub.		Oil lub.	Open	Shielded	Sealed		$\alpha$	$d_a$		$D_a$	
				$C_r$	$C_{0r}$	$C_r$	$C_{0r}$	[Open Z, ZZ]	(RS, 2RS)	[Open Z]	Open	Shielded		min.		max.	max.	max.	
<b>70</b>	150	63.5	2.1	160	129	160	129	2 700	2 700	3 600	<b>5314</b>	<b>5314 ZZ</b>	<b>5314 2RS</b>	76.0	82	92.9	138	2	4.89
<b>75</b>	130	41.3	1.5	92.4	120	—	—	2 900	—	3 900	<b>3215</b>	—	—	84.7	83.5	—	121.5	1.5	2.10
	160	68.3	2.1	169	189	—	—	2 500	—	3 300	<b>3315</b>	—	—	108.7	87	—	148	2	6.16
	160	68.3	2.1	174	147	174	147	2 500	2 500	3 300	<b>5315</b>	<b>5315 ZZ</b>	<b>5315 2RS</b>	81.5	87	99.6	148	2	5.97
<b>80</b>	140	44.4	2	97.5	121	—	—	2 700	—	3 600	<b>3216</b>	—	—	90.7	90	—	130	2	2.64
	170	68.3	2.1	184	213	—	—	2 400	—	3 100	<b>3316</b>	—	—	113.1	92	—	158	2	6.93
<b>85</b>	150	49.2	2	114	143	—	—	2 500	—	3 400	<b>3217</b>	—	—	98.4	95	—	140	2	3.39
	180	73	3	188	219	—	—	2 200	—	3 000	<b>3317</b>	—	—	118.8	99	—	166	2.5	8.30
<b>90</b>	160	52.4	2	132	167	—	—	2 400	—	3 100	<b>3218</b>	—	—	104.1	100	—	150	2	4.14
	190	73	3	205	242	—	—	2 100	—	2 800	<b>3318</b>	—	—	125.5	104	—	176	2.5	9.23
<b>95</b>	170	55.6	2.1	152	193	—	—	2 200	—	3 000	<b>3219</b>	—	—	110.6	107	—	158	2	5.00
	200	77.8	3	218	270	—	—	2 000	—	2 600	<b>3319</b>	—	—	132.2	109	—	186	2.5	10.9
<b>100</b>	180	60.3	2.1	172	221	—	—	2 100	—	2 800	<b>3220</b>	—	—	116.8	112	—	168	2	6.10
	215	82.6	3	249	324	—	—	1 800	—	2 500	<b>3320</b>	—	—	140.4	114	—	201	2.5	13.5
<b>105</b>	190	65.1	2.1	182	237	—	—	2 000	—	2 600	<b>3221</b>	—	—	124.2	117	—	178	2	7.37
	225	87.3	3	265	354	—	—	1 800	—	2 300	<b>3321</b>	—	—	148.1	119	—	211	2.5	15.6
<b>110</b>	200	69.8	2.1	201	263	—	—	1 900	—	2 500	<b>3222</b>	—	—	131.4	122	—	188	2	8.80
	240	92.1	3	281	388	—	—	1 600	—	2 200	<b>3322</b>	—	—	156.4	124	—	226	2.5	18.9

[Note] 1) The maximum value of  $d_a$  is applied to shielded and sealed type bearings.

[Remark] Standard cage types used for the above bearings are described earlier in this section.

# Four-point contact ball bearings

$d$  20 ~ 75 mm

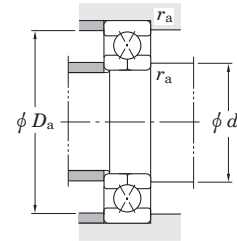
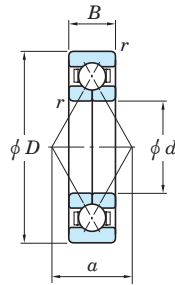

Boundary dimensions (mm)				Basic load ratings (kN)		Limiting speeds (min <sup>-1</sup> )		Bearing No.	Load center spread (mm) $a$	Mounting dimensions (mm)			(Refer.) Mass (kg)	
$d$	$D$	$B$	$r_{min.}$	$C_r$	$C_{0r}$	Grease lub.	Oil lub.			$d_a$ min.	$D_a$ max.	$r_a$ max.		
20	47	14	1	23.5	15.3	12 000	16 000	6204BI 6304BI	23.5		25.5	41.5	1	0.129
	52	15	1.1	27.4	18.1	11 000	15 000				27.0	45	1	
25	52	15	1	26.7	18.8	10 000	14 000	6205BI 6305BI	27.0		30.5	46.5	1	0.156
	62	17	1.1	40.8	28.0	9 200	13 000				32	55	1	
30	62	16	1	36.3	27.6	8 600	12 000	6206BI 6306BI	32.6		35.5	56.5	1	0.241
	72	19	1.1	49.5	36.6	7 800	11 000				37	65	1	
35	72	17	1.1	47.1	36.7	7 500	10 000	6207BI 6307BI	37.5		42	65	1	0.351
	80	21	1.5	61.2	46.4	7 000	9 600				43.5	71.5	1.5	
40	80	18	1.1	55.9	46.5	6 600	9 000	6208BI 6308BI	42.7		47	73	1	0.451
	90	23	1.5	74.1	57.6	6 200	8 500				48.5	81.5	1.5	
45	85	19	1.1	58.7	51.3	6 100	8 400	6209BI 6309BI	45.9		52	78	1	0.512
	100	25	1.5	87.9	70.0	5 500	7 600				53.5	91.5	1.5	
50	90	20	1.1	65.4	58.0	5 700	7 900	6210BI 6310BI	49.0		57	83	1	0.575
	110	27	2	103	83.7	5 000	6 900				60	100	2	
55	100	21	1.5	80.0	72.3	5 200	7 100	6211BI 6311BI	54.3		63.5	91.5	1.5	0.763
	120	29	2	119	98.5	4 500	6 200				65	110	2	
60	110	22	1.5	91.7	87.6	4 600	6 300	6212BI 6312BI	60.6		68.5	101.5	1.5	0.983
	130	31	2.1	145	126	4 100	5 700				72	118	2	
65	120	23	1.5	95.1	90.1	4 300	5 900	6213BI 6313BI	64.8		73.5	111.5	1.5	1.23
	140	33	2.1	164	145	3 800	5 300				77	128	2	
70	125	24	1.5	103	99.0	4 100	5 600	6214BI 6314BI	68.3		78.5	116.5	1.5	1.35
	150	35	2.1	184	165	3 600	4 900				82	138	2	
75	130	25	1.5	108	108	3 900	5 300	6215BI 6315BI	71.8		83.5	121.5	1.5	1.47
	160	37	2.1	200	187	3 400	4 600				87	148	2	

# Four-point contact ball bearings

$d$  80 ~ 110 mm

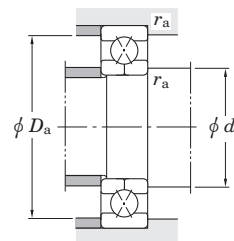
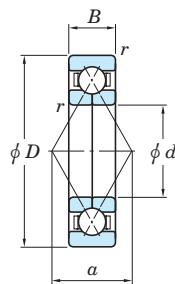

Boundary dimensions (mm)				Basic load ratings (kN)		Limiting speeds (min <sup>-1</sup> )		Bearing No.	Load center spread (mm) $a$	Mounting dimensions (mm)			(Refer.) Mass (kg)
$d$	$D$	$B$	$r_{min.}$	$C_r$	$C_{0r}$	Grease lub.	Oil lub.			$d_a$ min.	$D_a$ max.	$r_a$ max.	
<b>80</b>	140	26	2	126	128	3 600	4 900	<b>6216BI</b>	77.0	90	130	2	1.80
	170	39	2.1	217	210	3 100	4 300	<b>6316BI</b>	87.5	92	158	2	4.63
<b>85</b>	150	28	2	146	150	3 400	4 600	<b>6217BI</b>	82.3	95	140	2	2.25
	180	41	3	234	234	3 000	4 100	<b>6317BI</b>	92.8	99	166	2.5	5.45
<b>90</b>	160	30	2	167	173	3 100	4 300	<b>6218BI</b>	87.5	100	150	2	2.77
	190	43	3	252	260	2 800	3 800	<b>6318BI</b>	98.0	104	176	2.5	6.36
<b>95</b>	170	32	2.1	190	198	3 000	4 100	<b>6219BI</b>	92.8	107	158	2	3.37
	200	45	3	269	287	2 600	3 600	<b>6319BI</b>	103.3	109	186	2.5	7.37
<b>100</b>	180	34	2.1	201	213	2 800	3 800	<b>6220BI</b>	98.0	112	168	2	4.02
<b>110</b>	200	38	2.1	242	275	2 500	3 400	<b>6222BI</b>	108.5	122	188	2	5.64

## Self-aligning ball bearings

Self-aligning ball bearings have a spherical outer ring raceway, the center of whose curvature meets that of the bearing itself, so that the inner ring, balls and cage continue to rotate, aligning themselves if they have become misaligned within design limits.

This type of bearing is suitable when the displacement of the centers around which the shaft and housing rotate and shaft deflection are likely to occur.

Bearings with a tapered bore can easily be fit to the shaft with an adapter assembly.

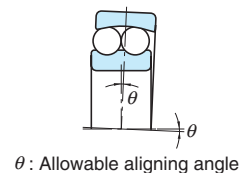

### Self-aligning ball bearings



Cylindrical bore



Tapered bore

Bore diameter **5 – 110 mm**



Sealed type

Bore diameter **10 – 110 mm**

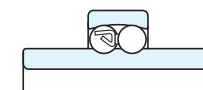

Extended inner ring type

Bore diameter **20 – 60 mm**

### Adapter assemblies



Bore diameter **17 – 100 mm**

Boundary dimensions	The dimensions of standard series are as specified in JIS B 1512.
Tolerances	As specified in JIS B 1514-1, class 0. (refer to Table 7-3 on pp. A 54 – A 57.)
Radial internal clearance	As specified in JIS B 1520. (refer to Table 10-6 on p. A 99.)
Recommended fits	Refer to Table 9-4 on pp. A 85, 86.
Standard cages	<ul style="list-style-type: none"> <li>Staggered type pressed steel cage (application : all dimensional range of 12, 13, 112, 113, 22...2RS and 23...2RS series)</li> <li>Snap type pressed steel cage (application : all dimensional range of 22 series and those of No. 2300 thru 2316.)</li> <li>Copper alloy machined cage (application : bearings of No. 2317 thru 2322)</li> </ul>
Allowable aligning angle	<ul style="list-style-type: none"> <li>12 and 22 series ..... 0.044 rad (2.5°)</li> <li>13 and 23 series ..... 0.052 rad (3°)</li> <li>22...2RS and 23...2RS series ..... 0.026 rad (1.5°)</li> </ul>

Dynamic equivalent radial load

$$P_r = X F_r + Y F_a$$

$F_a / F_r \leq e$		$F_a / F_r > e$	
X	Y	X	Y
1	$Y_1$	0.65	$Y_2$

Static equivalent radial load

$$P_{0r} = F_r + Y_0 F_a$$

Refer to the bearing specification table for values of  $e$ ,  $Y_1$ ,  $Y_2$  and  $Y_0$ .

Self-aligning ball bearings  
open type

d 5 ~ (20) mm

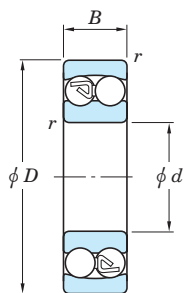

Cylindrical bore

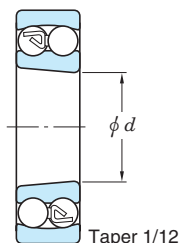

Tapered bore

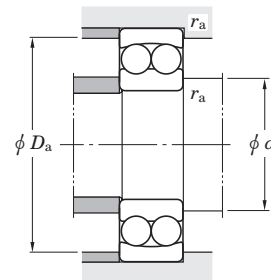

Boundary dimensions (mm)				Basic load ratings (kN)		Limiting speeds (min <sup>-1</sup> )		Bearing No.		Mounting dimensions (mm)			Con-stant e	Axial load factors			(Refer.) Mass (kg)	
d	D	B	r <sub>min.</sub>	C <sub>r</sub>	C <sub>0r</sub>	Grease lub.	Oil lub.	Cylindrical bore	Tapered bore	d <sub>a</sub> min.	D <sub>a</sub> max.	r <sub>a</sub> max.		Y <sub>1</sub>	Y <sub>2</sub>	Y <sub>0</sub>	Cylindrical bore	Tapered bore
5	19	6	0.3	2.55	0.48	30 000	37 000	135	—	7	17	0.3	0.34	1.86	2.87	1.94	0.009	—
6	19	6	0.3	2.50	0.48	30 000	37 000	126	—	8	17	0.3	0.34	1.86	2.87	1.94	0.009	—
7	22	7	0.3	2.65	0.56	27 000	33 000	127	—	9	20	0.3	0.35	1.82	2.82	1.91	0.014	—
8	22	7	0.3	2.60	0.56	26 000	33 000	108	—	10	20	0.3	0.35	1.82	2.82	1.91	0.014	—
9	26	8	0.6	3.80	0.80	23 000	29 000	129	—	13	22	0.6	0.34	1.86	2.87	1.94	0.022	—
10	30	9	0.6	5.50	1.20	23 000	28 000	1200	—	14	26	0.6	0.33	1.92	2.97	2.01	0.034	—
	30	14	0.6	7.40	1.60	23 000	29 000	2200	—	14	26	0.6	0.59	1.07	1.65	1.12	0.047	—
	35	11	0.6	7.25	1.60	20 000	24 000	1300	—	14	31	0.6	0.34	1.85	2.87	1.94	0.058	—
	35	17	0.6	9.30	2.10	18 000	24 000	2300	—	14	31	0.6	0.59	1.07	1.66	1.13	0.085	—
12	32	10	0.6	5.60	1.25	21 000	26 000	1201	—	16	28	0.6	0.33	1.89	2.93	1.98	0.040	—
	32	14	0.6	7.65	1.75	21 000	26 000	2201	—	16	28	0.6	0.53	1.18	1.83	1.24	0.053	—
	37	12	1	9.40	2.15	18 000	22 000	1301	—	17	32	1	0.36	1.77	2.74	1.86	0.067	—
	37	17	1	9.70	2.30	16 000	22 000	2301	—	17	32	1	0.54	1.17	1.81	1.23	0.095	—
15	35	11	0.6	7.45	1.75	18 000	22 000	1202	—	19	31	0.6	0.33	1.90	2.95	2.00	0.049	—
	35	14	0.6	7.70	1.85	18 000	22 000	2202	—	19	31	0.6	0.50	1.27	1.97	1.33	0.060	—
	42	13	1	9.55	2.30	16 000	20 000	1302	—	20	37	1	0.34	1.86	2.88	1.95	0.094	—
	42	17	1	12.1	2.90	14 000	20 000	2302	—	20	37	1	0.50	1.27	1.96	1.33	0.114	—
17	40	12	0.6	7.90	2.00	16 000	20 000	1203	—	21	36	0.6	0.31	2.03	3.14	2.12	0.073	—
	40	16	0.6	9.80	2.40	16 000	20 000	2203	—	21	36	0.6	0.50	1.27	1.96	1.33	0.088	—
	47	14	1	12.5	3.20	14 000	17 000	1303	—	22	42	1	0.33	1.92	2.97	2.01	0.130	—
	47	19	1	14.5	3.60	13 000	18 000	2303	—	22	42	1	0.49	1.28	1.98	1.34	0.158	—
20	47	14	1	9.90	2.60	14 000	17 000	1204	1204K	25	42	1	0.29	2.16	3.35	2.27	0.120	0.118
	47	18	1	12.6	3.30	14 000	17 000	2204	2204K	25	42	1	0.48	1.31	2.02	1.37	0.140	0.136
	52	15	1.1	12.4	3.30	13 000	15 000	1304	1304K	26.5	45.5	1	0.30	2.12	3.28	2.22	0.163	0.161

[Remark] Standard cage types used for the above bearings are described earlier in this section.



**Self-aligning ball bearings**  
**open type**

$d$  (20) ~ 50 mm

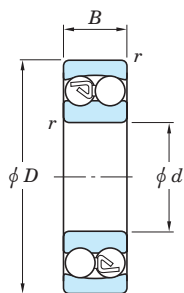

Cylindrical bore

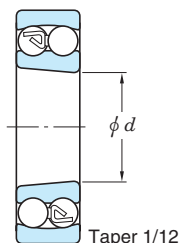

Tapered bore

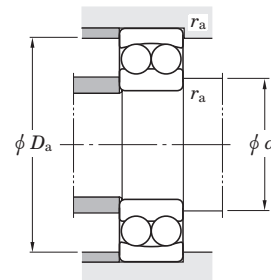

Boundary dimensions (mm)				Basic load ratings (kN)		Limiting speeds (min <sup>-1</sup> )		Bearing No.		Mounting dimensions (mm)			Con-stant $e$	Axial load factors			(Refer.) Mass (kg)	
$d$	$D$	$B$	$r_{min.}$	$C_r$	$C_{0r}$	Grease lub.	Oil lub.	Cylindrical bore	Tapered bore	$d_a$ min.	$D_a$ max.	$r_a$ max.		$Y_1$	$Y_2$	$Y_0$	Cylindrical bore	Tapered bore
<b>20</b>	52	21	1.1	18.0	4.70	11 000	15 000	<b>2304</b>	<b>2304K</b>	26.5	45.5	1	0.49	1.29	2.00	1.35	0.209	0.205
	52	15	1	12.1	3.30	12 000	14 000	<b>1205</b>	<b>1205K</b>	30	47	1	0.28	2.28	3.52	2.39	0.141	0.138
<b>25</b>	52	18	1	12.6	3.50	12 000	15 000	<b>2205</b>	<b>2205K</b>	30	47	1	0.40	1.58	2.45	1.66	0.163	0.158
	62	17	1.1	18.0	5.00	9 900	12 000	<b>1305</b>	<b>1305K</b>	31.5	55.5	1	0.27	2.31	3.57	2.42	0.257	0.252
	62	24	1.1	24.4	6.60	9 400	13 000	<b>2305</b>	<b>2305K</b>	31.5	55.5	1	0.46	1.36	2.10	1.42	0.335	0.327
	62	20	1	15.6	4.65	10 000	12 000	<b>2206</b>	<b>2206K</b>	35	57	1	0.35	1.79	2.77	1.87	0.260	0.254
<b>30</b>	62	16	1	15.6	4.65	9 900	12 000	<b>1206</b>	<b>1206K</b>	35	57	1	0.25	2.55	3.94	2.67	0.220	0.216
	72	19	1.1	21.3	6.30	8 700	11 000	<b>1306</b>	<b>1306K</b>	36.5	65.5	1	0.26	2.40	3.72	2.52	0.387	0.381
	72	27	1.1	31.4	8.75	8 000	11 000	<b>2306</b>	<b>2306K</b>	36.5	65.5	1	0.44	1.44	2.23	1.51	0.500	0.489
	72	23	1.1	21.6	6.60	8 500	10 000	<b>2207</b>	<b>2207K</b>	41.5	65.5	1	0.37	1.71	2.65	1.79	0.403	0.396
<b>35</b>	80	21	1.5	25.1	7.85	7 600	9 300	<b>1307</b>	<b>1307K</b>	43	72	1.5	0.25	2.48	3.84	2.60	0.510	0.502
	80	31	1.5	39.4	11.3	7 100	9 800	<b>2307</b>	<b>2307K</b>	43	72	1.5	0.45	1.39	2.15	1.46	0.675	0.657
	80	18	1.1	19.2	6.50	7 500	9 200	<b>1208</b>	<b>1208K</b>	46.5	73.5	1	0.22	2.83	4.38	2.97	0.417	0.411
	80	23	1.1	22.4	7.40	7 600	9 300	<b>2208</b>	<b>2208K</b>	46.5	73.5	1	0.33	1.92	2.96	2.01	0.505	0.494
<b>40</b>	90	23	1.5	29.5	9.70	6 900	8 400	<b>1308</b>	<b>1308K</b>	48	82	1.5	0.25	2.57	3.98	2.69	0.715	0.704
	90	33	1.5	44.9	13.5	6 200	8 600	<b>2308</b>	<b>2308K</b>	48	82	1.5	0.43	1.47	2.27	1.54	0.925	0.903
	85	19	1.1	21.8	7.35	7 000	8 500	<b>1209</b>	<b>1209K</b>	51.5	78.5	1	0.21	2.94	4.56	3.09	0.465	0.459
	85	23	1.1	23.3	8.15	7 000	8 500	<b>2209</b>	<b>2209K</b>	51.5	78.5	1	0.30	2.09	3.23	2.19	0.545	0.533
<b>45</b>	100	25	1.5	38.1	12.7	6 100	7 500	<b>1309</b>	<b>1309K</b>	53	92	1.5	0.25	2.56	3.95	2.68	0.957	0.942
	100	36	1.5	54.4	16.7	5 600	7 700	<b>2309</b>	<b>2309K</b>	53	92	1.5	0.42	1.51	2.33	1.58	1.23	1.20
	90	20	1.1	22.7	8.10	6 500	7 900	<b>1210</b>	<b>1210K</b>	56.5	83.5	1	0.21	3.07	4.76	3.22	0.525	0.515
	90	23	1.1	23.3	8.50	6 500	7 900	<b>2210</b>	<b>2210K</b>	56.5	83.5	1	0.27	2.33	3.61	2.45	0.590	0.577
<b>50</b>	110	27	2	43.4	14.1	5 600	6 800	<b>1310</b>	<b>1310K</b>	59	101	2	0.23	2.70	4.17	2.83	1.21	1.19
	110	40	2	64.6	20.3	5 100	7 000	<b>2310</b>	<b>2310K</b>	59	101	2	0.40	1.56	2.41	1.63	1.64	1.60

[Remark] Standard cage types used for the above bearings are described earlier in this section.

Self-aligning ball bearings  
open type

d 55 ~ (85) mm

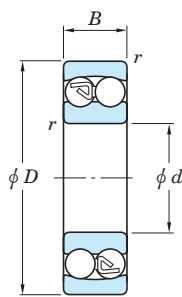

Cylindrical bore

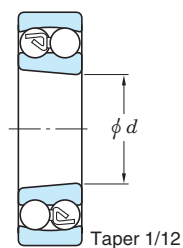

Tapered bore

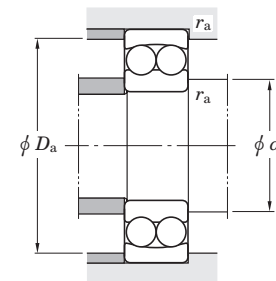

[Note] Protruding distance of balls

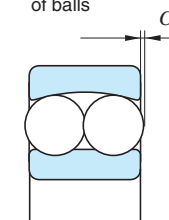

Balls of the following bearing protrude by C<sub>1</sub> from the bearing side.

Boundary dimensions (mm)				Basic load ratings (kN)		Limiting speeds (min <sup>-1</sup> )		Bearing No.		Mounting dimensions (mm)			Con-stant e	Axial load factors			(Refer.) Mass (kg)	
d	D	B	r min.	C <sub>r</sub>	C <sub>0r</sub>	Grease lub.	Oil lub.	Cylindrical bore	Tapered bore	d <sub>a</sub> min.	D <sub>a</sub> max.	r <sub>a</sub> max.		Y <sub>1</sub>	Y <sub>2</sub>	Y <sub>0</sub>	Cylindrical bore	Tapered bore
55	100	21	1.5	26.8	10.0	5 800	7 100	1211	1211K	63	92	1.5	0.20	3.19	4.94	3.34	0.705	0.693
	100	25	1.5	26.8	10.0	5 800	7 100	2211	2211K	63	92	1.5	0.27	2.35	3.64	2.47	0.810	0.792
	120	29	2	51.3	17.9	5 000	6 200	1311	1311K	64	111	2	0.23	2.70	4.18	2.83	1.58	1.56
	120	43	2	75.3	24.0	4 600	6 400	2311	2311K	64	111	2	0.41	1.53	2.37	1.60	2.10	2.05
60	110	22	1.5	30.2	11.5	5 200	6 400	1212	1212K	68	102	1.5	0.19	3.37	5.22	3.53	0.900	0.885
	110	28	1.5	34.1	12.6	5 300	6 500	2212	2212K	68	102	1.5	0.28	2.26	3.49	2.36	1.09	1.07
	130	31	2.1	57.2	20.8	4 500	5 500	1312	1312K	71	119	2	0.22	2.91	4.50	3.05	1.96	1.93
	130	46	2.1	87.2	28.3	4 200	5 800	2312	2312K	71	119	2	0.39	1.62	2.51	1.70	2.60	2.53
65	120	23	1.5	31.0	12.5	4 800	5 800	1213	1213K	73	112	1.5	0.17	3.67	5.68	3.84	1.15	1.13
	120	31	1.5	43.5	16.4	4 900	5 900	2213	2213K	73	112	1.5	0.28	2.24	3.47	2.35	1.46	1.43
	140	33	2.1	61.7	22.9	4 300	5 200	1313	1313K	76	129	2	0.23	2.73	4.23	2.86	2.45	2.41
	140	48	2.1	95.8	32.5	3 800	5 300	2313	2313K	76	129	2	0.38	1.66	2.58	1.74	3.23	3.15
70	125	24	1.5	34.6	13.8	4 600	5 700	1214	—	78	117	1.5	0.18	3.48	5.38	3.64	1.26	—
	125	31	1.5	43.9	17.1	4 600	5 600	2214	—	78	117	1.5	0.26	2.42	3.74	2.53	1.52	—
	150	35	2.1	74.0	27.7	4 000	4 900	1314	—	81	139	2	0.22	2.84	4.40	2.98	2.99	—
	150	51	2.1	89.6	31.7	3 600	4 900	2314	—	81	139	2	0.35	1.82	2.82	1.91	4.23	—
75	130	25	1.5	38.8	15.7	4 300	5 300	1215	1215K	83	122	1.5	0.17	3.60	5.58	3.77	1.36	1.34
	130	31	1.5	44.2	17.8	4 300	5 300	2215	2215K	83	122	1.5	0.25	2.49	3.85	2.61	1.62	1.58
	160	37	2.1	78.9	29.9	4 000	4 900	1315	1315K	86	149	2	0.23	2.80	4.33	2.93	3.56	3.51
	160	55	2.1	103	36.8	3 400	4 600	2315	2315K	86	149	2	0.34	1.86	2.88	1.95	5.13	5.01
80	140	26	2	39.8	17.0	4 000	4 900	1216	1216K	89	131	2	0.16	3.90	6.03	4.08	1.67	1.64
	140	33	2	49.0	19.9	4 100	5 000	2216	2216K	89	131	2	0.26	2.42	3.75	2.54	2.01	1.97
	170	39	2.1	88.1	33.1	3 500	4 300	1316	1316K	91	159	2	0.22	2.90	4.49	3.04	4.18	4.12
	170	58	2.1	129	45.7	3 100	4 300	2316	2316K	91	159	2	0.34	1.87	2.90	1.96	6.10	5.96
85	150	28	2	49.2	20.8	3 800	4 600	1217	1217K	94	141	2	0.17	3.61	5.59	3.78	2.07	2.04

[Remark] Standard cage types used for the above bearings are described earlier in this section.

Self-aligning ball bearings  
open type

d (85) ~ 110 mm

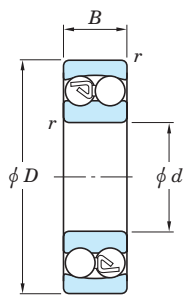

Cylindrical bore

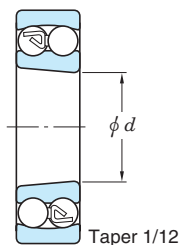

Tapered bore

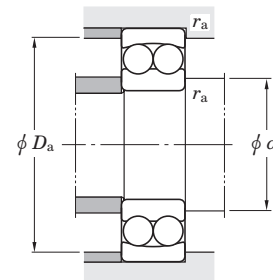

[Note] Protruding distance of balls

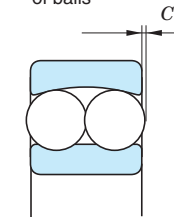

Balls of the following bearing protrude by C<sub>1</sub> from the bearing side.

Boundary dimensions (mm)				Basic load ratings (kN)		Limiting speeds (min <sup>-1</sup> )		Bearing No.		Mounting dimensions (mm)			Constant e	Axial load factors			(Refer.) Mass (kg)	
d	D	B	r <sub>min.</sub>	C <sub>r</sub>	C <sub>0r</sub>	Grease lub.	Oil lub.	Cylindrical bore	Tapered bore	d <sub>a</sub> min.	D <sub>a</sub> max.	r <sub>a</sub> max.		Y <sub>1</sub>	Y <sub>2</sub>	Y <sub>0</sub>	Cylindrical bore	Tapered bore
<b>85</b>	150	36	2	58.3	23.6	3 800	4 600	<b>2217</b>	<b>2217K</b>	94	141	2	0.25	2.49	3.85	2.61	2.52	2.46
	180	41	3	97.3	37.8	3 300	4 000	<b>1317</b>	<b>1317K</b>	98	167	2.5	0.22	2.93	4.53	3.07	4.98	4.91
	180	60	3	141	51.5	3 000	4 100	<b>2317</b>	<b>2317K</b>	98	167	2.5	0.35	1.82	2.82	1.91	7.05	6.89
<b>90</b>	160	30	2	56.8	23.4	3 500	4 300	<b>1218</b>	<b>1218K</b>	99	151	2	0.17	3.69	5.70	3.86	2.52	2.48
	160	40	2	67.7	27.2	3 500	4 300	<b>2218</b>	<b>2218K</b>	99	151	2	0.26	2.39	3.71	2.51	3.40	3.33
	190	43	3	116	44.4	3 100	3 800	<b>1318</b>	<b>1318K</b>	103	177	2.5	0.22	2.81	4.35	2.94	5.80	5.71
	190	64	3	153	57.9	2 800	3 900	<b>2318</b>	<b>2318K</b>	103	177	2.5	0.34	1.84	2.85	1.93	8.44	8.25
<b>95</b>	170	32	2.1	57.0	24.3	3 300	4 000	<b>1219</b>	<b>1219K</b>	106	159	2	0.17	3.63	5.62	3.80	3.10	3.05
	170	43	2.1	82.7	34.3	3 300	4 000	<b>2219</b>	<b>2219K</b>	106	159	2	0.26	2.43	3.76	2.55	4.10	4.00
	200	45	3	132	50.8	2 900	3 600	<b>1319</b>	<b>1319K</b>	108	187	2.5	0.23	2.73	4.23	2.86	6.69	6.59
	200	67	3	166	64.8	2 700	3 700	<b>2319</b>	<b>2319K</b>	108	187	2.5	0.35	1.82	2.82	1.91	9.79	9.57
<b>100</b>	180	34	2.1	69.0	29.7	3 100	3 800	<b>1220</b>	<b>1220K</b>	111	169	2	0.17	3.62	5.60	3.79	3.70	3.64
	180	46	2.1	80.9	34.0	3 100	3 800	<b>2220</b>	<b>2220K</b>	111	169	2	0.24	2.57	3.98	2.70	4.98	4.87
	215	47	3	143	57.3	2 800	3 400	<b>1320</b>	<b>1320K</b>	113	202	2.5	0.24	2.66	4.11	2.78	8.30	8.19
	215	73	3	183	73.4	2 400	3 400	<b>2320</b>	<b>2320K</b>	113	202	2.5	0.34	1.84	2.85	1.93	12.4	12.1
<b>105</b>	190	36	2.1	77.0	34.0	2 900	3 600	<b>1221</b>	—	116	179	2	0.18	3.56	5.51	3.73	4.37	—
	190	50	2.1	94.9	40.1	3 000	3 600	<b>2221</b>	—	116	179	2	0.26	2.43	3.76	2.55	6.07	—
	225	49	3	149	60.2	2 600	3 200	<b>1321</b>	—	118	212	2.5	0.23	2.73	4.22	2.86	10.0	—
	225	77	3	187	78.0	2 300	3 200	<b>2321</b>	—	118	212	2.5	0.36	1.75	2.71	1.83	14.3	—
<b>110</b>	200	38	2.1	80.2	35.2	2 800	3 400	<b>1222</b>	<b>1222K</b>	121	189	2	0.17	3.64	5.63	3.81	5.15	5.07
	200	53	2.1	120	48.9	2 800	3 400	<b>2222</b>	<b>2222K</b>	121	189	2	0.26	2.41	3.73	2.53	7.10	6.94
	240	50	3	150	63.2	2 400	3 000	<b>1322</b>	<b>1322K</b>	123	227	2.5	0.22	2.82	4.37	2.96	11.8	11.7
	240	80	3	200	85.7	2 200	3 000	<b>2322</b>	<b>2322K</b>	123	227	2.5	0.35	1.82	2.82	1.91	17.3	16.9

Bearing No.	C <sub>1</sub> (mm)
1319	1.6
1320	2.5
1321	2.5
1322	2.6

(approx.)

[Remark] Standard cage types used for the above bearings are described earlier in this section.

Self-aligning ball bearings  
sealed type

$d$  10 ~ 55 mm

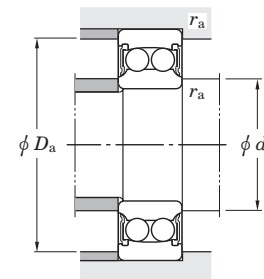
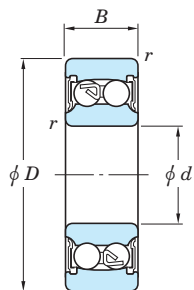

Boundary dimensions (mm)				Basic load ratings (kN)		Limiting speed (min <sup>-1</sup> )	Bearing No.	Mounting dimensions (mm)				Constant $e$	Axial load factors			(Refer.) Mass (kg)
$d$	$D$	$B$	$r_{min.}$	$C_r$	$C_{Or}$	Grease lub.		$d_a$ min.	$d_a$ max.	$D_a$ max.	$r_a$ max.		$Y_1$	$Y_2$	$Y_0$	
10	30	14	0.6	5.40	1.20	15 000	2200 2RS 2300 2RS	13.7	13.7	25	0.6	0.33	1.92	2.97	2.01	0.047
	35	17	0.6	7.25	1.60	13 000		15	15.7	30	0.6	0.34	1.85	2.87	1.94	0.085
12	32	14	0.6	5.60	1.25	14 000	2201 2RS 2301 2RS	15.2	15.2	27	0.6	0.33	1.89	2.93	1.98	0.053
	37	17	1	9.40	2.15	12 000		16.8	16.8	31	1	0.36	1.77	2.74	1.86	0.095
15	35	14	0.6	7.45	1.75	12 000	2202 2RS 2302 2RS	18.0	18.0	30	0.6	0.33	1.90	2.95	2.00	0.060
	42	17	1	9.55	2.30	11 000		20.0	20.0	36	1	0.34	1.86	2.88	1.95	0.114
17	40	16	0.6	7.90	2.00	11 000	2203 2RS 2303 2RS	20.2	20.2	35	0.6	0.31	2.03	3.14	2.12	0.088
	47	19	1	12.5	3.20	9 400		22.1	22.1	41	1	0.33	1.92	2.97	2.01	0.158
20	47	18	1	9.90	2.60	9 100	2204 2RS 2304 2RS	24.1	24.1	41	1	0.29	2.16	3.35	2.27	0.140
	52	21	1.1	12.4	3.35	8 300		26.2	26.2	45	1	0.30	2.12	3.28	2.22	0.209
25	52	18	1	12.1	3.30	7 900	2205 2RS 2305 2RS	29.4	29.4	46	1	0.28	2.28	3.52	2.39	0.163
	62	24	1.1	17.6	4.95	6 600		32	33.9	55	1	0.27	2.31	3.57	2.42	0.335
30	62	20	1	15.6	4.65	6 600	2206 2RS 2306 2RS	35.5	35.5	56	1	0.25	2.55	3.94	2.67	0.260
	72	27	1.1	21.3	6.30	5 800		37	37.8	65	1	0.26	2.40	3.72	2.52	0.500
35	72	23	1.1	15.8	5.10	5 700	2207 2RS 2307 2RS	40.9	40.9	65	1	0.23	2.71	4.20	2.84	0.403
	80	31	1.5	25.1	7.85	5 100		43.5	45.0	71.5	1.5	0.25	2.48	3.84	2.60	0.675
40	80	23	1.1	19.2	6.50	5 000	2208 2RS 2308 2RS	47	48.1	73	1	0.22	2.83	4.38	2.97	0.505
	90	33	1.5	29.5	9.70	4 600		48.5	49.6	81.5	1.5	0.25	2.57	3.98	2.69	0.925
45	85	23	1.1	21.8	7.35	4 600	2209 2RS 2309 2RS	52	52.4	78	1	0.21	2.94	4.56	3.09	0.545
	100	36	1.5	38.1	12.7	4 100		53.5	56.6	91.5	1.5	0.25	2.56	3.95	2.68	1.23
50	90	23	1.1	22.7	8.10	4 300	2210 2RS 2310 2RS	56.5	56.5	83	1	0.21	3.07	4.76	3.22	0.590
	110	40	2	43.4	14.1	3 700		60	62.5	100	2	0.23	2.70	4.17	2.83	1.64
55	100	25	1.5	26.8	10.0	3 900	2211 2RS 2311 2RS	63.5	63.5	91.5	1.5	0.20	3.19	4.94	3.34	0.810
	120	43	2	51.3	17.9	3 400		65	65	110	2	0.23	2.70	4.18	2.83	2.10

[Remark] Standard cage types used for the above bearings are described earlier in this section.

Self-aligning ball bearings  
sealed type

$d$  60 ~ 110 mm

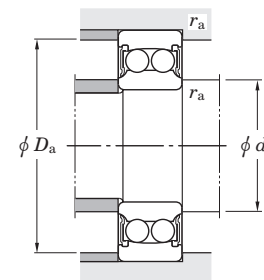
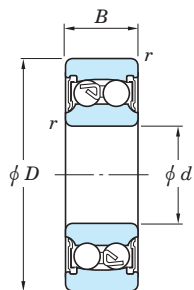

Boundary dimensions (mm)				Basic load ratings (kN)		Limiting speed (min <sup>-1</sup> )	Bearing No.	Mounting dimensions (mm)				Constant $e$	Axial load factors			(Refer.) Mass (kg)
$d$	$D$	$B$	$r_{min.}$	$C_r$	$C_{0r}$	Grease lub.		min. $d_a$	max. $d_a$	max. $D_a$	max. $r_a$		$Y_1$	$Y_2$	$Y_0$	
60	110	28	1.5	30.2	11.5	3 500	2212 2RS 2312 2RS	68.5	68.5	101.5	1.5	0.19	3.37	5.22	3.53	1.09
	130	46	2.1	57.1	20.8	3 000		72	72	118	2	0.22	2.91	4.50	3.05	2.60
65	120	31	1.5	31.0	12.5	3 200	2213 2RS 2313 2RS	73.5	75.5	111.5	1.5	0.17	3.67	5.68	3.84	1.46
	140	48	2.1	62.1	22.9	2 900		77	77	128	2	0.23	2.73	4.23	2.86	3.23
70	125	31	1.5	34.6	13.8	3 100	2214 2RS 2314 2RS	78.5	78.5	116.5	1.5	0.18	3.48	5.38	3.64	1.52
	150	51	2.1	74.1	27.7	2 600		82	82	138	2	0.22	2.84	4.40	2.98	4.23
75	130	31	1.5	38.8	15.7	2 900	2215 2RS 2315 2RS	83.5	83.5	121.5	1.5	0.17	3.60	5.58	3.77	1.62
	160	55	2.1	81.8	30.5	2 600		87	87	148	2	0.23	2.80	4.33	2.93	5.13
80	140	33	2	39.8	17.0	2 700	2216 2RS 2316 2RS	90	90	130	2	0.16	3.90	6.03	4.08	2.01
	170	58	2.1	88.4	33.1	2 300		92	92	158	2	0.22	2.90	4.49	3.04	6.10
85	150	36	2	49.2	20.8	2 500	2217 2RS	95	95	140	2	0.17	3.61	5.59	3.78	2.52
90	160	40	2	54.1	23.1	2 400	2218 2RS	100	100	150	2	0.17	3.69	5.70	3.86	3.40
95	170	43	2.1	60.8	26.8	2 200	2219 2RS	107	107	158	2	0.17	3.63	5.62	3.80	4.10
100	180	46	2.1	69.0	29.7	2 100	2220 2RS	112	112	168	2	0.17	3.62	5.60	3.79	4.98
105	190	50	2.1	77.0	34.0	2 000	2221 2RS	117	117	178	2	0.18	3.56	5.51	3.73	6.07
110	200	53	2.1	80.2	35.2	1 900	2222 2RS	122	122	188	2	0.17	3.64	5.63	3.81	7.10

[Remark] Standard cage types used for the above bearings are described earlier in this section.

Self-aligning ball bearings  
extended inner ring type

$d$  20 ~ 60 mm

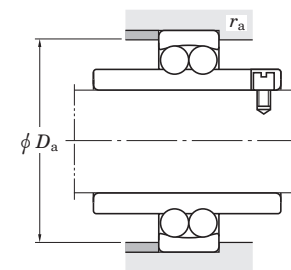
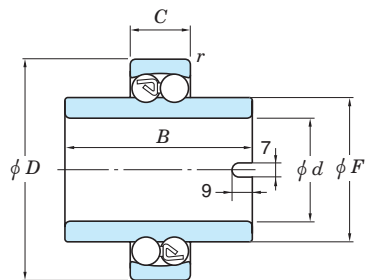

Boundary dimensions (mm)						Basic load ratings (kN)		Limiting speeds (min <sup>-1</sup> )		Bearing No.	Mounting dimensions (mm)		Constant $e$	Axial load factors			(Refer.) Mass (kg)
$d$	$D$	$B$	$C$	$F$	$r_{min.}$	$C_r$	$C_{0r}$	Grease lub.	Oil lub.		$D_a$ max.	$r_a$ max.		$Y_1$	$Y_2$	$Y_0$	
20	47	40	14	29.2	1	9.90	2.60	14 000	17 000	11204 11304	42	1	0.29	2.16	3.35	2.27	0.191
	52	44	15	31.5	1.1	12.4	3.35	13 000	15 000		45.5	1	0.30	2.12	3.28	2.22	0.266
25	52	44	15	33.3	1	12.1	3.30	12 000	14 000	11205 11305	47	1	0.28	2.28	3.52	2.39	0.226
	62	48	17	38	1.1	17.6	4.95	9 900	12 000		55.5	1	0.27	2.31	3.57	2.42	0.445
30	62	48	16	40.1	1	15.6	4.65	9 900	12 000	11206 11306	57	1	0.25	2.55	3.94	2.67	0.360
	72	52	19	45	1.1	21.3	6.30	8 700	11 000		65.5	1	0.26	2.40	3.72	2.52	0.614
35	72	52	17	47.7	1.1	15.8	5.10	8 500	10 000	11207 11307	65.5	1	0.23	2.71	4.20	2.84	0.556
	80	56	21	51.7	1.5	25.1	7.85	7 600	9 300		72	1.5	0.25	2.48	3.84	2.60	0.821
40	80	56	18	54	1.1	19.2	6.50	7 500	9 200	11208 11308	73.5	1	0.22	2.83	4.38	2.97	0.733
	90	58	23	57.7	1.5	29.5	9.70	6 900	8 400		82	1.5	0.25	2.57	3.98	2.69	1.09
45	85	58	19	57.7	1.1	21.8	7.35	7 000	8 500	11209 11309	78.5	1	0.21	2.94	4.56	3.09	0.793
	100	60	25	63.9	1.5	38.1	12.7	6 100	7 500		92	1.5	0.25	2.56	3.95	2.68	1.40
50	90	58	20	62.7	1.1	22.7	8.10	6 500	7 900	11210 11310	83.5	1	0.21	3.07	4.76	3.22	0.875
	110	62	27	70.3	2	43.4	14.1	5 600	6 800		102	2	0.23	2.70	4.17	2.83	1.74
55	100	60	21	70.3	1.5	26.8	10.0	5 800	7 100	11211	93.5	1.5	0.20	3.19	4.94	3.34	1.16
60	110	62	22	78	1.5	30.2	11.5	5 200	6 400	11212	103.5	1.5	0.19	3.37	5.22	3.53	1.52

Adapter assemblies for self-aligning ball bearings

$d_1$  17 ~ (45) mm

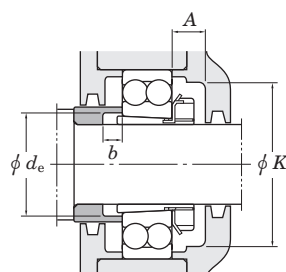
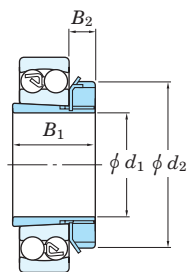

$d_1$  (45) ~ 75 mm

Boundary dimensions (mm)				Brg. bore $d$ (mm)	Designations Bearing + adapter ass'y	Mounting dimensions (mm)				Mass Brg.+adapter ass'y (kg)	(Refer.)	
$d_1$	$B_1$	$d_2$	$B_2$			A min.	K min.	$d_e$ min.	$b$ min.		Adapter sleeve No.	Locknut No.
17	24	32	7	20	1204K+H204X	—	—	23	5	0.162	A204X	AN04
	28	32	7	20	2204K+H304X	—	—	24	5	0.185	A304X	AN04
	28	32	7	20	1304K+H304X	—	—	24	8	0.210	A304X	AN04
	31	32	7	20	2304K+H2304X	—	—	24	5	0.257	A2304X	AN04
20	26	38	8	25	1205K+H205X	15	45	28	5	0.218	A205X	AN05
	29	38	8	25	2205K+H305X	15	45	29	5	0.243	A305X	AN05
	29	38	8	25	1305K+H305X	15	45	29	6	0.337	A305X	AN05
	35	38	8	25	2305K+H2305X	15	45	29	5	0.424	A2305X	AN05
25	27	45	8	30	1206K+H206X	15	50	33	5	0.320	A206X	AN06
	31	45	8	30	2206K+H306X	15	50	34	5	0.368	A306X	AN06
	31	45	8	30	1306K+H306X	15	50	34	6	0.495	A306X	AN06
	38	45	8	30	2306K+H2306X	15	50	35	5	0.620	A2306X	AN06
30	29	52	9	35	1207K+H207X	17	58	38	5	0.462	A207X	AN07
	35	52	9	35	2207K+H307X	17	58	39	5	0.557	A307X	AN07
	35	52	9	35	1307K+H307X	17	58	39	7	0.663	A307X	AN07
	43	52	9	35	2307K+H2307X	17	58	40	5	0.843	A2307X	AN07
35	31	58	10	40	1208K+H208X	17	65	44	5	0.597	A208X	AN08
	36	58	10	40	2208K+H308X	17	65	44	5	0.696	A308X	AN08
	36	58	10	40	1308K+H308X	17	65	44	5	0.906	A308X	AN08
	46	58	10	40	2308K+H2308X	17	65	45	5	1.14	A2308X	AN08
40	33	65	11	45	1209K+H209X	17	72	49	5	0.701	A209X	AN09
	39	65	11	45	2209K+H309X	17	72	49	8	0.798	A309X	AN09
	39	65	11	45	1309K+H309X	17	72	49	5	1.21	A309X	AN09
	50	65	11	45	2309K+H2309X	17	72	50	5	1.51	A2309X	AN09
45	35	70	12	50	1210K+H210X	19	76	53	5	0.804	A210X	AN10
	42	70	12	50	2210K+H310X	19	76	54	10	0.896	A310X	AN10

Boundary dimensions (mm)				Brg. bore $d$ (mm)	Designations Bearing + adapter ass'y	Mounting dimensions (mm)				Mass Brg.+adapter ass'y (kg)	(Refer.)	
$d_1$	$B_1$	$d_2$	$B_2$			A min.	K min.	$d_e$ min.	$b$ min.		Adapter sleeve No.	Locknut No.
45	42	70	12	50	1310K+H310X	19	76	54	5	1.51	A310X	AN10
	55	70	12	50	2310K+H2310X	19	76	56	5	1.98	A2310X	AN10
50	37	75	12	55	1211K+H211X	19	85	60	6	1.02	A211X	AN11
	45	75	12	55	2211K+H311X	19	85	60	11	1.16	A311X	AN11
	45	75	12	55	1311K+H311X	19	85	60	6	1.93	A311X	AN11
	59	75	12	55	2311K+H2311X	19	85	61	6	2.50	A2311X	AN11
55	38	80	13	60	1212K+H212X	20	90	61	5	1.25	A212X	AN12
	47	80	13	60	2212K+H312X	20	90	65	9	1.49	A312X	AN12
	47	80	13	60	1312K+H312X	20	90	65	5	2.35	A312X	AN12
	62	80	13	60	2312K+H2312X	20	90	66	5	3.04	A2312X	AN12
60	40	85	14	65	1213K+H213X	21	96	70	5	1.56	A213X	AN13
	50	85	14	65	2213K+H313X	21	96	70	8	1.92	A313X	AN13
	50	85	14	65	1313K+H313X	21	96	70	5	2.90	A313X	AN13
	65	85	14	65	2313K+H2313X	21	96	72	5	3.74	A2313X	AN13
65	43	98	15	75	1215K+H215X	23	110	80	5	2.09	A215X	AN15
	55	98	15	75	2215K+H315X	23	110	80	12	2.47	A315X	AN15
	55	98	15	75	1315K+H315X	23	110	80	5	4.40	A315X	AN15
	73	98	15	75	2315K+H2315X	23	110	82	5	6.12	A2315X	AN15
70	46	105	17	80	1216K+H216X	25	120	85	5	2.57	A216X	AN16
	59	105	17	80	2216K+H316X	25	120	86	12	3.06	A316X	AN16
	59	105	17	80	1316K+H316X	25	120	86	5	5.21	A316X	AN16
	78	105	17	80	2316K+H2316X	25	120	87	5	7.30	A2316X	AN16
75	50	110	18	85	1217K+H217X	27	128	90	6	3.11	A217X	AN17
	63	110	18	85	2217K+H317X	27	128	91	12	3.70	A317X	AN17
	63	110	18	85	1317K+H317X	27	128	91	6	6.15	A317X	AN17
	82	110	18	85	2317K+H2317X	27	128	94	6	8.41	A2317X	AN17

Adapter assemblies for self-aligning ball bearings

$d_1$  80 ~ 100 mm

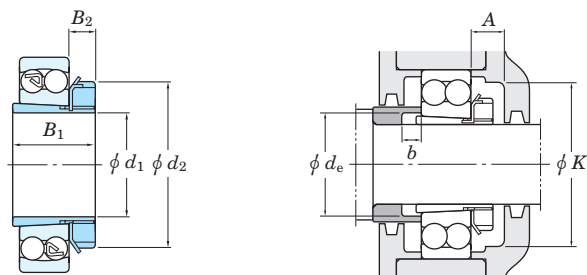

Boundary dimensions (mm)				Brg. bore <i>d</i> (mm)	Designations Bearing + adapter ass'y	Mounting dimensions (mm)				Mass Brg.+adapter ass'y (kg)	(Refer.)	
$d_1$	$B_1$	$d_2$	$B_2$			<i>A</i> min.	<i>K</i> min.	$d_e$ min.	<i>b</i> min.		Adapter sleeve No.	Locknut No.
<b>80</b>	52	120	18	90	1218K+ <b>H218X</b>	28	139	95	6	3.75	A218X	AN18
	65	120	18	90	2218K+ <b>H318X</b>	28	139	96	10	4.78	A318X	AN18
	65	120	18	90	1318K+ <b>H318X</b>	28	139	96	6	7.16	A318X	AN18
	86	120	18	90	2318K+ <b>H2318X</b>	28	139	99	6	9.95	A2318X	AN18
<b>85</b>	55	125	19	95	1219K+ <b>H219X</b>	29	145	101	7	4.47	A219X	AN19
	68	125	19	95	2219K+ <b>H319X</b>	29	145	102	9	5.62	A319X	AN19
	68	125	19	95	1319K+ <b>H319X</b>	29	145	102	7	8.21	A319X	AN19
	90	125	19	95	2319K+ <b>H2319X</b>	29	145	105	7	11.6	A2319X	AN19
<b>90</b>	58	130	20	100	1220K+ <b>H220X</b>	30	150	106	7	5.23	A220X	AN20
	71	130	20	100	2220K+ <b>H320X</b>	30	150	107	8	6.67	A320X	AN20
	71	130	20	100	1320K+ <b>H320X</b>	30	150	107	7	9.99	A320X	AN20
	97	130	20	100	2320K+ <b>H2320X</b>	30	150	110	7	14.4	A2320X	AN20
<b>100</b>	63	145	21	110	1222K+ <b>H222X</b>	32	170	116	7	7.10	A222X	AN22
	77	145	21	110	2222K+ <b>H322X</b>	32	170	117	6	9.23	A322X	AN22
	77	145	21	110	1322K+ <b>H322X</b>	32	170	117	9	14.0	A322X	AN22
	105	145	21	110	2322K+ <b>H2322X</b>	32	170	121	7	19.8	A2322X	AN22



## Cylindrical roller bearings

Cylindrical roller bearings feature high radial load capacity because the rollers and raceway are in linear contact. These bearings are suitable for applications that involve heavy radial and impact loading.

They are also appropriate for high-speed applications in that they can be machined very accurately due to their structure.

Having a separable inner ring or outer ring, these bearings can be mounted and dismantled easily.

### ■ Single-row cylindrical roller bearings

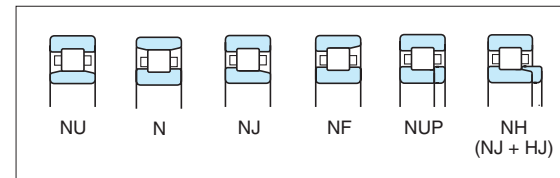

- The NU and N types exhibit their best performance when used as free side bearings since they adjust to the shaft's axial movement, to a certain extent, relative to the housing position.
- The NJ and NF types carry axial load in one direction, while the NUP and NH types can carry a certain degree of axial load in both directions.
- Type R cylindrical roller bearings feature enhanced load rating compared with standard series, though both have equal dimensions. This is because type R bearings have different internal design. They are identified by supplementary code "R".

### ■ Double-row cylindrical roller bearings

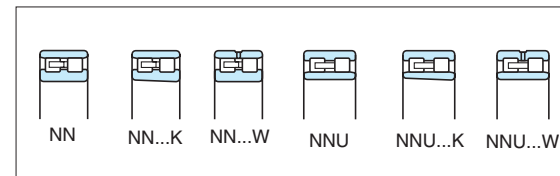

- Double-row cylindrical roller bearings come in two types : with a cylindrical bore, and with a tapered bore. As for those with a tapered bore, the specified amount of clearance can be obtained by adjusting the press-in distance. Some bearings have lubrication holes and lubrication grooves on the outer ring. They are identified by supplementary code "W".
- These bearings can accommodate high radial loads, and are often used on machine tool spindles.

### Single-row cylindrical roller bearings



Bore diameter **20 – 460 mm**



Thrust collar

Bore diameter **20 – 320 mm**

### Double-row cylindrical roller bearings

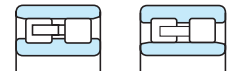

NN

NNU

Bore diameter **25 – 480 mm**



Boundary dimensions	The dimensions of standard series are as specified in JIS B 1512.																																																												
Tolerances	As specified in JIS B 1514-1 (refer to Table 7-3 on pp. A 54 – A 57).																																																												
	Tolerances of roller set bore diameter $F_w$ and roller set outside diameter $E_w$ of interchangeable bearings are as follows : Unit : $\mu\text{m}$																																																												
	<table border="1"> <thead> <tr> <th colspan="2">Nominal bore diameter <math>d</math> (mm)</th> <th colspan="2"><math>\Delta_{Fw}</math> Roller set bore diameter deviation</th> <th colspan="2"><math>\Delta_{Ew}</math> Roller set outside diameter deviation</th> </tr> <tr> <th>over</th> <th>up to</th> <th>upper</th> <th>lower</th> <th>upper</th> <th>lower</th> </tr> </thead> <tbody> <tr> <td>–</td> <td>20</td> <td>+ 10</td> <td>0</td> <td>0</td> <td>– 10</td> </tr> <tr> <td>20</td> <td>50</td> <td>+ 15</td> <td>0</td> <td>0</td> <td>– 15</td> </tr> <tr> <td>50</td> <td>120</td> <td>+ 20</td> <td>0</td> <td>0</td> <td>– 20</td> </tr> <tr> <td>120</td> <td>200</td> <td>+ 25</td> <td>0</td> <td>0</td> <td>– 25</td> </tr> <tr> <td>200</td> <td>250</td> <td>+ 30</td> <td>0</td> <td>0</td> <td>– 30</td> </tr> <tr> <td>250</td> <td>315</td> <td>+ 35</td> <td>0</td> <td>0</td> <td>– 35</td> </tr> <tr> <td>315</td> <td>400</td> <td>+ 40</td> <td>0</td> <td>0</td> <td>– 40</td> </tr> <tr> <td>400</td> <td>500</td> <td>+ 45</td> <td>0</td> <td>–</td> <td>–</td> </tr> </tbody> </table>	Nominal bore diameter $d$ (mm)		$\Delta_{Fw}$ Roller set bore diameter deviation		$\Delta_{Ew}$ Roller set outside diameter deviation		over	up to	upper	lower	upper	lower	–	20	+ 10	0	0	– 10	20	50	+ 15	0	0	– 15	50	120	+ 20	0	0	– 20	120	200	+ 25	0	0	– 25	200	250	+ 30	0	0	– 30	250	315	+ 35	0	0	– 35	315	400	+ 40	0	0	– 40	400	500	+ 45	0	–	–
	Nominal bore diameter $d$ (mm)		$\Delta_{Fw}$ Roller set bore diameter deviation		$\Delta_{Ew}$ Roller set outside diameter deviation																																																								
over	up to	upper	lower	upper	lower																																																								
–	20	+ 10	0	0	– 10																																																								
20	50	+ 15	0	0	– 15																																																								
50	120	+ 20	0	0	– 20																																																								
120	200	+ 25	0	0	– 25																																																								
200	250	+ 30	0	0	– 30																																																								
250	315	+ 35	0	0	– 35																																																								
315	400	+ 40	0	0	– 40																																																								
400	500	+ 45	0	–	–																																																								
[Remark] Interchangeable bearings have an inner ring with rollers that can be matched with the outer ring, or an outer ring with rollers that can be matched with the inner ring, without affecting performance in the bearing that has the same bearing number in one category.																																																													
	Tapered bore tolerance and allowable values of high precision double-row cylindrical roller bearings (classes 5 and 4) are provided in JTEKT standards (refer to Table 7-11 on p. A 70).																																																												
Radial internal clearance	· Cylindrical bore and tapered bore bearings .....(refer to Table 10-8 on pp. A 100, 101.) · Motor bearings.....(refer to Table 10-7 on p. A 99.)																																																												
Recommended fits	Refer to Table 9-4 on pp. A 85, 86.																																																												
Standard cages	<ul style="list-style-type: none"> <li>■ For single-row cylindrical roller bearings : <ul style="list-style-type: none"> <li>· Pressed steel cage (supplementary code : //)</li> <li>· Copper alloy machined cage (supplementary code : FY)</li> </ul> </li> </ul> <p style="margin-left: 100px;">} For application range, refer to Table 1.</p> <p style="margin-left: 100px;">( Copper alloy machined cages without rivets (LY) are also used for some special purposes. )</p> <ul style="list-style-type: none"> <li>■ For double-row cylindrical roller bearings : <ul style="list-style-type: none"> <li>· Prong type copper alloy machined cage (supplementary code : FY)</li> <li>· Separable prong type copper alloy machined cage (supplementary code : FW)</li> </ul> </li> </ul> <p style="margin-left: 100px;">.....for class 5 or higher precision bearings</p>																																																												

Allowable misalignment	Allowable misalignment of single-row cylindrical roller bearings depends on bearing type and specification. General values are as follows : 1) When $P_r/C_r$ is approx. 10% under load of normal use .....0.000 6 rad (2') – 0.000 9 rad (3') 2) When $P_r/C_r$ is approx. 6% under load lighter than 1) .....0.001 2 rad (4') When very large allowable misalignment is required, consult with JTEKT.
Equivalent radial load	Dynamic equivalent radial load $P_r = F_r$ Static equivalent radial load $P_{0r} = F_r$
Allowable axial load	Cylindrical roller bearings with ribs, including loose rib and thrust collar, on both inner and outer rings accommodate axial load to a certain extent. (NJ and NF types accommodate load applied in one direction : NUP and NH in both directions.) For calculation of allowable axial load, refer to p. A 40.

**Table 1 Application of standard cages**

Bearing series	Pressed cage	Machined cage
NU, NUP 10	—	1005 – 1092
NU, NJ, NUP, NF 2	204 – 220	204 – 264
NU, NJ, NUP 2 R	204R – 220R	204R – 240R
NU, NJ, NUP 22	2204 – 2220	2204 – 2252
NU, NJ, NUP 22 R	2204R – 2220R	2204R – 2240R
NU 32	—	3206 – 3252
NU, NJ, NUP, NF 3	304 – 320	304 – 348
NU, NJ, NUP 3 R	304R – 320R	304R – 332R
NU, NJ, NUP 23	2304 – 2320	2304 – 2340
NU, NJ, NUP 23 R	2304R – 2320R	2304R – 2332R
NU 33	—	3306 – 3352
NU, NJ, NUP, NF 4	406 – 420	406 – 430

Single-row cylindrical roller bearings

$d$  20 ~ (30) mm

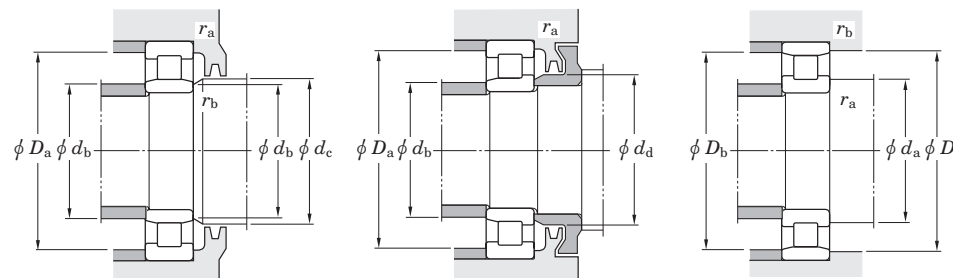
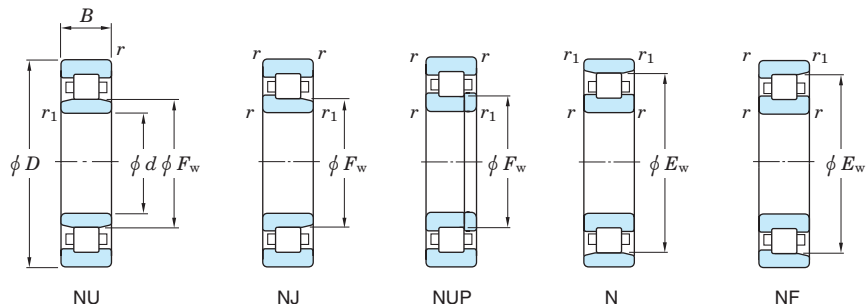

Boundary dimensions (mm)							Basic load ratings (kN)		Limiting speeds (min <sup>-1</sup> )		Bearing No.					Mounting dimensions (mm)							(Refer.)			
$d$	$D$	$B$	$r$ min.	$r_1$ min.	$F_w$	$E_w$	$C_r$	$C_{0r}$	Grease lub.	Oil lub.	NU	NJ	NUP	N	NF	$d_a$ min.	$d_b$ min.	$d_b$ max.	$d_c$ min.	$d_a$ min.	$D_a$ max.	$D_b$ max.	$r_a$ min.	$r_b$ max.	Mass NU (kg)	
20	47	14	1	0.6	27	40	15.4	12.7	15 000	18 000	<b>NU204</b>	<b>NJ204</b>	<b>NUP204</b>	<b>N204</b>	<b>NF204</b>	25	24	26	29	32	42	43	42	1	0.6	0.108
	47	14	1	0.6	26.5	—	25.7	22.6	15 000	18 000	<b>NU204R</b>	<b>NJ204R</b>	<b>NUP204R</b>	—	—	25	24	26	29	32	42	—	—	1	0.6	0.112
	47	18	1	0.6	27	—	20.7	18.4	13 000	18 000	<b>NU2204</b>	<b>NJ2204</b>	<b>NUP2204</b>	—	—	25	24	26	29	32	42	—	—	1	0.6	0.146
	47	18	1	0.6	26.5	—	30.6	28.3	13 000	18 000	<b>NU2204R</b>	<b>NJ2204R</b>	<b>NUP2204R</b>	—	—	25	24	26	29	32	42	—	—	1	0.6	0.146
	52	15	1.1	0.6	28.5	44.5	23.1	19.2	12 000	16 000	<b>NU304</b>	<b>NJ304</b>	<b>NUP304</b>	<b>N304</b>	<b>NF304</b>	26.5	24	27	30	33	45.5	48	45.5	1	0.6	0.147
	52	15	1.1	0.6	27.5	—	31.5	26.9	12 000	16 000	<b>NU304R</b>	<b>NJ304R</b>	<b>NUP304R</b>	—	—	26.5	24	27	30	33	45.5	—	—	1	0.6	0.153
	52	21	1.1	0.6	28.5	—	32.9	30.2	11 000	16 000	<b>NU2304</b>	<b>NJ2304</b>	<b>NUP2304</b>	—	—	26.5	24	27	30	33	45.5	—	—	1	0.6	0.212
	52	21	1.1	0.6	27.5	—	42.0	38.8	11 000	16 000	<b>NU2304R</b>	<b>NJ2304R</b>	<b>NUP2304R</b>	—	—	26.5	24	27	30	33	45.5	—	—	1	1	0.215
25	47	12	0.6	0.3	30.5	—	14.3	13.1	15 000	18 000	<b>NU1005</b>	—	<b>NUP1005</b>	—	—	29	27	30	32	—	43	—	—	0.6	0.3	0.084
	52	15	1	0.6	32	45	17.7	15.7	13 000	16 000	<b>NU205</b>	<b>NJ205</b>	<b>NUP205</b>	<b>N205</b>	<b>NF205</b>	30	29	31	34	37	47	48	47	1	0.6	0.132
	52	15	1	0.6	31.5	—	29.3	27.7	13 000	15 000	<b>NU205R</b>	<b>NJ205R</b>	<b>NUP205R</b>	—	—	30	29	31	34	37	47	—	—	1	0.6	0.138
	52	18	1	0.6	32	—	23.7	22.8	12 000	16 000	<b>NU2205</b>	<b>NJ2205</b>	<b>NUP2205</b>	—	—	30	29	31	34	37	47	—	—	1	0.6	0.163
	52	18	1	0.6	31.5	—	34.9	34.6	12 000	15 000	<b>NU2205R</b>	<b>NJ2205R</b>	<b>NUP2205R</b>	—	—	30	29	31	34	37	47	—	—	1	0.6	0.166
	62	17	1.1	1.1	35	53	29.3	25.2	10 000	14 000	<b>NU305</b>	<b>NJ305</b>	<b>NUP305</b>	<b>N305</b>	<b>NF305</b>	31.5	31.5	33	37	40	55.5	55.5	55	1	1	0.241
	62	17	1.1	1.1	34	—	41.6	37.4	10 000	14 000	<b>NU305R</b>	<b>NJ305R</b>	<b>NUP305R</b>	—	—	31.5	31.5	33	37	40	55.5	—	—	1	1	0.243
	62	24	1.1	1.1	35	—	42.7	40.9	9 100	14 000	<b>NU2305</b>	<b>NJ2305</b>	<b>NUP2305</b>	—	—	31.5	31.5	33	37	40	55.5	—	—	1	1	0.340
62	24	1.1	1.1	34	—	57.0	56.1	9 100	14 000	<b>NU2305R</b>	<b>NJ2305R</b>	<b>NUP2305R</b>	—	—	31.5	31.5	33	37	40	55.5	—	—	1	1	0.350	
30	55	13	1	0.6	36.5	—	18.7	18.4	13 000	15 000	<b>NU1006</b>	—	<b>NUP1006</b>	—	—	35	34	35	38	—	50	—	—	1	0.6	0.121
	62	16	1	0.6	38.5	53.5	23.5	21.5	11 000	13 000	<b>NU206</b>	<b>NJ206</b>	<b>NUP206</b>	<b>N206</b>	<b>NF206</b>	35	34	37	40	44	57	58	56	1	0.6	0.200
	62	16	1	0.6	37.5	—	39.1	37.4	11 000	13 000	<b>NU206R</b>	<b>NJ206R</b>	<b>NUP206R</b>	—	—	35	34	37	40	44	57	—	—	1	0.6	0.209
	62	20	1	0.6	38.5	—	32.9	33.1	9 800	13 000	<b>NU2206</b>	<b>NJ2206</b>	<b>NUP2206</b>	—	—	35	34	37	40	44	57	—	—	1	0.6	0.262
	62	20	1	0.6	37.5	—	48.9	49.8	9 700	13 000	<b>NU2206R</b>	<b>NJ2206R</b>	<b>NUP2206R</b>	—	—	35	34	37	40	44	57	—	—	1	0.6	0.262
	62	23.8	1	1	38.5	—	42.7	46.4	8 700	13 000	<b>NU3206</b>	—	—	—	—	35	35	37	40	—	57	—	—	1	0.6	0.343
	72	19	1.1	1.1	42	62	38.6	35.2	8 700	12 000	<b>NU306</b>	<b>NJ306</b>	<b>NUP306</b>	<b>N306</b>	<b>NF306</b>	36.5	36.5	40	44	48	65.5	65.5	64	1	1	0.358
	72	19	1.1	1.1	40.5	—	53.1	50.2	8 700	12 000	<b>NU306R</b>	<b>NJ306R</b>	<b>NUP306R</b>	—	—	36.5	36.5	40	44	48	65.5	—	—	1	1	0.361
72	27	1.1	1.1	42	—	51.4	50.8	7 700	12 000	<b>NU2306</b>	<b>NJ2306</b>	<b>NUP2306</b>	—	—	36.5	36.5	40	44	48	65.5	—	—	1	1	0.500	
72	27	1.1	1.1	40.5	—	74.6	77.6	7 800	12 000	<b>NU2306R</b>	<b>NJ2306R</b>	<b>NUP2306R</b>	—	—	36.5	36.5	40	44	48	65.5	—	—	1	1	0.534	

[Remarks] 1) Standard cage types used for the above bearings are shown in Table 1 earlier in this section. Please note that basic load ratings and limiting speeds shown above indicate the value applicable to machined cage. Consult JTEKT about bearings with pressed cage, since they may be different from bearings with machined cage in values above.

2) Bearing numbers of NU and NJ type bearings with mounted thrust collar (refer to specification table shown after this specification table) are NUJ and NH.

Single-row cylindrical roller bearings

d (30) ~ (45) mm

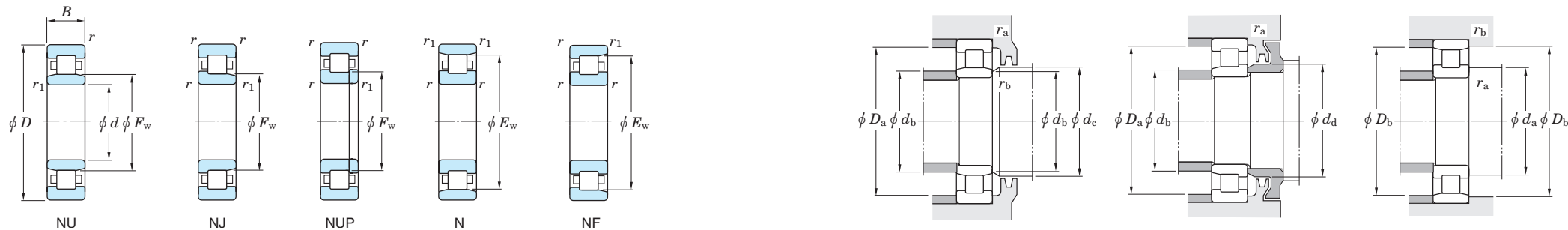

Boundary dimensions (mm)			Basic load ratings (kN)		Limiting speeds (min <sup>-1</sup> )		Bearing No.					Mounting dimensions (mm)							(Refer.)							
d	D	B	r min.	r <sub>1</sub> min.	F <sub>w</sub>	E <sub>w</sub>	C <sub>r</sub>	C <sub>0r</sub>	Grease lub.	Oil lub.	NU	NJ	NUP	N	NF	d <sub>a</sub> min.	d <sub>b</sub> min.	d <sub>b</sub> max.	d <sub>c</sub> min.	d <sub>a</sub> min.	D <sub>a</sub> max.	D <sub>b</sub> max.	r <sub>a</sub> min.	r <sub>b</sub> max.	Mass NU (kg)	
30	72	30.2	1.1	1.1	42	—	69.1	74.3	7 700	12 000	NU3306	—	—	—	—	36.5	36.5	40	44	—	65.5	—	—	1	1	0.650
	90	23	1.5	1.5	45	73	62.8	55.0	7 600	10 000	NU406	NJ406	NUP406	N406	NF406	38	38	44	47	52	82	82	74	1.5	1.5	0.753
35	62	14	1	0.6	42	—	22.6	23.2	11 000	13 000	NU1007	—	NUP1007	—	—	40	39	41	44	—	57	—	—	1	0.5	0.182
	72	17	1.1	0.6	43.8	61.8	33.6	31.5	9 500	11 000	NU207	NJ207	NUP207	N207	NF207	41.5	39	43	46	50	65.5	68	64	1	0.6	0.293
	72	17	1.1	0.6	44	—	50.2	50.2	9 300	11 000	NU207R	NJ207R	NUP207R	—	—	41.5	39	43	46	50	65.5	—	—	1	0.6	0.306
	72	23	1.1	0.6	43.8	—	49.0	51.2	8 500	11 000	NU2207	NJ2207	NUP2207	—	—	41.5	39	43	46	50	65.5	—	—	1	0.6	0.402
	72	23	1.1	0.6	44	—	61.6	65.3	8 300	11 000	NU2207R	NJ2207R	NUP2207R	—	—	41.5	39	43	46	50	65.5	—	—	1	0.6	0.404
	72	27	1.1	1.1	43.8	—	54.8	59.1	7 600	11 000	NU3207	—	—	—	—	41.5	41.5	43	46	—	65.5	—	—	1	0.6	0.524
	80	21	1.5	1.1	46.2	68.2	49.6	46.9	7 900	10 000	NU307	NJ307	NUP307	N307	NF307	43	41.5	45	48	53	72	73.5	71	1.5	1	0.477
	80	21	1.5	1.1	46.2	—	66.6	65.4	7 700	10 000	NU307R	NJ307R	NUP307R	—	—	43	41.5	45	48	53	72	—	—	1.5	1	0.482
	80	31	1.5	1.1	46.2	—	64.4	65.7	7 000	10 000	NU2307	NJ2307	NUP2307	—	—	43	41.5	45	48	53	72	—	—	1.5	1	0.696
	80	31	1.5	1.1	46.2	—	93.1	101	6 900	10 000	NU2307R	NJ2307R	NUP2307R	—	—	43	41.5	45	48	53	72	—	—	1.5	1	0.729
	80	34.9	1.5	1.5	46.2	—	81.7	89.1	7 000	10 000	NU3307	—	—	—	—	43	43	45	48	—	72	—	—	1.5	1	0.908
	100	25	1.5	1.5	53	83	75.2	68.9	6 600	8 800	NU407	NJ407	NUP407	N407	NF407	43	43	52	55	61	92	92	84	1.5	1.5	1.02
40	68	15	1	0.6	47	—	24.9	25.7	10 000	12 000	NU1008	—	NUP1008	—	—	45	44	46	49	—	63	—	—	1	0.6	0.223
	80	18	1.1	1.1	50	70	43.8	42.9	8 300	10 000	NU208	NJ208	NUP208	N208	NF208	46.5	46.5	49	52	56	73.5	73.5	72	1	1	0.366
	80	18	1.1	1.1	49.5	—	55.7	55.4	8 300	9 900	NU208R	NJ208R	NUP208R	—	—	46.5	46.5	49	52	56	73.5	—	—	1	1	0.384
	80	23	1.1	1.1	50	—	58.3	62.0	7 500	10 000	NU2208	NJ2208	NUP2208	—	—	46.5	46.5	49	52	56	73.5	—	—	1	1	0.490
	80	23	1.1	1.1	49.5	—	72.3	77.6	7 400	9 900	NU2208R	NJ2208R	NUP2208R	—	—	46.5	46.5	49	52	56	73.5	—	—	1	1	0.490
	80	30.2	1.1	1.1	50	—	78.3	90.6	6 700	10 000	NU3208	—	—	—	—	46.5	46.5	49	52	—	73.5	—	—	1	1	0.711
	90	23	1.5	1.5	53.5	77.5	58.6	56.9	6 900	9 100	NU308	NJ308	NUP308	N308	NF308	48	48	51	55	60	82	82	80	1.5	1.5	0.657
	90	23	1.5	1.5	52	—	83.1	81.5	6 800	9 100	NU308R	NJ308R	NUP308R	—	—	48	48	51	55	60	82	—	—	1.5	1.5	0.664
	90	33	1.5	1.5	53.5	—	82.2	88.0	6 100	9 100	NU2308	NJ2308	NUP2308	—	—	48	48	51	55	60	82	—	—	1.5	1.5	0.956
	90	33	1.5	1.5	52	—	114	122	6 100	9 100	NU2308R	NJ2308R	NUP2308R	—	—	48	48	51	55	60	82	—	—	1.5	1.5	0.962
	90	36.5	1.5	1.5	53.5	—	104	119	6 100	9 100	NU3308	—	—	—	—	48	48	51	55	—	82	—	—	1.5	1.5	1.19
	110	27	2	2	58	92	97.1	89.1	6 000	8 000	NU408	NJ408	NUP408	N408	NF408	49	49	57	60	67	101	101	93	2	2	1.30
45	75	16	1	0.6	52.5	—	31.0	33.8	9 200	11 000	NU1009	—	NUP1009	—	—	50	49	52	54	—	70	—	—	1	0.6	0.289

[Remarks] 1) Standard cage types used for the above bearings are shown in Table 1 earlier in this section. Please note that basic load ratings and limiting speeds shown above indicate the value applicable to machined cage. Consult JTEKT about bearings with pressed cage, since they may be different from bearings with machined cage in values above.

2) Bearing numbers of NU and NJ type bearings with mounted thrust collar (refer to specification table shown after this specification table) are NUJ and NH.

Single-row cylindrical roller bearings

$d$  (45) ~ (55) mm

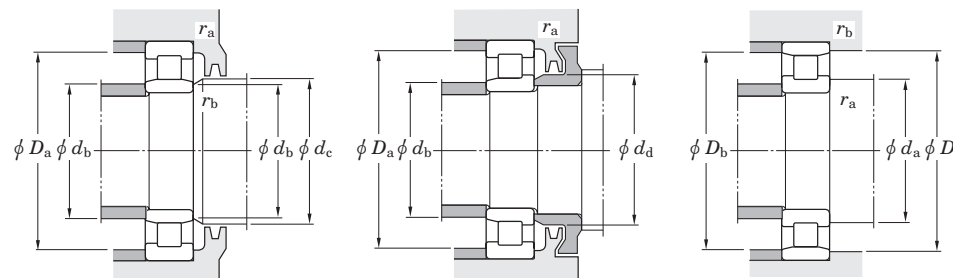
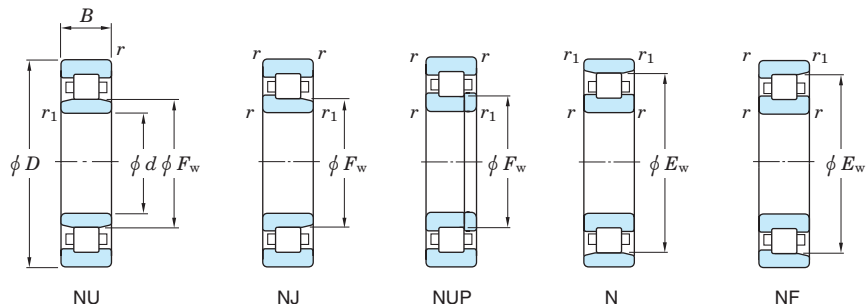

Boundary dimensions (mm)							Basic load ratings (kN)		Limiting speeds (min <sup>-1</sup> )		Bearing No.					Mounting dimensions (mm)								(Refer.)		
$d$	$D$	$B$	$r$ min.	$r_1$ min.	$F_w$	$E_w$	$C_r$	$C_{0r}$	Grease lub.	Oil lub.	NU	NJ	NUP	N	NF	$d_a$ min.	$d_b$ min.	$d_b$ max.	$d_c$ min.	$d_a$ min.	$D_a$ max.	$D_b$ max.	$r_a$ min.	$r_b$ max.	Mass NU (kg)	
45	85	19	1.1	1.1	55	75	46.1	46.9	7 700	9 200	<b>NU209</b>	<b>NJ209</b>	<b>NUP209</b>	<b>N209</b>	<b>NF209</b>	51.5	51.5	54	57	61	78.5	78.5	77	1	1	0.427
	85	19	1.1	1.1	54.5	—	63.1	66.4	7 600	9 200	<b>NU209R</b>	<b>NJ209R</b>	<b>NUP209R</b>	—	—	51.5	51.5	54	57	61	78.5	—	—	1	1	0.439
	85	23	1.1	1.1	55	—	61.4	67.8	6 900	9 200	<b>NU2209</b>	<b>NJ2209</b>	<b>NUP2209</b>	—	—	51.5	51.5	54	57	61	78.5	—	—	1	1	0.536
	85	23	1.1	1.1	54.5	—	76.1	84.6	6 900	9 200	<b>NU2209R</b>	<b>NJ2209R</b>	<b>NUP2209R</b>	—	—	51.5	51.5	54	57	61	78.5	—	—	1	1	0.536
	85	30.2	1.1	1.1	55	—	82.4	99.0	6 100	9 200	<b>NU3209</b>	—	—	—	—	51.5	51.5	54	57	—	78.5	—	—	1	1	0.770
	100	25	1.5	1.5	58.5	86.5	78.8	77.5	6 200	8 300	<b>NU309</b>	<b>NJ309</b>	<b>NUP309</b>	<b>N309</b>	<b>NF309</b>	53	53	57	60	66	92	92	89	1.5	1.5	0.870
	100	25	1.5	1.5	58.5	—	97.4	98.3	6 100	8 200	<b>NU309R</b>	<b>NJ309R</b>	<b>NUP309R</b>	—	—	53	53	57	60	66	92	—	—	1.5	1.5	0.909
	100	36	1.5	1.5	58.5	—	106	113	5 500	8 300	<b>NU2309</b>	<b>NJ2309</b>	<b>NUP2309</b>	—	—	53	53	57	60	66	92	—	—	1.5	1.5	1.25
	100	36	1.5	1.5	58.5	—	137	153	5 400	8 200	<b>NU2309R</b>	<b>NJ2309R</b>	<b>NUP2309R</b>	—	—	53	53	57	60	66	92	—	—	1.5	1.5	1.32
	100	39.7	1.5	1.5	58.5	—	131	149	5 500	8 300	<b>NU3309</b>	—	—	—	—	53	53	57	60	—	92	—	—	1.5	1.5	1.59
	120	29	2	2	64.5	100.5	115	112	5 400	7 200	<b>NU409</b>	<b>NJ409</b>	<b>NUP409</b>	<b>N409</b>	<b>NF409</b>	54	54	63	66	74	111	111	102	2	2	1.64
	50	80	16	1	0.6	57.5	—	33.6	36.8	8 400	9 900	<b>NU1010</b>	—	<b>NUP1010</b>	—	—	55	54	57	59	—	75	—	—	1	0.6
90		20	1.1	1.1	60.4	80.4	48.2	51.0	7 100	8 500	<b>NU210</b>	<b>NJ210</b>	<b>NUP210</b>	<b>N210</b>	<b>NF210</b>	56.5	56.5	58	62	67	83.5	83.5	82	1	1	0.479
90		20	1.1	1.1	59.5	—	66.1	71.9	7 100	8 500	<b>NU210R</b>	<b>NJ210R</b>	<b>NUP210R</b>	—	—	56.5	56.5	58	62	67	83.5	—	—	1	1	0.497
90		23	1.1	1.1	60.4	—	64.2	73.6	6 400	8 500	<b>NU2210</b>	<b>NJ2210</b>	<b>NUP2210</b>	—	—	56.5	56.5	58	62	67	83.5	—	—	1	1	0.580
90		23	1.1	1.1	59.5	—	79.7	91.5	6 400	8 500	<b>NU2210R</b>	<b>NJ2210R</b>	<b>NUP2210R</b>	—	—	56.5	56.5	58	62	67	83.5	—	—	1	1	0.580
90		30.2	1.1	1.1	60.4	—	86.2	108	5 700	8 500	<b>NU3210</b>	—	—	—	—	56.5	56.5	58	62	—	83.5	—	—	1	1	0.829
110		27	2	2	65	95	92.2	93.4	5 600	7 500	<b>NU310</b>	<b>NJ310</b>	<b>NUP310</b>	<b>N310</b>	<b>NF310</b>	59	59	63	67	73	101	101	98	2	2	1.15
110		27	2	2	65	—	110	113	5 500	7 400	<b>NU310R</b>	<b>NJ310R</b>	<b>NUP310R</b>	—	—	59	59	63	67	73	101	—	—	2	2	1.15
110		40	2	2	65	—	128	142	5 000	7 500	<b>NU2310</b>	<b>NJ2310</b>	<b>NUP2310</b>	—	—	59	59	63	67	73	101	—	—	2	2	1.69
110		40	2	2	65	—	163	187	4 900	7 400	<b>NU2310R</b>	<b>NJ2310R</b>	<b>NUP2310R</b>	—	—	59	59	63	67	73	101	—	—	2	2	1.76
110		44.4	2	2	65	—	156	183	5 000	7 500	<b>NU3310</b>	—	—	—	—	59	59	63	67	—	101	—	—	2	2	2.14
130		31	2.1	2.1	70.8	110.8	139	136	4 900	6 600	<b>NU410</b>	<b>NJ410</b>	<b>NUP410</b>	<b>N410</b>	<b>NF410</b>	61	61	69	73	81	119	119	112	2	2	2.01
55	90	18	1.1	1	64.5	—	37.4	43.8	7 600	8 900	<b>NU1011</b>	—	<b>NUP1011</b>	—	—	61.5	60	63	66	—	83.5	—	—	1	1	0.445
	100	21	1.5	1.1	66.5	88.5	58.0	62.3	6 400	7 700	<b>NU211</b>	<b>NJ211</b>	<b>NUP211</b>	<b>N211</b>	<b>NF211</b>	63	61.5	65	68	73	92	93.5	91	1.5	1	0.640
	100	21	1.5	1.1	66	—	86.4	98.7	6 400	7 700	<b>NU211R</b>	<b>NJ211R</b>	<b>NUP211R</b>	—	—	63	61.5	65	68	73	92	—	—	1.5	1	0.650
	100	25	1.5	1.1	66.5	—	75.3	87.2	5 800	7 700	<b>NU2211</b>	<b>NJ2211</b>	<b>NUP2211</b>	—	—	63	61.5	65	68	73	92	—	—	1.5	1	0.780

[Remarks] 1) Standard cage types used for the above bearings are shown in Table 1 earlier in this section. Please note that basic load ratings and limiting speeds shown above indicate the value applicable to machined cage. Consult JTEKT about bearings with pressed cage, since they may be different from bearings with machined cage in values above.

2) Bearing numbers of NU and NJ type bearings with mounted thrust collar (refer to specification table shown after this specification table) are NUJ and NH.

Single-row cylindrical roller bearings

d (55) ~ (65) mm

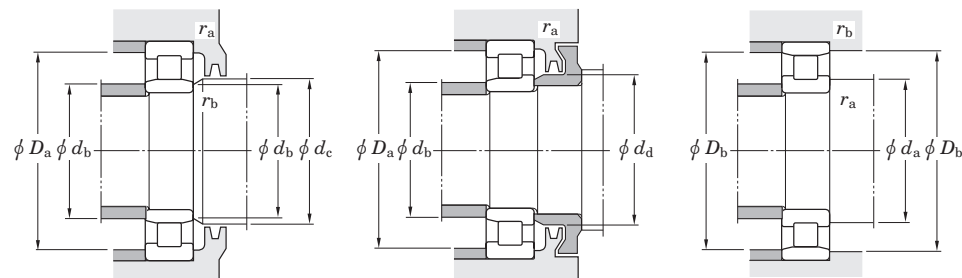
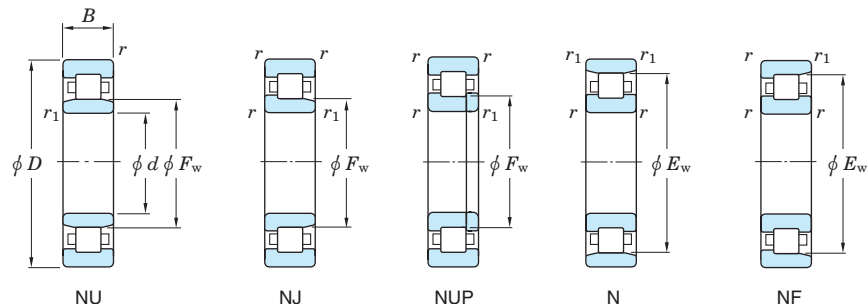

Boundary dimensions (mm)			Basic load ratings (kN)		Limiting speeds (min <sup>-1</sup> )		Bearing No.					Mounting dimensions (mm)							(Refer.)							
d	D	B	r min.	r1 min.	Fw	Ew	Cr	C0r	Grease lub.	Oil lub.	NU	NJ	NUP	N	NF	da min.	db min.	db max.	dc min.	da min.	Da max.	Db max.	ra min.	rb max.	Mass NU (kg)	
55	100	25	1.5	1.1	66	—	101	122	5 800	7 700	<b>NU2211R</b>	<b>NJ2211R</b>	<b>NUP2211R</b>	—	—	63	61.5	65	68	73	92	—	—	1.5	1	0.806
	100	33.3	1.5	1.5	66.5	—	95.5	118	5 100	7 700	<b>NU3211</b>	—	—	—	—	63	63	65	68	—	92	—	—	1.5	1	1.14
	120	29	2	2	70.5	104.5	111	111	5 100	6 800	<b>NU311</b>	<b>NJ311</b>	<b>NUP311</b>	<b>N311</b>	<b>NF311</b>	64	64	69	72	80	111	111	107	2	2	1.44
	120	29	2	2	70.5	—	137	143	5 100	6 700	<b>NU311R</b>	<b>NJ311R</b>	<b>NUP311R</b>	—	—	64	64	69	72	80	111	—	—	2	2	1.50
	120	43	2	2	70.5	—	148	162	4 500	6 800	<b>NU2311</b>	<b>NJ2311</b>	<b>NUP2311</b>	—	—	64	64	69	72	80	111	—	—	2	2	2.10
	120	43	2	2	70.5	—	201	233	4 500	6 700	<b>NU2311R</b>	<b>NJ2311R</b>	<b>NUP2311R</b>	—	—	64	64	69	72	80	111	—	—	2	2	2.25
	120	49.2	2	2	70.5	—	188	220	4 500	6 800	<b>NU3311</b>	—	—	—	—	64	64	69	72	—	111	—	—	2	2	2.81
	140	33	2.1	2.1	77.2	117.2	142	138	4 600	6 100	<b>NU411</b>	<b>NJ411</b>	<b>NUP411</b>	<b>N411</b>	<b>NF411</b>	66	66	76	79	87	129	129	119	2	2	2.51
60	95	18	1.1	1	69.5	—	42.1	50.0	7 000	8 300	<b>NU1012</b>	—	<b>NUP1012</b>	—	—	66.5	65	68	71	—	88.5	—	—	1	1	0.477
	110	22	1.5	1.5	73.5	97.5	71.9	79.9	5 800	7 000	<b>NU212</b>	<b>NJ212</b>	<b>NUP212</b>	<b>N212</b>	<b>NF212</b>	68	68	71	75	80	102	102	100	1.5	1.5	0.823
	110	22	1.5	1.5	72	—	97.7	107	5 800	6 900	<b>NU212R</b>	<b>NJ212R</b>	<b>NUP212R</b>	—	—	68	68	71	75	80	102	—	—	1.5	1.5	0.830
	110	28	1.5	1.5	73.5	—	101	123	5 200	7 000	<b>NU2212</b>	<b>NJ2212</b>	<b>NUP2212</b>	—	—	68	68	71	75	80	102	—	—	1.5	1.5	1.07
	110	28	1.5	1.5	72	—	131	157	5 200	6 900	<b>NU2212R</b>	<b>NJ2212R</b>	<b>NUP2212R</b>	—	—	68	68	71	75	80	102	—	—	1.5	1.5	1.09
	110	36.5	1.5	1.5	73.5	—	128	167	4 700	7 000	<b>NU3212</b>	—	—	—	—	68	68	71	75	—	102	—	—	1.5	1.5	1.52
	130	31	2.1	2.1	77	113	124	126	4 700	6 300	<b>NU312</b>	<b>NJ312</b>	<b>NUP312</b>	<b>N312</b>	<b>NF312</b>	71	71	75	79	86	119	119	116	2	2	1.83
	130	31	2.1	2.1	77	—	150	157	4 600	6 200	<b>NU312R</b>	<b>NJ312R</b>	<b>NUP312R</b>	—	—	71	71	75	79	86	119	—	—	2	2	1.87
	130	46	2.1	2.1	77	—	168	188	4 200	6 300	<b>NU2312</b>	<b>NJ2312</b>	<b>NUP2312</b>	—	—	71	71	75	79	86	119	—	—	2	2	2.69
	130	46	2.1	2.1	77	—	223	262	4 100	6 200	<b>NU2312R</b>	<b>NJ2312R</b>	<b>NUP2312R</b>	—	—	71	71	75	79	86	119	—	—	2	2	2.81
	130	54	2.1	2.1	77	—	220	265	4 200	6 300	<b>NU3312</b>	—	—	—	—	71	71	75	79	—	119	—	—	2	2	3.61
	150	35	2.1	2.1	83	127	178	184	4 200	5 700	<b>NU412</b>	<b>NJ412</b>	<b>NUP412</b>	<b>N412</b>	<b>NF412</b>	71	71	82	85	94	139	139	128	2	2	3.02
65	100	18	1.1	1	74.5	—	43.3	52.9	6 600	7 800	<b>NU1013</b>	—	<b>NUP1013</b>	—	—	71.5	70	73	76	—	93.5	—	—	1	1	0.506
	120	23	1.5	1.5	79.6	105.6	83.8	94.4	5 400	6 400	<b>NU213</b>	<b>NJ213</b>	<b>NUP213</b>	<b>N213</b>	<b>NF213</b>	73	73	77	81	87	112	112	108	1.5	1.5	1.05
	120	23	1.5	1.5	78.5	—	108	119	5 300	6 400	<b>NU213R</b>	<b>NJ213R</b>	<b>NUP213R</b>	—	—	73	73	77	81	87	112	—	—	1.5	1.5	1.05
	120	31	1.5	1.5	79.6	—	120	149	4 800	6 400	<b>NU2213</b>	<b>NJ2213</b>	<b>NUP2213</b>	—	—	73	73	77	81	87	112	—	—	1.5	1.5	1.43
	120	31	1.5	1.5	78.5	—	149	181	4 800	6 400	<b>NU2213R</b>	<b>NJ2213R</b>	<b>NUP2213R</b>	—	—	73	73	77	81	87	112	—	—	1.5	1.5	1.45
	120	38.1	1.5	1.5	79.6	—	148	197	4 300	6 400	<b>NU3213</b>	—	—	—	—	73	73	77	81	—	112	—	—	1.5	1.5	1.90
	140	33	2.1	2.1	83.5	121.5	137	139	4 300	5 800	<b>NU313</b>	<b>NJ313</b>	<b>NUP313</b>	<b>N313</b>	<b>NF313</b>	76	76	81	85	93	129	129	125	2	2	2.24

[Remarks] 1) Standard cage types used for the above bearings are shown in Table 1 earlier in this section. Please note that basic load ratings and limiting speeds shown above indicate the value applicable to machined cage. Consult JTEKT about bearings with pressed cage, since they may be different from bearings with machined cage in values above.

2) Bearing numbers of NU and NJ type bearings with mounted thrust collar (refer to specification table shown after this specification table) are NUJ and NH.

Single-row cylindrical roller bearings

$d$  (65) ~ (75) mm

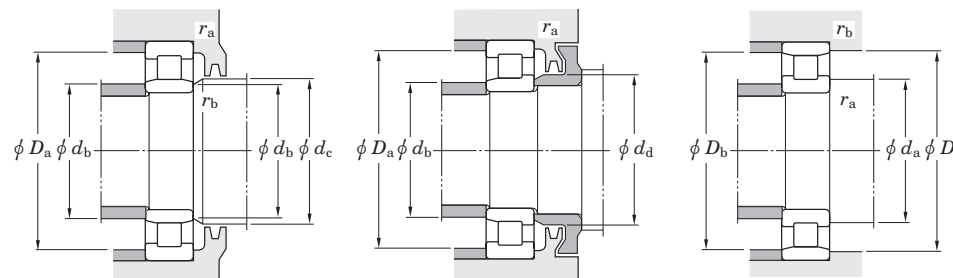
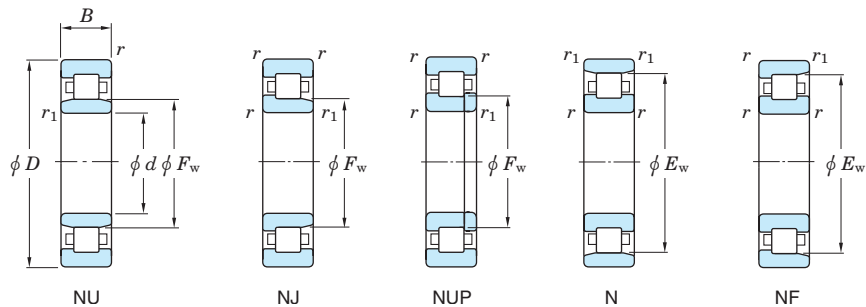

Boundary dimensions (mm)			Basic load ratings (kN)		Limiting speeds (min <sup>-1</sup> )		Bearing No.					Mounting dimensions (mm)							(Refer.)							
$d$	$D$	$B$	$r$ min.	$r_1$ min.	$F_w$	$E_w$	$C_r$	$C_{0r}$	Grease lub.	Oil lub.	NU	NJ	NUP	N	NF	$d_a$ min.	$d_b$ min.	$d_b$ max.	$d_c$ min.	$d_a$ min.	$D_a$ max.	$D_b$ max.	$r_a$ min.	$r_b$ max.	Mass NU (kg)	
65	140	33	2.1	2.1	82.5	—	181	191	4 300	5 700	<b>NU313R</b>	<b>NJ313R</b>	<b>NUP313R</b>	—	—	76	76	81	85	93	129	—	—	2	2	2.31
	140	48	2.1	2.1	83.5	—	190	212	3 900	5 800	<b>NU2313</b>	<b>NJ2313</b>	<b>NUP2313</b>	—	—	76	76	81	85	93	129	—	—	2	2	3.25
	140	48	2.1	2.1	82.5	—	251	287	3 800	5 700	<b>NU2313R</b>	<b>NJ2313R</b>	<b>NUP2313R</b>	—	—	76	76	81	85	93	129	—	—	2	2	3.36
	140	58.7	2.1	2.1	83.5	—	241	294	3 900	5 800	<b>NU3313</b>	—	—	—	—	76	76	81	85	—	129	—	—	2	2	4.53
	160	37	2.1	2.1	89.3	135.3	198	203	4 000	5 300	<b>NU413</b>	<b>NJ413</b>	<b>NUP413</b>	<b>N413</b>	<b>NF413</b>	76	76	88	91	100	149	149	137	2	2	3.58
70	110	20	1.1	1	80	—	57.9	70.4	6 100	7 200	<b>NU1014</b>	—	<b>NUP1014</b>	—	—	76.5	75	78	82	—	103.5	—	—	1	1	0.702
	125	24	1.5	1.5	84.5	110.5	83.3	95.2	5 100	6 100	<b>NU214</b>	<b>NJ214</b>	<b>NUP214</b>	<b>N214</b>	<b>NF214</b>	78	78	82	86	92	117	117	114	1.5	1.5	1.15
	125	24	1.5	1.5	83.5	—	119	137	5 000	6 000	<b>NU214R</b>	<b>NJ214R</b>	<b>NUP214R</b>	—	—	78	78	82	86	92	117	—	—	1.5	1.5	1.16
	125	31	1.5	1.5	84.5	—	119	151	4 600	6 100	<b>NU2214</b>	<b>NJ2214</b>	<b>NUP2214</b>	—	—	78	78	82	86	92	117	—	—	1.5	1.5	1.52
	125	31	1.5	1.5	83.5	—	156	194	4 500	6 000	<b>NU2214R</b>	<b>NJ2214R</b>	<b>NUP2214R</b>	—	—	78	78	82	86	92	117	—	—	1.5	1.5	1.53
	125	39.7	1.5	1.5	84.5	—	147	198	4 100	6 100	<b>NU3214</b>	—	—	—	—	78	78	82	86	—	117	—	—	1.5	1.5	2.09
	150	35	2.1	2.1	90	130	162	168	4 000	5 400	<b>NU314</b>	<b>NJ314</b>	<b>NUP314</b>	<b>N314</b>	<b>NF314</b>	81	81	87	92	100	139	139	134	2	2	2.73
	150	35	2.1	2.1	89	—	205	222	4 000	5 300	<b>NU314R</b>	<b>NJ314R</b>	<b>NUP314R</b>	—	—	81	81	87	92	100	139	—	—	2	2	2.81
	150	51	2.1	2.1	90	—	224	262	3 600	5 400	<b>NU2314</b>	<b>NJ2314</b>	<b>NUP2314</b>	—	—	81	81	87	92	100	139	—	—	2	2	3.97
	150	51	2.1	2.1	89	—	275	323	3 600	5 300	<b>NU2314R</b>	<b>NJ2314R</b>	<b>NUP2314R</b>	—	—	81	81	87	92	100	139	—	—	2	2	4.08
	150	63.5	2.1	2.1	90	—	283	356	3 600	5 400	<b>NU3314</b>	—	—	—	—	81	81	87	92	—	139	—	—	2	2	5.62
	180	42	3	3	100	152	246	257	3 500	4 700	<b>NU414</b>	<b>NJ414</b>	<b>NUP414</b>	<b>N414</b>	<b>NF414</b>	83	83	99	102	112	167	167	153	2.5	2.5	5.26
75	115	20	1.1	1	85	—	63.6	78.1	5 700	6 800	<b>NU1015</b>	—	<b>NUP1015</b>	—	—	81.5	80	83	87	—	108.5	—	—	1	1	0.735
	130	25	1.5	1.5	88.5	116.5	101	118	4 800	5 800	<b>NU215</b>	<b>NJ215</b>	<b>NUP215</b>	<b>N215</b>	<b>NF215</b>	83	83	87	90	96	122	122	120	1.5	1.5	1.24
	130	25	1.5	1.5	88.5	—	130	156	4 800	5 700	<b>NU215R</b>	<b>NJ215R</b>	<b>NUP215R</b>	—	—	83	83	87	90	96	122	—	—	1.5	1.5	1.29
	130	31	1.5	1.5	88.5	—	135	172	4 300	5 800	<b>NU2215</b>	<b>NJ2215</b>	<b>NUP2215</b>	—	—	83	83	87	90	96	122	—	—	1.5	1.5	1.57
	130	31	1.5	1.5	88.5	—	162	207	4 300	5 700	<b>NU2215R</b>	<b>NJ2215R</b>	<b>NUP2215R</b>	—	—	83	83	87	90	96	122	—	—	1.5	1.5	1.61
	130	41.3	1.5	1.5	88.5	—	167	226	3 900	5 800	<b>NU3215</b>	—	—	—	—	83	83	87	90	—	122	—	—	1.5	1.5	2.28
	160	37	2.1	2.1	95.5	139.5	194	205	3 800	5 000	<b>NU315</b>	<b>NJ315</b>	<b>NUP315</b>	<b>N315</b>	<b>NF315</b>	86	86	93	97	106	149	149	143	2	2	3.24
	160	37	2.1	2.1	95	—	240	263	3 700	5 000	<b>NU315R</b>	<b>NJ315R</b>	<b>NUP315R</b>	—	—	86	86	93	97	106	149	—	—	2	2	3.37
	160	55	2.1	2.1	95.5	—	275	327	3 400	5 000	<b>NU2315</b>	<b>NJ2315</b>	<b>NUP2315</b>	—	—	86	86	93	97	106	149	—	—	2	2	4.84
	160	55	2.1	2.1	95	—	329	395	3 300	5 000	<b>NU2315R</b>	<b>NJ2315R</b>	<b>NUP2315R</b>	—	—	86	86	93	97	106	149	—	—	2	2	5.00

[Remarks] 1) Standard cage types used for the above bearings are shown in Table 1 earlier in this section. Please note that basic load ratings and limiting speeds shown above indicate the value applicable to machined cage. Consult JTEKT about bearings with pressed cage, since they may be different from bearings with machined cage in values above.

2) Bearing numbers of NU and NJ type bearings with mounted thrust collar (refer to specification table shown after this specification table) are NUJ and NH.



Single-row cylindrical roller bearings

d (75) ~ (90) mm

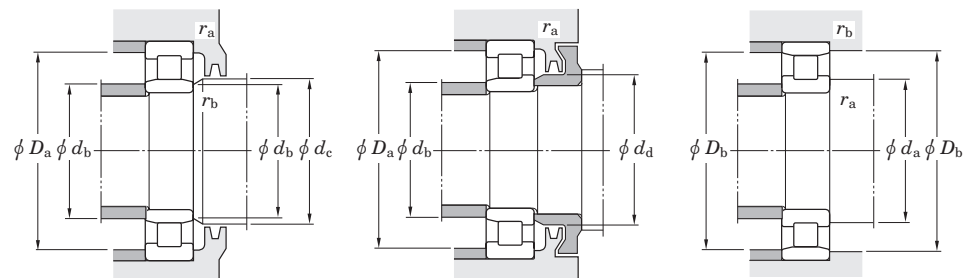
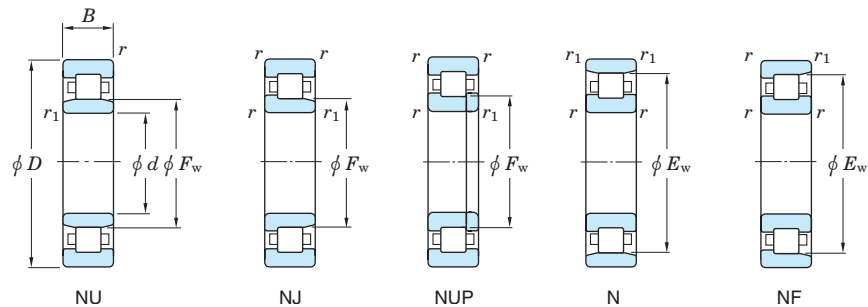

Boundary dimensions (mm)			Basic load ratings (kN)		Limiting speeds (min <sup>-1</sup> )		Bearing No.					Mounting dimensions (mm)								(Refer.)						
d	D	B	r min.	r <sub>1</sub> min.	F <sub>w</sub>	E <sub>w</sub>	C <sub>r</sub>	C <sub>0r</sub>	Grease lub.	Oil lub.	NU	NJ	NUP	N	NF	d <sub>a</sub> min.	d <sub>b</sub> min.	d <sub>b</sub> max.	d <sub>c</sub> min.	d <sub>a</sub> min.	D <sub>a</sub> max.	D <sub>b</sub> max.	r <sub>a</sub> min.	r <sub>b</sub> max.	Mass NU (kg)	
75	160	68.3	2.1	2.1	95.5	—	338	430	3 400	5 000	NU3315	—	—	—	—	86	86	93	97	—	149	—	—	2	2	6.86
	190	45	3	3	104.5	160.5	265	274	3 300	4 400	NU415	NJ415	NUP415	N415	NF415	88	88	103	107	118	177	177	162	2.5	2.5	6.25
80	125	22	1.1	1	91.5	—	69.3	86.4	5 300	6 300	NU1016	—	NUP1016	—	—	86.5	85	90	94	—	118.5	—	—	1	1	0.994
	140	26	2	2	95.3	125.3	106	122	4 500	5 400	NU216	NJ216	NUP216	N216	NF216	89	89	94	97	104	131	131	128	2	2	1.51
	140	26	2	2	95.3	—	139	167	4 400	5 300	NU216R	NJ216R	NUP216R	—	—	89	89	94	97	104	131	—	—	2	2	1.56
	140	33	2	2	95.3	—	148	186	4 000	5 400	NU2216	NJ2216	NUP2216	—	—	89	89	94	97	104	131	—	—	2	2	1.96
	140	33	2	2	95.3	—	186	243	4 000	5 300	NU2216R	NJ2216R	NUP2216R	—	—	89	89	94	97	104	131	—	—	2	2	2.03
	140	44.4	2	2	95.3	—	190	259	3 600	5 400	NU3216	—	—	—	—	89	89	94	97	—	131	—	—	2	2	2.87
	170	39	2.1	2.1	103	147	194	207	3 500	4 700	NU316	NJ316	NUP316	N316	NF316	91	91	99	105	114	159	159	151	2	2	3.92
	170	39	2.1	2.1	101	—	259	282	3 500	4 700	NU316R	NJ316R	NUP316R	—	—	91	91	99	105	114	159	—	—	2	2	4.00
	170	58	2.1	2.1	103	—	275	332	3 100	4 700	NU2316	NJ2316	NUP2316	—	—	91	91	99	105	114	159	—	—	2	2	5.83
	170	58	2.1	2.1	101	—	361	431	3 100	4 700	NU2316R	NJ2316R	NUP2316R	—	—	91	91	99	105	114	159	—	—	2	2	5.95
	170	68.3	2.1	2.1	103	—	338	436	3 100	4 700	NU3316	—	—	—	—	91	91	99	105	—	159	—	—	2	2	7.72
	200	48	3	3	110	170	302	315	3 100	4 200	NU416	NJ416	NUP416	N416	NF416	93	93	109	112	124	187	187	172	2.5	2.5	7.28
85	130	22	1.1	1	96.5	—	71.4	91.2	5 100	6 000	NU1017	—	NUP1017	—	—	91.5	90	95	99	—	123.5	—	—	1	1	1.04
	150	28	2	2	101.8	133.8	121	140	4 200	5 000	NU217	NJ217	NUP217	N217	NF217	94	94	99	104	110	141	141	137	2	2	1.90
	150	28	2	2	100.5	—	167	199	4 200	5 000	NU217R	NJ217R	NUP217R	—	—	94	94	99	104	110	141	—	—	2	2	1.94
	150	36	2	2	101.8	—	169	218	3 800	5 000	NU2217	NJ2217	NUP2217	—	—	94	94	99	104	110	141	—	—	2	2	2.50
	150	36	2	2	100.5	—	218	279	3 700	5 000	NU2217R	NJ2217R	NUP2217R	—	—	94	94	99	104	110	141	—	—	2	2	2.53
	150	49.2	2	2	101.8	—	215	296	3 300	5 000	NU3217	—	—	—	—	94	94	99	104	—	141	—	—	2	2	3.67
	180	41	3	3	108	156	225	247	3 300	4 500	NU317	NJ317	NUP317	N317	NF317	98	98	106	110	119	167	167	160	2.5	2.5	4.52
	180	41	3	3	108	—	291	330	3 300	4 400	NU317R	NJ317R	NUP317R	—	—	98	98	106	110	119	167	—	—	2.5	2.5	4.80
	180	60	3	3	108	—	315	382	3 000	4 500	NU2317	NJ2317	NUP2317	—	—	98	98	106	110	119	167	—	—	2.5	2.5	6.62
	180	60	3	3	108	—	394	485	2 900	4 400	NU2317R	NJ2317R	NUP2317R	—	—	98	98	106	110	119	167	—	—	2.5	2.5	6.98
	180	73	3	3	108	—	399	517	3 000	4 500	NU3317	—	—	—	—	98	98	106	110	—	167	—	—	2.5	2.5	9.23
	210	52	4	4	113	177	340	350	3 000	4 000	NU417	NJ417	NUP417	N417	NF417	101	101	111	115	128	194	194	179	3	3	8.68
90	140	24	1.5	1.1	103	—	84.7	109	4 700	5 600	NU1018	—	NUP1018	—	—	98	96.5	101	106	—	132	—	—	1.5	1	1.34

[Remarks] 1) Standard cage types used for the above bearings are shown in Table 1 earlier in this section. Please note that basic load ratings and limiting speeds shown above indicate the value applicable to machined cage. Consult JTEKT about bearings with pressed cage, since they may be different from bearings with machined cage in values above.

2) Bearing numbers of NU and NJ type bearings with mounted thrust collar (refer to specification table shown after this specification table) are NUJ and NH.



Single-row cylindrical roller bearings

d (90) ~ (100) mm

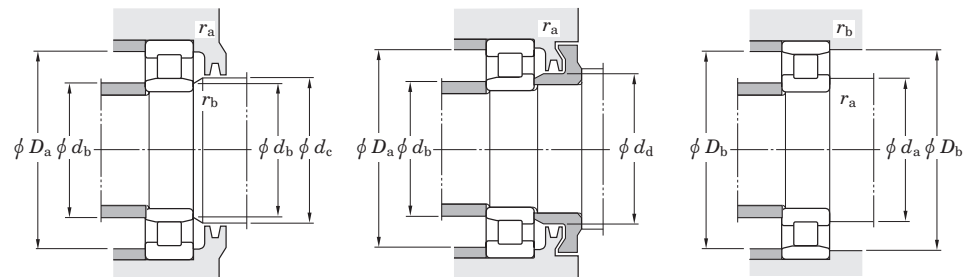
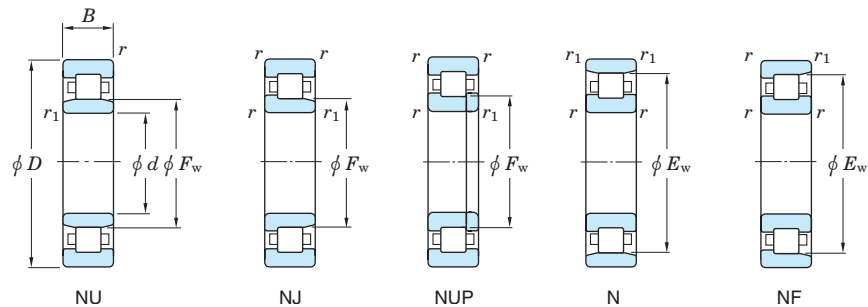

d	Boundary dimensions (mm)						Basic load ratings (kN)		Limiting speeds (min <sup>-1</sup> )		Bearing No.					Mounting dimensions (mm)								Mass (kg)			
	D	B	r <sub>min.</sub>	r <sub>1 min.</sub>	F <sub>w</sub>	E <sub>w</sub>	C <sub>r</sub>	C <sub>0r</sub>	Grease lub.	Oil lub.	NU	NJ	NUP	N	NF	d <sub>a min.</sub>	d <sub>b min.</sub>	d <sub>b max.</sub>	d <sub>c min.</sub>	d <sub>a min.</sub>	D <sub>a max.</sub>	D <sub>b max.</sub>	D <sub>b min.</sub>		r <sub>a max.</sub>	r <sub>b max.</sub>	(Refer.)
90	160	30	2	2	107	143	152	178	3 900	4 700	<b>NU218</b>	<b>NJ218</b>	<b>NUP218</b>	<b>N218</b>	<b>NF218</b>	99	99	105	109	116	151	151	146	2	2	2.28	
	160	30	2	2	107	—	182	217	3 900	4 700	<b>NU218R</b>	<b>NJ218R</b>	<b>NUP218R</b>	—	—	99	99	105	109	116	151	—	—	2	2	2.38	
	160	40	2	2	107	—	207	265	3 500	4 700	<b>NU2218</b>	<b>NJ2218</b>	<b>NUP2218</b>	—	—	99	99	105	109	116	151	—	—	2	2	3.10	
	160	40	2	2	107	—	242	314	3 500	4 700	<b>NU2218R</b>	<b>NJ2218R</b>	<b>NUP2218R</b>	—	—	99	99	105	109	116	151	—	—	2	2	3.21	
	160	52.4	2	2	107	—	270	373	3 100	4 700	<b>NU3218</b>	—	—	—	—	99	99	105	109	—	151	—	—	2	2	4.49	
	190	43	3	3	115	165	243	265	3 100	4 200	<b>NU318</b>	<b>NJ318</b>	<b>NUP318</b>	<b>N318</b>	<b>NF318</b>	103	103	111	117	127	177	177	169	2.5	2.5	5.38	
	190	43	3	3	113.5	—	316	355	3 100	4 100	<b>NU318R</b>	<b>NJ318R</b>	<b>NUP318R</b>	—	—	103	103	111	117	127	177	—	—	2.5	2.5	5.47	
	190	64	3	3	115	—	329	395	2 800	4 200	<b>NU2318</b>	<b>NJ2318</b>	<b>NUP2318</b>	—	—	103	103	111	117	127	177	—	—	2.5	2.5	7.90	
	190	64	3	3	113.5	—	437	534	2 800	4 100	<b>NU2318R</b>	<b>NJ2318R</b>	<b>NUP2318R</b>	—	—	103	103	111	117	127	177	—	—	2.5	2.5	8.12	
	190	73	3	3	115	—	428	559	2 800	4 200	<b>NU3318</b>	—	—	—	—	103	103	111	117	—	177	—	—	2.5	2.5	10.3	
	225	54	4	4	123.5	191.5	374	400	2 800	3 700	<b>NU418</b>	<b>NJ418</b>	<b>NUP418</b>	<b>N418</b>	<b>NF418</b>	106	106	122	125	139	209	209	194	3	3	10.3	
	95	145	24	1.5	1.1	108	—	87.2	115	4 500	5 300	<b>NU1019</b>	—	<b>NUP1019</b>	—	—	103	101.5	106	111	—	137	—	—	1.5	1	1.40
		170	32	2.1	2.1	113.5	151.5	165	195	3 700	4 400	<b>NU219</b>	<b>NJ219</b>	<b>NUP219</b>	<b>N219</b>	<b>NF219</b>	106	106	111	116	123	159	159	155	2	2	2.80
170		32	2.1	2.1	112.5	—	221	265	3 700	4 400	<b>NU219R</b>	<b>NJ219R</b>	<b>NUP219R</b>	—	—	106	106	111	116	123	159	—	—	2	2	2.92	
170		43	2.1	2.1	113.5	—	230	298	3 300	4 400	<b>NU2219</b>	<b>NJ2219</b>	<b>NUP2219</b>	—	—	106	106	111	116	123	159	—	—	2	2	3.85	
170		43	2.1	2.1	112.5	—	287	371	3 300	4 400	<b>NU2219R</b>	<b>NJ2219R</b>	<b>NUP2219R</b>	—	—	106	106	111	116	123	159	—	—	2	2	3.93	
170		55.6	2.1	2.1	113.5	—	297	412	3 000	4 400	<b>NU3219</b>	—	—	—	—	106	106	111	116	—	159	—	—	2	2	5.42	
200		45	3	3	121.5	173.5	277	311	3 000	4 000	<b>NU319</b>	<b>NJ319</b>	<b>NUP319</b>	<b>N319</b>	<b>NF319</b>	108	108	119	124	134	187	187	178	2.5	2.5	6.20	
200		45	3	3	121.5	—	334	387	2 900	3 900	<b>NU319R</b>	<b>NJ319R</b>	<b>NUP319R</b>	—	—	108	108	119	124	134	187	—	—	2.5	2.5	6.42	
200		67	3	3	121.5	—	394	496	2 600	4 000	<b>NU2319</b>	<b>NJ2319</b>	<b>NUP2319</b>	—	—	108	108	119	124	134	187	—	—	2.5	2.5	9.39	
200		77.8	3	3	121.5	—	487	654	2 600	4 000	<b>NU3319</b>	—	—	—	—	108	108	119	124	—	187	—	—	2.5	2.5	12.1	
240		55	4	4	133.5	201.5	410	444	2 600	3 400	<b>NU419</b>	<b>NJ419</b>	<b>NUP419</b>	<b>N419</b>	<b>NF419</b>	111	111	132	136	149	224	224	204	3	3	13.6	
100		150	24	1.5	1.1	113	—	91.0	120	4 300	5 100	<b>NU1020</b>	—	<b>NUP1020</b>	—	—	108	106.5	111	116	—	142	—	—	1.5	1	1.46
		180	34	2.1	2.1	120	160	183	217	3 500	4 200	<b>NU220</b>	<b>NJ220</b>	<b>NUP220</b>	<b>N220</b>	<b>NF220</b>	111	111	117	122	130	169	169	164	2	2	3.38
	180	34	2.1	2.1	119	—	250	306	3 500	4 200	<b>NU220R</b>	<b>NJ220R</b>	<b>NUP220R</b>	—	—	111	111	117	122	130	169	—	—	2	2	3.52	
	180	46	2.1	2.1	120	—	259	338	3 100	4 200	<b>NU2220</b>	<b>NJ2220</b>	<b>NUP2220</b>	—	—	111	111	117	122	130	169	—	—	2	2	4.67	
	180	46	2.1	2.1	119	—	334	444	3 100	4 200	<b>NU2220R</b>	<b>NJ2220R</b>	<b>NUP2220R</b>	—	—	111	111	117	122	130	169	—	—	2	2	4.82	

[Remarks] 1) Standard cage types used for the above bearings are shown in Table 1 earlier in this section. Please note that basic load ratings and limiting speeds shown above indicate the value applicable to machined cage. Consult JTEKT about bearings with pressed cage, since they may be different from bearings with machined cage in values above.

2) Bearing numbers of NU and NJ type bearings with mounted thrust collar (refer to specification table shown after this specification table) are NUJ and NH.

Single-row cylindrical roller bearings

$d$  (100) ~ 110 mm

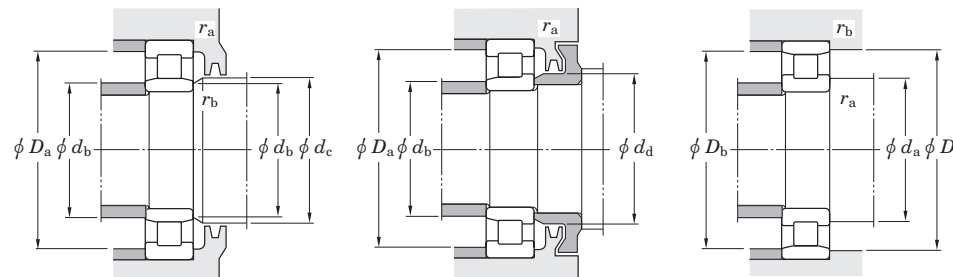
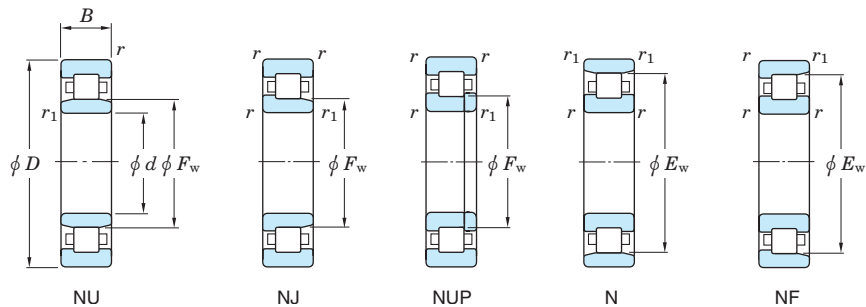

Boundary dimensions (mm)			Basic load ratings (kN)		Limiting speeds (min <sup>-1</sup> )		Bearing No.					Mounting dimensions (mm)								(Refer.)						
$d$	$D$	$B$	$r$ min.	$r_1$ min.	$F_w$	$E_w$	$C_r$	$C_{0r}$	Grease lub.	Oil lub.	NU	NJ	NUP	N	NF	$d_a$ min.	$d_b$ min.	$d_b$ max.	$d_c$ min.	$d_a$ min.	$D_a$ max.	$D_b$ max.	$r_a$ min.	$r_b$ max.	Mass NU (kg)	
100	180	60.3	2.1	2.1	120	—	327	459	2 800	4 200	NU3220	—	—	—	—	111	111	117	122	—	169	—	—	2	2	6.62
	215	47	3	3	129.5	185.5	323	337	2 800	3 700	NU320	NJ320	NUP320	N320	NF320	113	113	125	132	143	202	202	190	2.5	2.5	7.70
	215	47	3	3	127.5	—	379	424	2 700	3 600	NU320R	NJ320R	NUP320R	—	—	113	113	125	132	143	202	—	—	2.5	2.5	7.75
	215	73	3	3	129.5	—	464	548	2 500	3 700	NU2320	NJ2320	NUP2320	—	—	113	113	125	132	143	202	—	—	2.5	2.5	11.9
	215	73	3	3	127.5	—	570	717	2 400	3 600	NU2320R	NJ2320R	NUP2320R	—	—	113	113	125	132	143	202	—	—	2.5	2.5	12.1
	215	82.6	3	3	129.5	—	530	706	2 500	3 700	NU3320	—	—	—	—	113	113	125	132	—	202	—	—	2.5	2.5	15.0
	250	58	4	4	139	211	458	498	2 500	3 300	NU420	NJ420	NUP420	N420	NF420	116	116	137	141	156	234	234	213	3	3	14.0
105	160	26	2	1.1	119.5	—	108	149	4 100	4 800	NU1021	—	NUP1021	—	—	114	111.5	118	122	—	151	—	—	2	1	1.85
	190	36	2.1	2.1	126.8	168.8	201	241	3 300	3 900	NU221	NJ221	NUP221	N221	NF221	116	116	124	129	137	179	179	173	2	2	4.00
	190	65.1	2.1	2.1	126.8	—	344	482	2 600	3 900	NU3221	—	—	—	—	116	116	124	129	—	179	—	—	2	2	8.00
	225	49	3	3	135	195	366	417	2 600	3 500	NU321	NJ321	NUP321	N321	NF321	118	118	132	137	149	212	212	199	2.5	2.5	8.76
	225	77	3	3	135	—	568	750	2 300	3 500	NU2321	—	NUP2321	—	—	118	118	131	138	—	212	—	—	2.5	2.5	15.6
	225	87.3	3	3	135	—	638	871	2 300	3 500	NU3321	—	—	—	—	118	118	132	137	—	212	—	—	2.5	2.5	17.4
	260	60	4	4	144.5	220.5	471	510	2 400	3 100	NU421	NJ421	NUP421	N421	NF421	121	121	143	147	162	244	244	223	3	3	19.1
110	170	28	2	1.1	125	—	134	171	3 800	4 500	NU1022	—	NUP1022	—	—	119	116.5	124	128	—	161	—	—	2	1	2.31
	200	38	2.1	2.1	132.5	178.5	241	290	3 100	3 700	NU222	NJ222	NUP222	N222	NF222	121	121	130	135	144	189	189	182	2	2	4.65
	200	38	2.1	2.1	132.5	—	293	365	3 100	3 700	NU222R	NJ222R	NUP222R	—	—	121	121	130	135	144	189	—	—	2	2	4.90
	200	53	2.1	2.1	132.5	—	334	442	2 800	3 700	NU2222	NJ2222	NUP2222	—	—	121	121	130	135	144	189	—	—	2	2	6.93
	200	53	2.1	2.1	132.5	—	384	517	2 800	3 700	NU2222R	NJ2222R	NUP2222R	—	—	121	121	130	135	144	189	—	—	2	2	6.93
	200	69.8	2.1	2.1	132.5	—	427	607	2 500	3 700	NU3222	—	—	—	—	121	121	130	135	—	189	—	—	2	2	9.55
	240	50	3	3	143	207	411	467	2 500	3 300	NU322	NJ322	NUP322	N322	NF322	123	123	140	145	158	227	227	211	2.5	2.5	10.4
	240	50	3	3	143	—	451	525	2 400	3 200	NU322R	NJ322R	NUP322R	—	—	123	123	140	145	158	227	—	—	2.5	2.5	10.7
	240	80	3	3	143	—	604	789	2 200	3 300	NU2322	NJ2322	NUP2322	—	—	123	123	140	145	158	227	—	—	2.5	2.5	18.8
	240	80	3	3	143	—	680	880	2 200	3 200	NU2322R	NJ2322R	NUP2322R	—	—	123	123	140	145	158	227	—	—	2.5	2.5	18.8
	240	92.1	3	3	143	—	678	918	2 200	3 300	NU3322	—	—	—	—	123	123	140	145	—	227	—	—	2.5	2.5	21.1
	280	65	4	4	155	235	550	621	2 200	2 900	NU422	NJ422	NUP422	N422	NF422	126	126	153	157	173	264	264	237	3	3	19.9

[Remarks] 1) Standard cage types used for the above bearings are shown in Table 1 earlier in this section. Please note that basic load ratings and limiting speeds shown above indicate the value applicable to machined cage. Consult JTEKT about bearings with pressed cage, since they may be different from bearings with machined cage in values above.

2) Bearing numbers of NU and NJ type bearings with mounted thrust collar (refer to specification table shown after this specification table) are NUJ and NH.

Single-row cylindrical roller bearings

d 120 ~ (140) mm

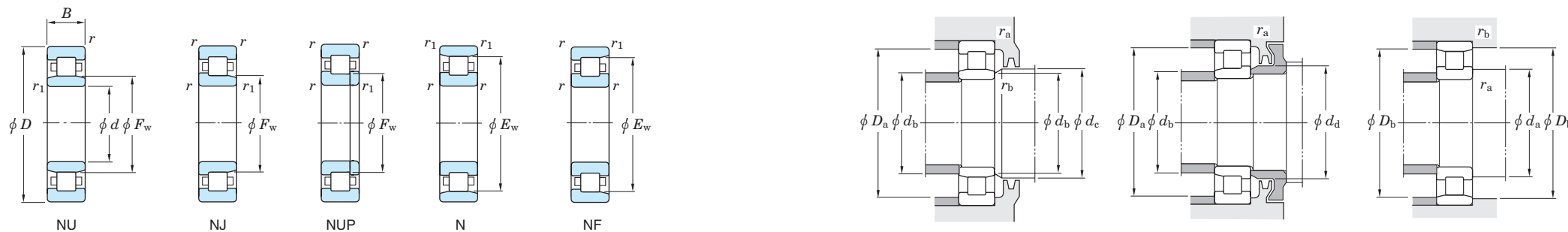

Boundary dimensions (mm)							Basic load ratings (kN)		Limiting speeds (min <sup>-1</sup> )		Bearing No.					Mounting dimensions (mm)								(Refer.)		
d	D	B	r	r <sub>1</sub>	F <sub>w</sub>	E <sub>w</sub>	C <sub>r</sub>	C <sub>0r</sub>	Grease lub.	Oil lub.	NU	NJ	NUP	N	NF	d <sub>a</sub>	d <sub>b</sub>	d <sub>c</sub>	d <sub>a</sub>	D <sub>a</sub>	D <sub>b</sub>	r <sub>a</sub>	r <sub>b</sub>	Mass NU (kg)		
			min.	min.												min.	min.	max.	min.	min.	max.	max.	min.	max.		
120	180	28	2	1.1	135	—	137	181	3 500	4 200	NU1024	—	NUP1024	—	—	129	126.5	134	138	—	171	—	—	2	1	2.47
	215	40	2.1	2.1	143.5	191.5	260	318	2 900	3 400	NU224	NJ224	NUP224	N224	NF224	131	131	141	146	156	204	204	196	2	2	5.65
	215	40	2.1	2.1	143.5	—	336	421	2 800	3 400	NU224R	NJ224R	NUP224R	—	—	131	131	141	146	156	204	—	—	2	2	5.85
	215	58	2.1	2.1	143.5	—	367	492	2 600	3 400	NU2224	NJ2224	NUP2224	—	—	131	131	141	146	156	204	—	—	2	2	8.56
	215	58	2.1	2.1	143.5	—	452	619	2 600	3 400	NU2224R	NJ2224R	NUP2224R	—	—	131	131	141	146	156	204	—	—	2	2	8.56
	215	76	2.1	2.1	143.5	—	477	695	2 300	3 400	NU3224	—	—	—	—	131	131	141	146	—	204	—	—	2	2	11.9
	260	55	3	3	154	226	485	551	2 200	3 000	NU324	NJ324	NUP324	N324	NF324	133	133	151	156	171	247	247	230	2.5	2.5	13.1
	260	55	3	3	154	—	528	610	2 200	3 000	NU324R	NJ324R	NUP324R	—	—	133	133	151	156	171	247	—	—	2.5	2.5	13.4
	260	86	3	3	154	—	708	918	2 000	3 000	NU2324	NJ2324	NUP2324	—	—	133	133	151	156	171	247	—	—	2.5	2.5	23.1
	260	86	3	3	154	—	793	1 030	2 000	3 000	NU2324R	NJ2324R	NUP2324R	—	—	133	133	151	156	172	247	—	—	2.5	2.5	23.1
	260	106	3	3	154	—	826	1 120	2 000	3 000	NU3324	—	—	—	—	133	133	151	156	—	247	—	—	2.5	2.5	28.3
	310	72	5	5	170	260	690	770	1 900	2 600	NU424	NJ424	NUP424	N424	NF424	140	140	168	172	190	290	290	262	4	4	28.0
	130	200	33	2	1.1	148	—	171	238	3 200	3 800	NU1026	—	NUP1026	—	—	139	136.5	146	151	—	191	—	—	2	1
230		40	3	3	156	204	282	362	2 700	3 200	NU226	NJ226	NUP226	N226	NF226	143	143	151	158	168	217	217	208	2.5	2.5	6.49
230		40	3	3	153.5	—	364	453	2 600	3 200	NU226R	NJ226R	NUP226R	—	—	143	143	151	158	168	217	—	—	2.5	2.5	6.60
230		64	3	3	156	—	395	560	2 400	3 200	NU2226	NJ2226	NUP2226	—	—	143	143	151	158	168	217	—	—	2.5	2.5	11.2
230		64	3	3	153.5	—	530	737	2 400	3 200	NU2226R	NJ2226R	NUP2226R	—	—	143	143	151	158	168	217	—	—	2.5	2.5	11.2
230		80	3	3	156	—	550	857	2 100	3 200	NU3226	—	—	—	—	143	143	151	158	—	217	—	—	2.5	2.5	14.1
280		58	4	4	167	243	564	667	2 100	2 700	NU326	NJ326	NUP326	N326	NF326	146	146	164	169	184	264	264	247	3	3	16.4
280		58	4	4	167	—	616	736	2 000	2 700	NU326R	NJ326R	NUP326R	—	—	146	146	164	169	184	264	—	—	3	3	16.7
280		93	4	4	167	—	838	1 130	1 800	2 700	NU2326	NJ2326	NUP2326	—	—	146	146	164	169	184	264	—	—	3	3	29.1
280		93	4	4	167	—	920	1 230	1 800	2 700	NU2326R	NJ2326R	NUP2326R	—	—	146	146	164	169	186	264	—	—	3	3	29.1
280		112	4	4	167	—	936	1 290	1 800	2 700	NU3326	—	—	—	—	146	146	164	169	—	264	—	—	3	3	34.6
340	78	5	5	185	285	771	876	1 800	2 300	NU426	NJ426	NUP426	N426	NF426	150	150	183	187	208	320	320	287	4	4	36.1	
140	210	33	2	1.1	158	—	175	250	3 000	3 600	NU1028	—	NUP1028	—	—	149	146.5	156	161	—	201	—	—	2	1	4.00
	250	42	3	3	169	221	324	421	2 400	2 900	NU228	NJ228	NUP228	N228	NF228	153	153	166	171	182	237	237	228	2.5	2.5	8.27
	250	42	3	3	169	—	392	514	2 400	2 900	NU228R	NJ228R	NUP228R	—	—	153	153	166	171	182	237	—	—	2.5	2.5	8.50

[Remarks] 1) Standard cage types used for the above bearings are shown in Table 1 earlier in this section. Please note that basic load ratings and limiting speeds shown above indicate the value applicable to machined cage. Consult JTEKT about bearings with pressed cage, since they may be different from bearings with machined cage in values above.

2) Bearing numbers of NU and NJ type bearings with mounted thrust collar (refer to specification table shown after this specification table) are NUJ and NH.

Single-row cylindrical roller bearings

d (140) ~ (160) mm

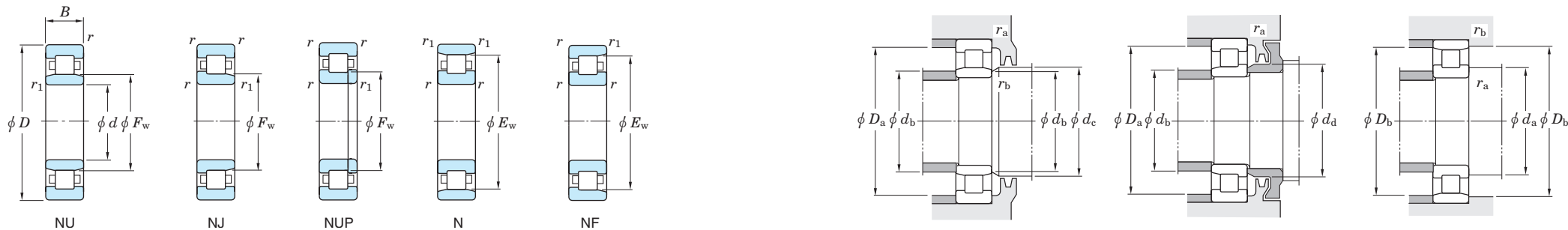

d	Boundary dimensions (mm)						Basic load ratings (kN)		Limiting speeds (min <sup>-1</sup> )		Bearing No.					Mounting dimensions (mm)								Mass NU (kg)		
	D	B	r <sub>min.</sub>	r <sub>1 min.</sub>	F <sub>w</sub>	E <sub>w</sub>	C <sub>r</sub>	C <sub>0r</sub>	Grease lub.	Oil lub.	NU	NJ	NUP	N	NF	d <sub>a min.</sub>	d <sub>b min.</sub>	d <sub>b max.</sub>	d <sub>c min.</sub>	d <sub>a min.</sub>	D <sub>a max.</sub>	D <sub>b max.</sub>	r <sub>a min.</sub>		r <sub>b max.</sub>	
140	250	68	3	3	169	—	465	671	2 200	2 900	<b>NU2228</b>	<b>NJ2228</b>	<b>NUP2228</b>	—	—	153	153	166	171	182	237	—	—	2.5	2.5	14.3
	250	68	3	3	169	—	572	835	2 200	2 900	<b>NU2228R</b>	<b>NJ2228R</b>	<b>NUP2228R</b>	—	—	153	153	166	171	182	237	—	—	2.5	2.5	14.3
	250	88	3	3	169	—	604	939	1 900	2 900	<b>NU3228</b>	—	—	—	—	153	153	166	171	—	237	—	—	2.5	2.5	18.5
	300	62	4	4	180	260	623	746	1 900	2 500	<b>NU328</b>	<b>NJ328</b>	<b>NUP328</b>	<b>N328</b>	<b>NF328</b>	156	156	176	182	198	284	284	264	3	3	21.8
	300	62	4	4	180	—	663	797	1 900	2 500	<b>NU328R</b>	<b>NJ328R</b>	<b>NUP328R</b>	—	—	156	156	176	182	198	284	—	—	3	3	21.8
	300	102	4	4	180	—	920	1 250	1 700	2 500	<b>NU2328</b>	<b>NJ2328</b>	<b>NUP2328</b>	—	—	156	156	176	182	198	284	—	—	3	3	36.8
	300	102	4	4	180	—	1 020	1 380	1 700	2 500	<b>NU2328R</b>	<b>NJ2328R</b>	<b>NUP2328R</b>	—	—	156	156	176	182	200	284	—	—	3	3	36.8
	300	118	4	4	180	—	1 090	1 550	1 700	2 500	<b>NU3328</b>	—	—	—	—	156	156	176	182	—	284	—	—	3	3	41.5
	360	82	5	5	198	302	874	1 020	1 600	2 200	<b>NU428</b>	<b>NJ428</b>	<b>NUP428</b>	<b>N428</b>	<b>NF428</b>	160	160	195	200	222	340	340	304	4	4	46.8
	150	225	35	2.1	1.5	169.5	—	201	281	2 800	3 300	<b>NU1030</b>	—	<b>NUP1030</b>	—	—	161	158	167	173	—	214	—	—	2	1.5
270		45	3	3	182	238	374	492	2 200	2 700	<b>NU230</b>	<b>NJ230</b>	<b>NUP230</b>	<b>N230</b>	<b>NF230</b>	163	163	179	184	196	257	257	245	2.5	2.5	10.3
270		45	3	3	182	—	448	594	2 200	2 600	<b>NU230R</b>	<b>NJ230R</b>	<b>NUP230R</b>	—	—	163	163	179	184	196	257	—	—	2.5	2.5	10.7
270		73	3	3	182	—	545	800	2 000	2 700	<b>NU2230</b>	<b>NJ2230</b>	<b>NUP2230</b>	—	—	163	163	179	184	196	257	—	—	2.5	2.5	18.7
270		73	3	3	182	—	662	982	2 000	2 600	<b>NU2230R</b>	<b>NJ2230R</b>	<b>NUP2230R</b>	—	—	163	163	179	184	196	257	—	—	2.5	2.5	18.7
270		96	3	3	182	—	749	1 200	1 800	2 700	<b>NU3230</b>	—	—	—	—	163	163	179	184	—	257	—	—	2.5	2.5	23.7
320		65	4	4	193	277	663	807	1 800	2 300	<b>NU330</b>	<b>NJ330</b>	<b>NUP330</b>	<b>N330</b>	<b>NF330</b>	166	166	190	195	213	304	304	281	3	3	26.4
320		65	4	4	193	—	757	922	1 700	2 300	<b>NU330R</b>	<b>NJ330R</b>	<b>NUP330R</b>	—	—	166	166	190	195	213	304	—	—	3	3	27.0
320		108	4	4	193	—	1 020	1 400	1 600	2 300	<b>NU2330</b>	<b>NJ2330</b>	<b>NUP2330</b>	—	—	166	166	190	195	213	304	—	—	3	3	44.7
320		108	4	4	193	—	1 180	1 600	1 500	2 300	<b>NU2330R</b>	<b>NJ2330R</b>	<b>NUP2330R</b>	—	—	166	166	190	195	213	304	—	—	3	3	44.7
320		128	4	4	193	—	1 290	1 890	1 600	2 300	<b>NU3330</b>	—	—	—	—	166	166	190	195	—	304	—	—	3	3	51.4
380		85	5	5	213	317	930	1 120	1 500	2 000	<b>NU430</b>	<b>NJ430</b>	<b>NUP430</b>	<b>N430</b>	<b>NF430</b>	170	170	210	216	237	360	360	319	4	4	53.3
160		240	38	2.1	1.5	180	—	236	330	2 600	3 000	<b>NU1032</b>	—	<b>NUP1032</b>	—	—	171	168	178	184	—	229	—	—	2	1.5
	290	48	3	3	195	255	427	568	2 100	2 500	<b>NU232</b>	<b>NJ232</b>	<b>NUP232</b>	<b>N232</b>	<b>NF232</b>	173	173	192	197	210	277	277	262	2.5	2.5	14.4
	290	48	3	3	195	—	498	666	2 000	2 400	<b>NU232R</b>	<b>NJ232R</b>	<b>NUP232R</b>	—	—	173	173	192	197	210	277	—	—	2.5	2.5	14.8
	290	80	3	3	195	—	631	939	1 800	2 500	<b>NU2232</b>	<b>NJ2232</b>	<b>NUP2232</b>	—	—	173	173	192	197	210	277	—	—	2.5	2.5	23.6
	290	80	3	3	193	—	809	1 190	1 800	2 400	<b>NU2232R</b>	<b>NJ2232R</b>	<b>NUP2232R</b>	—	—	173	173	192	197	210	277	—	—	2.5	2.5	23.6
	290	104	3	3	195	—	857	1 390	1 600	2 500	<b>NU3232</b>	—	—	—	—	173	173	192	197	—	277	—	—	2.5	2.5	29.8

[Remarks] 1) Standard cage types used for the above bearings are shown in Table 1 earlier in this section. Please note that basic load ratings and limiting speeds shown above indicate the value applicable to machined cage. Consult JTEKT about bearings with pressed cage, since they may be different from bearings with machined cage in values above.

2) Bearing numbers of NU and NJ type bearings with mounted thrust collar (refer to specification table shown after this specification table) are NUJ and NH.

Single-row cylindrical roller bearings

d (160) ~ (190) mm

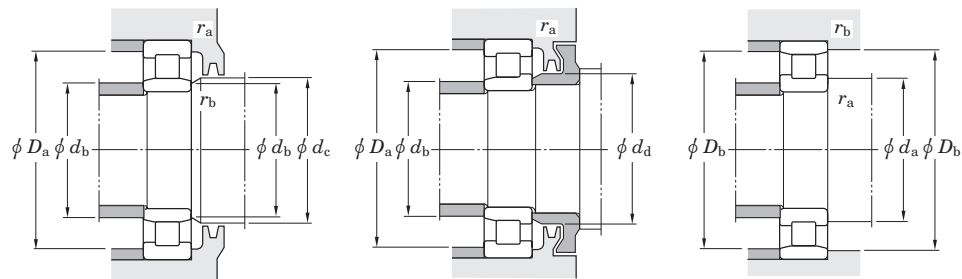
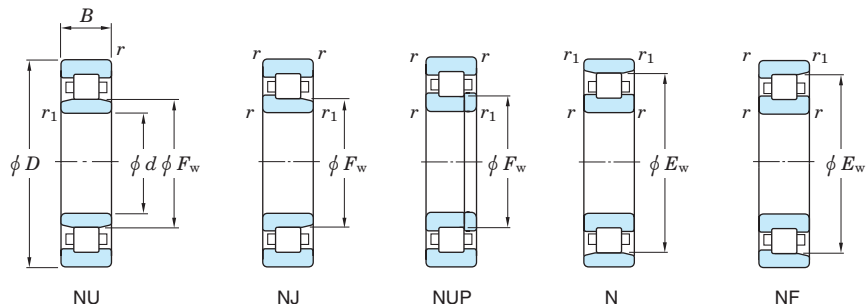

Boundary dimensions (mm)			Basic load ratings (kN)		Limiting speeds (min <sup>-1</sup> )		Bearing No.					Mounting dimensions (mm)								(Refer.)							
d	D	B	r min.	r1 min.	Fw	Ew	Cr	C0r	Grease lub.	Oil lub.	NU	NJ	NUP	N	NF	da min.	db min.	db max.	dc min.	da min.	Da max.	Db max.	ra min.	rb max.	ra max.	rb max.	Mass NU (kg)
160	340	68	4	4	208	292	698	876	1 600	2 200	<b>NU332</b>	<b>NJ332</b>	<b>NUP332</b>	<b>N332</b>	<b>NF332</b>	176	176	200	211	228	324	324	296	3	3	3	31.7
	340	68	4	4	204	—	857	1 050	1 600	2 100	<b>NU332R</b>	<b>NJ332R</b>	<b>NUP332R</b>	—	—	176	176	200	211	228	324	—	—	3	3	32.0	
	340	114	4	4	208	—	1 070	1 520	1 400	2 200	<b>NU2332</b>	<b>NJ2332</b>	<b>NUP2332</b>	—	—	176	176	200	211	228	324	—	—	3	3	53.1	
	340	114	4	4	204	—	1 310	1 820	1 400	2 100	<b>NU2332R</b>	<b>NJ2332R</b>	<b>NUP2332R</b>	—	—	176	176	200	211	228	324	—	—	3	3	53.1	
	340	136	4	4	208	—	1 270	1 890	1 400	2 200	<b>NU3332</b>	—	—	—	—	176	176	200	211	—	324	—	—	3	3	61.5	
170	260	42	2.1	2.1	193	—	276	400	2 400	2 800	<b>NU1034</b>	—	<b>NUP1034</b>	—	—	181	181	190	197	—	249	—	—	2	2	7.90	
	310	52	4	4	208	272	475	637	1 900	2 300	<b>NU234</b>	<b>NJ234</b>	<b>NUP234</b>	<b>N234</b>	<b>NF234</b>	186	186	204	211	223	294	294	280	3	3	18.4	
	310	52	4	4	207	—	603	802	1 900	2 200	<b>NU234R</b>	<b>NJ234R</b>	<b>NUP234R</b>	—	—	186	186	204	211	223	294	—	—	3	3	18.6	
	310	86	4	4	208	—	715	1 080	1 700	2 300	<b>NU2234</b>	<b>NJ2234</b>	<b>NUP2234</b>	—	—	186	186	204	211	223	294	—	—	3	3	29.2	
	310	86	4	4	205	—	967	1 410	1 700	2 200	<b>NU2234R</b>	<b>NJ2234R</b>	<b>NUP2234R</b>	—	—	186	186	204	211	223	294	—	—	3	3	29.2	
	310	110	4	4	208	—	964	1 580	1 500	2 300	<b>NU3234</b>	—	—	—	—	186	186	204	211	—	294	—	—	3	3	36.2	
	360	72	4	4	220	310	809	1 010	1 500	2 000	<b>NU334</b>	<b>NJ334</b>	<b>NUP334</b>	<b>N334</b>	<b>NF334</b>	186	186	216	223	241	344	344	314	3	3	38.6	
	360	120	4	4	220	—	1 220	1 750	1 300	2 000	<b>NU2334</b>	<b>NJ2334</b>	<b>NUP2334</b>	—	—	186	186	216	223	241	344	—	—	3	3	62.6	
	360	140	4	4	220	—	1 420	2 120	1 300	2 000	<b>NU3334</b>	—	—	—	—	186	186	216	223	—	344	—	—	3	3	70.8	
180	280	46	2.1	2.1	205	—	356	503	2 200	2 600	<b>NU1036</b>	—	<b>NUP1036</b>	—	—	191	191	203	209	—	269	—	—	2	2	10.5	
	320	52	4	4	218	282	492	677	1 800	2 200	<b>NU236</b>	<b>NJ236</b>	<b>NUP236</b>	<b>N236</b>	<b>NF236</b>	196	196	214	221	233	304	304	290	3	3	19.3	
	320	52	4	4	217	—	626	852	1 800	2 100	<b>NU236R</b>	<b>NJ236R</b>	<b>NUP236R</b>	—	—	196	196	214	221	233	304	—	—	3	3	19.3	
	320	86	4	4	218	—	741	1 140	1 600	2 200	<b>NU2236</b>	<b>NJ2236</b>	<b>NUP2236</b>	—	—	196	196	214	221	233	304	—	—	3	3	30.4	
	320	86	4	4	215	—	1 010	1 510	1 600	2 100	<b>NU2236R</b>	<b>NJ2236R</b>	<b>NUP2236R</b>	—	—	196	196	214	221	233	304	—	—	3	3	30.4	
	320	112	4	4	218	—	999	1 680	1 400	2 200	<b>NU3236</b>	—	—	—	—	196	196	214	221	—	304	—	—	3	3	38.4	
	380	75	4	4	232	328	917	1 150	1 400	1 900	<b>NU336</b>	<b>NJ336</b>	<b>NUP336</b>	<b>N336</b>	<b>NF336</b>	196	196	227	235	255	364	364	332	3	3	42.6	
	380	126	4	4	232	—	1 350	1 940	1 300	1 900	<b>NU2336</b>	<b>NJ2336</b>	<b>NUP2336</b>	—	—	196	196	227	235	255	364	—	—	3	3	73.0	
	380	150	4	4	232	—	1 660	2 520	1 300	1 900	<b>NU3336</b>	—	—	—	—	196	196	227	235	—	364	—	—	3	3	84.4	
190	290	46	2.1	2.1	215	—	366	530	2 100	2 500	<b>NU1038</b>	—	<b>NUP1038</b>	—	—	201	201	213	219	—	279	—	—	2	2	10.9	
	340	55	4	4	231	299	554	768	1 700	2 000	<b>NU238</b>	<b>NJ238</b>	<b>NUP238</b>	<b>N238</b>	<b>NF238</b>	206	206	227	234	247	324	324	310	3	3	23.2	
	340	55	4	4	230	—	694	954	1 700	2 000	<b>NU238R</b>	<b>NJ238R</b>	<b>NUP238R</b>	—	—	206	206	227	234	247	324	—	—	3	3	23.3	
	340	92	4	4	231	—	828	1 290	1 500	2 000	<b>NU2238</b>	<b>NJ2238</b>	<b>NUP2238</b>	—	—	206	206	227	234	247	324	—	—	3	3	37.0	

[Remarks] 1) Standard cage types used for the above bearings are shown in Table 1 earlier in this section. Please note that basic load ratings and limiting speeds shown above indicate the value applicable to machined cage. Consult JTEKT about bearings with pressed cage, since they may be different from bearings with machined cage in values above.

2) Bearing numbers of NU and NJ type bearings with mounted thrust collar (refer to specification table shown after this specification table) are NUJ and NH.

Single-row cylindrical roller bearings

d (190) ~ (240) mm

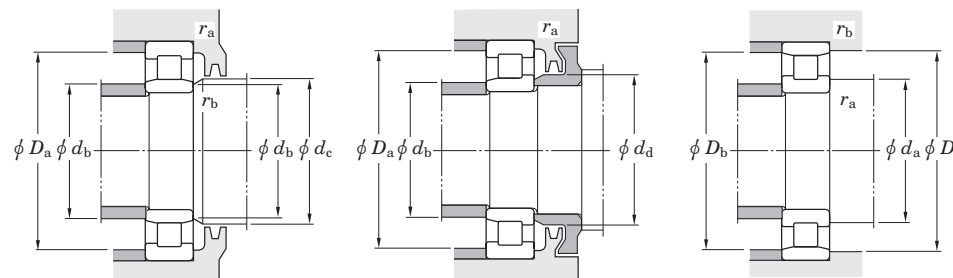
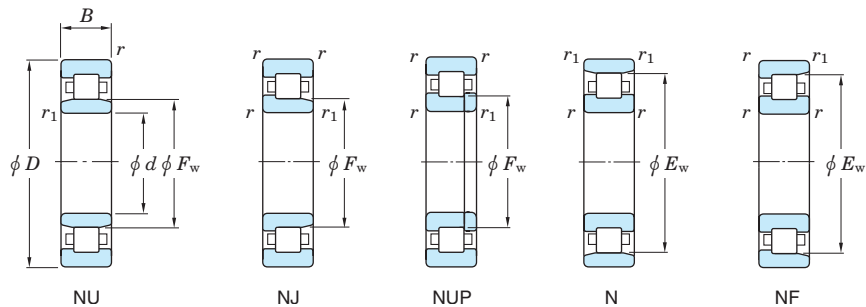

Boundary dimensions (mm)								Basic load ratings (kN)		Limiting speeds (min <sup>-1</sup> )		Bearing No.					Mounting dimensions (mm)								Mass NU (kg)	
d	D	B	r min.	r1 min.	Fw	Ew	Cr	C0r	Grease lub.	Oil lub.	NU	NJ	NUP	N	NF	da min.	db min.	db max.	dc min.	da min.	Da max.	Db max.	rb min.	ra max.		rb max.
190	340	92	4	4	228	—	1 100	1 670	1 500	2 000	<b>NU2238R</b>	<b>NJ2238R</b>	<b>NUP2238R</b>	—	—	206	206	227	234	247	324	—	—	3	3	37.0
	340	120	4	4	231	—	1 310	1 930	1 300	2 000	<b>NU3238</b>	—	—	—	—	206	206	227	234	—	324	—	—	3	3	46.8
	400	78	5	5	245	345	987	1 260	1 300	1 800	<b>NU338</b>	<b>NJ338</b>	<b>NUP338</b>	<b>N338</b>	<b>NF338</b>	210	210	240	248	268	380	380	349	4	4	49.9
	400	132	5	5	245	—	1 520	2 220	1 200	1 800	<b>NU2338</b>	<b>NJ2338</b>	<b>NUP2338</b>	—	—	210	210	240	248	268	380	—	—	4	4	84.7
	400	155	5	5	245	—	1 870	2 910	1 200	1 800	<b>NU3338</b>	—	—	—	—	210	210	240	248	—	380	—	—	4	4	96.5
200	310	51	2.1	2.1	229	—	388	582	1 900	2 300	<b>NU1040</b>	—	<b>NUP1040</b>	—	—	211	211	226	233	—	299	—	—	2	2	14.1
	360	58	4	4	244	316	618	865	1 600	1 900	<b>NU240</b>	<b>NJ240</b>	<b>NUP240</b>	<b>N240</b>	<b>NF240</b>	216	216	240	247	261	344	344	328	3	3	26.8
	360	58	4	4	243	—	766	1 060	1 600	1 900	<b>NU240R</b>	<b>NJ240R</b>	<b>NUP240R</b>	—	—	216	216	240	247	261	344	—	—	3	3	27.2
	360	98	4	4	244	—	946	1 490	1 400	1 900	<b>NU2240</b>	<b>NJ2240</b>	<b>NUP2240</b>	—	—	216	216	240	247	261	344	—	—	3	3	44.4
	360	98	4	4	241	—	1 220	1 870	1 400	1 900	<b>NU2240R</b>	<b>NJ2240R</b>	<b>NUP2240R</b>	—	—	216	216	240	247	261	344	—	—	3	3	44.4
	360	128	4	4	244	—	1 200	2 020	1 300	1 900	<b>NU3240</b>	—	—	—	—	216	216	240	247	—	344	—	—	3	3	56.2
	420	80	5	5	260	360	987	1 270	1 200	1 700	<b>NU340</b>	<b>NJ340</b>	<b>NUP340</b>	<b>N340</b>	<b>NF340</b>	220	220	254	263	283	400	400	364	4	4	56.2
	420	138	5	5	260	—	1 520	2 240	1 100	1 700	<b>NU2340</b>	<b>NJ2340</b>	<b>NUP2340</b>	—	—	220	220	254	263	283	400	—	—	4	4	97.4
	420	165	5	5	260	—	1 870	2 930	1 100	1 700	<b>NU3340</b>	—	—	—	—	220	220	250	258	—	400	—	—	4	4	113
220	340	56	3	3	250	—	507	748	1 700	2 000	<b>NU1044</b>	—	<b>NUP1044</b>	—	—	233	233	248	254	—	327	—	—	2.5	2.5	18.5
	400	65	4	4	270	350	766	1 080	1 400	1 700	<b>NU244</b>	<b>NJ244</b>	<b>NUP244</b>	<b>N244</b>	<b>NF244</b>	236	236	266	273	289	384	384	362	3	3	38.5
	400	108	4	4	270	—	1 130	1 810	1 200	1 700	<b>NU244</b>	<b>NJ244</b>	—	—	—	236	236	266	273	289	384	—	—	3	3	60.9
	400	144	4	4	270	—	1 630	2 880	1 100	1 700	<b>NU3244</b>	—	—	—	—	236	236	266	273	—	384	—	—	3	3	78.8
	460	88	5	5	284	396	1 200	1 570	1 100	1 500	<b>NU344</b>	<b>NJ344</b>	<b>NUP344</b>	<b>N344</b>	<b>NF344</b>	240	240	279	287	309	440	440	400	4	4	74.4
	460	145	5	5	284	—	1 810	2 690	990	1 500	<b>NU2344</b>	—	<b>NUP2344</b>	—	—	240	240	276	287	—	440	—	—	4	4	119
	460	180	5	5	284	—	2 130	3 300	990	1 500	<b>NU3344</b>	—	—	—	—	240	240	279	287	—	440	—	—	4	4	148
240	360	56	3	3	270	—	535	822	1 600	1 900	<b>NU1048</b>	—	<b>NUP1048</b>	—	—	253	253	268	275	—	347	—	—	2.5	2.5	20.1
	440	72	4	4	295	385	949	1 340	1 200	1 500	<b>NU248</b>	<b>NJ248</b>	<b>NUP248</b>	<b>N248</b>	<b>NF248</b>	256	256	293	298	316	424	424	397	3	3	52.1
	440	120	4	4	295	—	1 430	2 320	1 100	1 500	<b>NU248</b>	<b>NJ248</b>	—	—	—	256	256	293	298	316	424	—	—	3	3	82.5
	440	160	4	4	295	—	1 950	3 460	990	1 500	<b>NU3248</b>	—	—	—	—	256	256	293	298	—	424	—	—	3	3	107
	500	95	5	5	310	430	1 430	1 950	990	1 300	<b>NU348</b>	<b>NJ348</b>	<b>NUP348</b>	<b>N348</b>	<b>NF348</b>	260	260	305	313	337	480	480	434	4	4	94.6
	500	155	5	5	310	—	2 170	3 320	880	1 300	<b>NU2348</b>	—	<b>NUP2348</b>	—	—	260	260	303	313	—	480	—	—	4	4	152

[Remarks] 1) Standard cage types used for the above bearings are shown in Table 1 earlier in this section. Please note that basic load ratings and limiting speeds shown above indicate the value applicable to machined cage. Consult JTEKT about bearings with pressed cage, since they may be different from bearings with machined cage in values above.

2) Bearing numbers of NU and NJ type bearings with mounted thrust collar (refer to specification table shown after this specification table) are NUJ and NH.

Single-row cylindrical roller bearings

d (240) ~ 460 mm

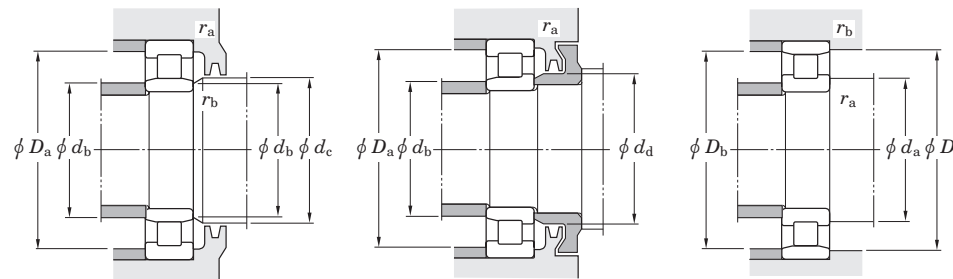
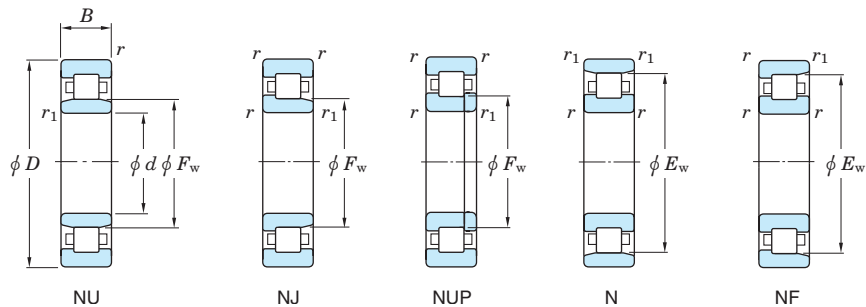

Boundary dimensions (mm)								Basic load ratings (kN)		Limiting speeds (min <sup>-1</sup> )		Bearing No.					Mounting dimensions (mm)								(Refer.)	
d	D	B	r	r <sub>1</sub>	F <sub>w</sub>	E <sub>w</sub>	C <sub>r</sub>	C <sub>0r</sub>	Grease lub.	Oil lub.	NU	NJ	NUP	N	NF	d <sub>a</sub>	d <sub>b</sub>	d <sub>c</sub>	d <sub>a</sub>	D <sub>a</sub>	D <sub>b</sub>	r <sub>a</sub>	r <sub>b</sub>	Mass NU (kg)		
			min.	min.												min.	min.	max.	min.	min.	max.	max.	min.	max.		
<b>240</b>	500	195	5	5	310	—	2 540	4 070	880	1 300	<b>NU3348</b>	—	—	—	—	260	260	305	313	—	480	—	—	4	4	189
<b>260</b>	400	65	4	4	296	—	651	979	1 400	1 700	<b>NU1052</b>	—	<b>NUP1052</b>	—	—	276	276	292	300	—	384	—	—	3	3	29.2
	480	80	5	5	320	420	1 100	1 580	1 100	1 300	<b>NU252</b>	<b>NJ252</b>	<b>NUP252</b>	<b>N252</b>	<b>NF252</b>	280	280	318	323	343	460	460	432	4	4	69.0
	480	130	5	5	320	—	1 790	2 950	990	1 300	<b>NU2252</b>	<b>NJ2252</b>	—	—	—	280	280	318	323	343	460	—	—	4	4	107
	480	174	5	5	320	—	2 140	3 680	880	1 300	<b>NU3252</b>	—	—	—	—	280	280	318	323	—	460	—	—	4	4	139
	540	165	6	6	336	—	2 430	3 750	790	1 200	<b>NU2352</b>	—	<b>NUP2352</b>	—	—	284	284	327	339	—	516	—	—	5	5	185
	540	206	6	6	336	—	2 940	4 790	790	1 200	<b>NU3352</b>	—	—	—	—	284	284	330	339	—	516	—	—	5	5	232
<b>280</b>	420	65	4	4	316	—	669	1 030	1 300	1 500	<b>NU1056</b>	—	<b>NUP1056</b>	—	—	296	296	313	320	—	404	—	—	3	3	35.2
	500	80	5	5	340	440	1 140	1 680	1 000	1 200	<b>NU256</b>	<b>NJ256</b>	<b>NUP256</b>	<b>N256</b>	<b>NF256</b>	300	300	336	343	365	480	480	452	4	4	72.7
<b>300</b>	460	74	4	4	340	—	890	1 380	1 200	1 400	<b>NU1060</b>	—	<b>NUP1060</b>	—	—	316	316	337	344	—	444	—	—	3	3	44.1
	540	85	5	5	364	476	1 350	1 960	920	1 100	<b>NU260</b>	<b>NJ260</b>	<b>NUP260</b>	<b>N260</b>	<b>NF260</b>	320	320	361	368	392	520	520	487	4	4	90.7
<b>320</b>	480	74	4	4	360	—	913	1 450	1 100	1 300	<b>NU1064</b>	—	<b>NUP1064</b>	—	—	336	336	356	365	—	464	—	—	3	3	48.4
	580	92	5	5	390	510	1 540	2 270	840	1 000	<b>NU264</b>	<b>NJ264</b>	<b>NUP264</b>	<b>N264</b>	<b>NF264</b>	340	340	386	393	419	560	560	522	4	4	114
	670	112	7.5	7.5	425	—	1 970	2 880	650	870	<b>NU364</b>	—	—	—	—	352	352	419	428	—	638	638	575	6	6	199
<b>340</b>	520	82	5	5	385	—	1 090	1 750	980	1 200	<b>NU1068</b>	—	<b>NUP1068</b>	—	—	360	360	381	390	—	500	—	—	4	4	64.1
<b>360</b>	540	82	5	5	405	—	1 120	1 830	920	1 100	<b>NU1072</b>	—	<b>NUP1072</b>	—	—	380	380	401	410	—	520	—	—	4	4	67.1
<b>380</b>	560	82	5	5	425	—	1 150	1 920	860	1 000	<b>NU1076</b>	—	<b>NUP1076</b>	—	—	400	400	421	430	—	540	—	—	4	4	70.1
<b>400</b>	600	90	5	5	450	—	1 400	2 310	780	920	<b>NU1080</b>	—	<b>NUP1080</b>	—	—	420	420	446	455	—	580	—	—	4	4	91.0
<b>420</b>	620	90	5	5	470	—	1 390	2 320	730	860	<b>NU1084</b>	—	<b>NUP1084</b>	—	—	440	440	466	475	—	600	—	—	4	4	94.6
<b>440</b>	650	94	6	6	493	—	1 490	2 520	680	800	<b>NU1088</b>	—	<b>NUP1088</b>	—	—	464	464	489	498	—	626	—	—	5	5	109
<b>460</b>	680	100	6	6	516	—	1 590	2 730	630	750	<b>NU1092</b>	—	<b>NUP1092</b>	—	—	484	484	512	520	—	656	—	—	5	5	127

(Remarks) 1) Standard cage types used for the above bearings are shown in Table 1 earlier in this section. Please note that basic load ratings and limiting speeds shown above indicate the value applicable to machined cage. Consult JTEKT about bearings with pressed cage, since they may be different from bearings with machined cage in values above.

2) Bearing numbers of NU and NJ type bearings with mounted thrust collar (refer to specification table shown after this specification table) are NUJ and NH.

Thrust collars for cylindrical roller bearings

$d$  20 ~ (35) mm

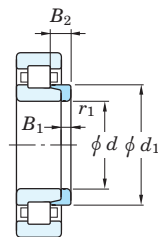

Thrust collar

$d$	Boundary dimensions (mm)				Thrust collar No.	(Refer.) Mass (kg)	Applicable bearing No.		
	$d_1$	$B_1$	$B_2$	$r_1$ min.			NJ	NU	
20	29.7	3	6.75	0.6	HJ204	0.012	NJ204	NU204	
	29.8	3	5.5	0.6	HJ204R	0.011	NJ204R	NU204R	
	30	3	7.5	0.6	HJ2204	0.012	NJ2204	NU2204	
	29.8	3	6.5	0.6	HJ2204R	0.012	NJ2204R	NU2204R	
	31.8	4	7.5	0.6	HJ304	0.017	NJ304	NU304	
	31.4	4	6.5	0.6	HJ304R	0.017	NJ304R	NU304R	
	31.8	4	8.5	0.6	HJ2304	0.020	NJ2304	NU2304	
	31.4	4	7.5	0.6	HJ2304R	0.018	NJ2304R	NU2304R	
	25	34.7	3	7.25	0.6	HJ205	0.015	NJ205	NU205
		34.8	3	6	0.6	HJ205R	0.014	NJ205R	NU205R
34.7		3	7.5	0.6	HJ2205	0.015	NJ2205	NU2205	
34.8		3	6.5	0.6	HJ2205R	0.014	NJ2205R	NU2205R	
39		4	8	1.1	HJ305	0.025	NJ305	NU305	
38.2		4	7	1.1	HJ305R	0.025	NJ305R	NU305R	
39		4	9	1.1	HJ2305	0.025	NJ2305	NU2305	
38.2		4	8	1.1	HJ2305R	0.026	NJ2305R	NU2305R	
30		41.8	4	8.25	0.6	HJ206	0.025	NJ206	NU206
		41.4	4	7	0.6	HJ206R	0.025	NJ206R	NU206R
	41.8	4	8.5	0.6	HJ2206	0.025	NJ2206	NU2206	
	41.4	4	7.5	0.6	HJ2206R	0.025	NJ2206R	NU2206R	
	45.9	5	9.5	1.1	HJ306	0.039	NJ306	NU306	
	45.1	5	8.5	1.1	HJ306R	0.042	NJ306R	NU306R	
	45.9	5	11.5	1.1	HJ2306	0.039	NJ2306	NU2306	
	45.1	5	9.5	1.1	HJ2306R	0.043	NJ2306R	NU2306R	
	50.5	7	11.5	1.5	HJ406	0.080	NJ406	NU406	
	35	47.6	4	8	0.6	HJ207	0.030	NJ207	NU207
48.2		4	7	0.6	HJ207R	0.033	NJ207R	NU207R	
47.6		4	8.5	0.6	HJ2207	0.030	NJ2207	NU2207	

$d$  (35) ~ (50) mm

$d$	Boundary dimensions (mm)				Thrust collar No.	(Refer.) Mass (kg)	Applicable bearing No.	
	$d_1$	$B_1$	$B_2$	$r_1$ min.			NJ	NU
35	48.2	4	8.5	0.6	HJ2207R	0.035	NJ2207R	NU2207R
	50.8	6	11	1.1	HJ307	0.056	NJ307	NU307
	51.1	6	9.5	1.1	HJ307R	0.060	NJ307R	NU307R
	50.8	6	14	1.1	HJ2307	0.056	NJ2307	NU2307
	51.1	6	11	1.1	HJ2307R	0.062	NJ2307R	NU2307R
	59	8	13	1.5	HJ407	0.120	NJ407	NU407
	40	54.2	5	9	1.1	HJ208	0.046	NJ208
54.1		5	8.5	1.1	HJ208R	0.049	NJ208R	NU208R
54.2		5	9.5	1.1	HJ2208	0.046	NJ2208	NU2208
54.1		5	9	1.1	HJ2208R	0.050	NJ2208R	NU2208R
58.4		7	12.5	1.5	HJ308	0.083	NJ308	NU308
57.7		7	11	1.5	HJ308R	0.088	NJ308R	NU308R
58.4		7	14.5	1.5	HJ2308	0.083	NJ2308	NU2308
57.7		7	12.5	1.5	HJ2308R	0.091	NJ2308R	NU2308R
64.8		8	13	2	HJ408	0.140	NJ408	NU408
45		59	5	9.5	1.1	HJ209	0.053	NJ209
	59.1	5	8.5	1.1	HJ209R	0.055	NJ209R	NU209R
	59	5	9.5	1.1	HJ2209	0.053	NJ2209	NU2209
	59.1	5	9	1.1	HJ2209R	0.055	NJ2209R	NU2209R
	64	7	12.5	1.5	HJ309	0.099	NJ309	NU309
	64.5	7	11.5	1.5	HJ309R	0.110	NJ309R	NU309R
	64	7	15	1.5	HJ2309	0.099	NJ2309	NU2309
	64.5	7	13	1.5	HJ2309R	0.113	NJ2309R	NU2309R
	71.8	8	13.5	2	HJ409	0.175	NJ409	NU409
	50	64.6	5	10	1.1	HJ210	0.063	NJ210
64.1		5	9	1.1	HJ210R	0.061	NJ210R	NU210R
64.6		5	9.5	1.1	HJ2210	0.063	NJ2210	NU2210
64.1		5	9	1.1	HJ2210R	0.061	NJ2210R	NU2210R
71		8	14	2	HJ310	0.142	NJ310	NU310



Thrust collars for cylindrical roller bearings

$d$  (50) ~ (65) mm

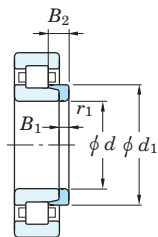

Thrust collar

$d$	Boundary dimensions (mm)				Thrust collar No.	(Refer.) Mass (kg)	Applicable bearing No.	
	$d_1$	$B_1$	$B_2$	$r_1$ min.			NJ	NU
50	71.4	8	13	2	HJ310R	0.151	NJ310R	NU310R
	71	8	17	2	HJ2310	0.142	NJ2310	NU2310
	71.4	8	14.5	2	HJ2310R	0.155	NJ2310R	NU2310R
	78.8	9	14.5	2.1	HJ410	0.230	NJ410	NU410
55	70.8	6	11	1.1	HJ211	0.084	NJ211	NU211
	70.9	6	9.5	1.1	HJ211R	0.087	NJ211R	NU211R
	70.8	6	11	1.1	HJ2211	0.084	NJ2211	NU2211
	70.9	6	10	1.1	HJ2211R	0.088	NJ2211R	NU2211R
	77.2	9	15	2	HJ311	0.182	NJ311	NU311
	77.6	9	14	2	HJ311R	0.195	NJ311R	NU311R
	77.2	9	18.5	2	HJ2311	0.182	NJ2311	NU2311
	77.6	9	15.5	2	HJ2311R	0.200	NJ2311R	NU2311R
	85.2	10	16.5	2.1	HJ411	0.290	NJ411	NU411
	60	78.4	6	11	1.5	HJ212	0.108	NJ212
77.7		6	10	1.5	HJ212R	0.108	NJ212R	NU212R
78.4		6	11	1.5	HJ2212	0.108	NJ2212	NU2212
77.7		6	10	1.5	HJ2212R	0.108	NJ2212R	NU2212R
84.2		9	15.5	2.1	HJ312	0.220	NJ312	NU312
84.5		9	14.5	2.1	HJ312R	0.231	NJ312R	NU312R
84.2		9	19	2.1	HJ2312	0.220	NJ2312	NU2312
84.5		9	16	2.1	HJ2312R	0.237	NJ2312R	NU2312R
91.8		10	16.5	2.1	HJ412	0.340	NJ412	NU412
65		84.8	6	11	1.5	HJ213	0.123	NJ213
	84.5	6	10	1.5	HJ213R	0.129	NJ213R	NU213R
	84.8	6	11.5	1.5	HJ2213	0.123	NJ2213	NU2213
	84.5	6	10.5	1.5	HJ2213R	0.131	NJ2213R	NU2213R
	91	10	17	2.1	HJ313	0.280	NJ313	NU313
	90.6	10	15.5	2.1	HJ313R	0.288	NJ313R	NU313R

$d$  (65) ~ (80) mm

$d$	Boundary dimensions (mm)				Thrust collar No.	(Refer.) Mass (kg)	Applicable bearing No.	
	$d_1$	$B_1$	$B_2$	$r_1$ min.			NJ	NU
65	91	10	20	2.1	HJ2313	0.280	NJ2313	NU2313
	90.6	10	18	2.1	HJ2313R	0.298	NJ2313R	NU2313R
	98.5	11	18	2.1	HJ413	0.420	NJ413	NU413
70	89.6	7	12.5	1.5	HJ214	0.150	NJ214	NU214
	89.5	7	11	1.5	HJ214R	0.157	NJ214R	NU214R
	89.6	7	12.5	1.5	HJ2214	0.150	NJ2214	NU2214
	89.5	7	11.5	1.5	HJ2214R	0.158	NJ2214R	NU2214R
	98	10	17.5	2.1	HJ314	0.330	NJ314	NU314
	97.5	10	15.5	2.1	HJ314R	0.330	NJ314R	NU314R
	98	10	20.5	2.1	HJ2314	0.330	NJ2314	NU2314
	97.5	10	18.5	2.1	HJ2314R	0.345	NJ2314R	NU2314R
	110.5	12	20	3	HJ414	0.605	NJ414	NU414
	75	94	7	12.5	1.5	HJ215	0.156	NJ215
94.5		7	11	1.5	HJ215R	0.166	NJ215R	NU215R
94		7	12.5	1.5	HJ2215	0.156	NJ2215	NU2215
94.5		7	11.5	1.5	HJ2215R	0.167	NJ2215R	NU2215R
104.2		11	18.5	2.1	HJ315	0.400	NJ315	NU315
104.2		11	16.5	2.1	HJ315R	0.410	NJ315R	NU315R
104.2		11	21.5	2.1	HJ2315	0.400	NJ2315	NU2315
104.2		11	19.5	2.1	HJ2315R	0.430	NJ2315R	NU2315R
116		13	21.5	3	HJ415	0.710	NJ415	NU415
80		101.2	8	13.5	2	HJ216	0.207	NJ216
	101.6	8	12.5	2	HJ216R	0.222	NJ216R	NU216R
	101.2	8	13.5	2	HJ2216	0.207	NJ2216	NU2216
	101.6	8	12.5	2	HJ2216R	0.222	NJ2216R	NU2216R
	111.8	11	19.5	2.1	HJ316	0.470	NJ316	NU316
	110.6	11	17	2.1	HJ316R	0.460	NJ316R	NU316R
	111.8	11	23	2.1	HJ2316	0.470	NJ2316	NU2316
	110.6	11	20	2.1	HJ2316R	0.480	NJ2316R	NU2316R

Thrust collars for cylindrical roller bearings

$d$  (80) ~ (100) mm

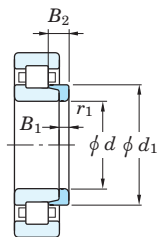

Thrust collar

Boundary dimensions (mm)					Thrust collar No.	(Refer.) Mass (kg)	Applicable bearing No.	
$d$	$d_1$	$B_1$	$B_2$	$r_{1 \text{ min.}}$			NJ	NU
<b>80</b>	122	13	22	3	<b>HJ416</b>	0.780	NJ416	NU416
<b>85</b>	108.2	8	14	2	<b>HJ217</b>	0.250	NJ217	NU217
	107.6	8	12.5	2	<b>HJ217R</b>	0.250	NJ217R	NU217R
	108.2	8	14	2	<b>HJ2217</b>	0.250	NJ2217	NU2217
	107.6	8	13	2	<b>HJ2217R</b>	0.252	NJ2217R	NU2217R
	117.5	12	20.5	3	<b>HJ317</b>	0.560	NJ317	NU317
	117.9	12	18.5	3	<b>HJ317R</b>	0.575	NJ317R	NU317R
	117.5	12	24	3	<b>HJ2317</b>	0.560	NJ2317	NU2317
	117.9	12	22	3	<b>HJ2317R</b>	0.595	NJ2317R	NU2317R
126	14	24	4	<b>HJ417</b>	0.880	NJ417	NU417	
<b>90</b>	114.2	9	15	2	<b>HJ218</b>	0.305	NJ218	NU218
	114.4	9	14	2	<b>HJ218R</b>	0.320	NJ218R	NU218R
	114.2	9	16	2	<b>HJ2218</b>	0.305	NJ2218	NU2218
	114.4	9	15	2	<b>HJ2218R</b>	0.325	NJ2218R	NU2218R
	125	12	21	3	<b>HJ318</b>	0.630	NJ318	NU318
	124.2	12	18.5	3	<b>HJ318R</b>	0.630	NJ318R	NU318R
	125	12	26	3	<b>HJ2318</b>	0.630	NJ2318	NU2318
	124.2	12	22	3	<b>HJ2318R</b>	0.660	NJ2318R	NU2318R
	137	14	24	4	<b>HJ418</b>	1.05	NJ418	NU418
	<b>95</b>	121	9	15.5	2.1	<b>HJ219</b>	0.352	NJ219
120.6		9	14	2.1	<b>HJ219R</b>	0.355	NJ219R	NU219R
121		9	16.5	2.1	<b>HJ2219</b>	0.352	NJ2219	NU2219
120.6		9	15.5	2.1	<b>HJ2219R</b>	0.365	NJ2219R	NU2219R
132		13	22.5	3	<b>HJ319</b>	0.760	NJ319	NU319
132.2		13	20.5	3	<b>HJ319R</b>	0.785	NJ319R	NU319R
132		13	26.5	3	<b>HJ2319</b>	0.760	NJ2319	NU2319
147		15	25.5	4	<b>HJ419</b>	1.30	NJ419	NU419
<b>100</b>	128	10	17	2.1	<b>HJ220</b>	0.444	NJ220	NU220

$d$  (100) ~ 120 mm

Boundary dimensions (mm)					Thrust collar No.	(Refer.) Mass (kg)	Applicable bearing No.		
$d$	$d_1$	$B_1$	$B_2$	$r_{1 \text{ min.}}$			NJ	NU	
<b>100</b>	127.5	10	15	2.1	<b>HJ220R</b>	0.435	NJ220R	NU220R	
	128	10	18	2.1	<b>HJ2220</b>	0.444	NJ2220	NU2220	
	127.5	10	16	2.1	<b>HJ2220R</b>	0.450	NJ2220R	NU2220R	
	140.5	13	22.5	3	<b>HJ320</b>	0.895	NJ320	NU320	
	139.6	13	20.5	3	<b>HJ320R</b>	0.890	NJ320R	NU320R	
	140.5	13	27.5	3	<b>HJ2320</b>	0.895	NJ2320	NU2320	
	139.6	13	23.5	3	<b>HJ2320R</b>	0.920	NJ2320R	NU2320R	
	153.5	16	27	4	<b>HJ420</b>	1.50	NJ420	NU420	
	<b>105</b>	135	10	17.5	2.1	<b>HJ221</b>	0.505	NJ221	NU221
		147	13	22.5	3	<b>HJ321</b>	0.970	NJ321	NU321
159.5		16	27	4	<b>HJ421</b>	1.65	NJ421	NU421	
<b>110</b>	141.5	11	18.5	2.1	<b>HJ222</b>	0.615	NJ222	NU222	
	141.7	11	17	2.1	<b>HJ222R</b>	0.620	NJ222R	NU222R	
	141.5	11	20.5	2.1	<b>HJ2222</b>	0.615	NJ2222	NU2222	
	141.7	11	19.5	2.1	<b>HJ2222R</b>	0.645	NJ2222R	NU2222R	
	155.5	14	23	3	<b>HJ322</b>	1.17	NJ322	NU322	
	155.8	14	22	3	<b>HJ322R</b>	1.21	NJ322R	NU322R	
	155.5	14	28	3	<b>HJ2322</b>	1.17	NJ2322	NU2322	
	155.8	14	26.5	3	<b>HJ2322R</b>	1.27	NJ2322R	NU2322R	
	171	17	29.5	4	<b>HJ422</b>	2.10	NJ422	NU422	
	<b>120</b>	153	11	19	2.1	<b>HJ224</b>	0.715	NJ224	NU224
153.4		11	17	2.1	<b>HJ224R</b>	0.710	NJ224R	NU224R	
153		11	22	2.1	<b>HJ2224</b>	0.715	NJ2224	NU2224	
153.4		11	20	2.1	<b>HJ2224R</b>	0.745	NJ2224R	NU2224R	
168.5		14	23.5	3	<b>HJ324</b>	1.40	NJ324	NU324	
168.6		14	22.5	3	<b>HJ324R</b>	1.41	NJ324R	NU324R	
168.5		14	28	3	<b>HJ2324</b>	1.40	NJ2324	NU2324	
168.6		14	26	3	<b>HJ2324R</b>	1.46	NJ2324R	NU2324R	
188		17	30.5	5	<b>HJ424</b>	2.60	NJ424	NU424	

Thrust collars for cylindrical roller bearings

$d$  130 ~ (160) mm

$d$  (160) ~ (200) mm

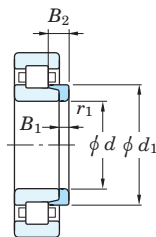

Thrust collar

$d$	Boundary dimensions (mm)				$r_1$ min.	Thrust collar No.	(Refer.) Mass (kg)	Applicable bearing No.	
	$d_1$	$B_1$	$B_2$					NJ	NU
<b>130</b>	165.5	11	19		3	<b>HJ226</b>	0.840	NJ226	NU226
	164.2	11	17		3	<b>HJ226R</b>	0.790	NJ226R	NU226R
	165.5	11	25		3	<b>HJ2226</b>	0.840	NJ2226	NU2226
	164.2	11	21		3	<b>HJ2226R</b>	0.840	NJ2226R	NU2226R
	182	14	24		4	<b>HJ326</b>	1.62	NJ326	NU326
	182.3	14	23		4	<b>HJ326R</b>	1.65	NJ326R	NU326R
	182	14	29.5		4	<b>HJ2326</b>	1.62	NJ2326	NU2326
	182.3	14	28		4	<b>HJ2326R</b>	1.73	NJ2326R	NU2326R
	205	18	32		5	<b>HJ426</b>	3.30	NJ426	NU426
	<b>140</b>	179.5	11	19		3	<b>HJ228</b>	1.00	NJ228
180		11	18		3	<b>HJ228R</b>	0.990	NJ228R	NU228R
179.5		11	25		3	<b>HJ2228</b>	1.00	NJ2228	NU2228
180		11	23		3	<b>HJ2228R</b>	1.07	NJ2228R	NU2228R
196		15	26		4	<b>HJ328</b>	1.93	NJ328	NU328
196		15	25		4	<b>HJ328R</b>	2.04	NJ328R	NU328R
196		15	33.5		4	<b>HJ2328</b>	1.98	NJ2328	NU2328
196		15	31		4	<b>HJ2328R</b>	2.14	NJ2328R	NU2328R
219		18	33		5	<b>HJ428</b>	3.75	NJ428	NU428
<b>150</b>		193	12	20.5		3	<b>HJ230</b>	1.24	NJ230
	193.7	12	19.5		3	<b>HJ230R</b>	1.26	NJ230R	NU230R
	193	12	26.5		3	<b>HJ2230</b>	1.24	NJ2230	NU2230
	193.7	12	24.5		3	<b>HJ2230R</b>	1.35	NJ2230R	NU2230R
	210	15	26.5		4	<b>HJ330</b>	2.37	NJ330	NU330
	210	15	25		4	<b>HJ330R</b>	2.35	NJ330R	NU330R
	210	15	34		4	<b>HJ2330</b>	2.37	NJ2330	NU2330
	210	15	31.5		4	<b>HJ2330R</b>	2.48	NJ2330R	NU2330R
	234	20	36.5		5	<b>HJ430</b>	4.70	NJ430	NU430
	<b>160</b>	207	12	21		3	<b>HJ232</b>	1.48	NJ232
207.3		12	20		3	<b>HJ232R</b>	1.48	NJ232R	NU232R

$d$	Boundary dimensions (mm)				$r_1$ min.	Thrust collar No.	(Refer.) Mass (kg)	Applicable bearing No.	
	$d_1$	$B_1$	$B_2$					NJ	NU
<b>160</b>	205	12	28		3	<b>HJ2232</b>	1.48	NJ2232	NU2232
	206.1	12	24.5		3	<b>HJ2232R</b>	1.55	NJ2232R	NU2232R
	225	15	28		4	<b>HJ332</b>	2.75	NJ332	NU332
	222.1	15	25		4	<b>HJ332R</b>	2.59	NJ332R	NU332R
	225	15	37		4	<b>HJ2332</b>	2.75	NJ2332	NU2332
	222.1	15	32		4	<b>HJ2332R</b>	2.76	NJ2332R	NU2332R
<b>170</b>	220.5	12	22		4	<b>HJ234</b>	1.70	NJ234	NU234
	220.8	12	20		4	<b>HJ234R</b>	1.70	NJ234R	NU234R
	219	12	29		4	<b>HJ2234</b>	1.70	NJ2234	NU2234
	219.5	12	24		4	<b>HJ2234R</b>	1.79	NJ2234R	NU2234R
	238	16	29.5		4	<b>HJ334</b>	3.25	NJ334	NU334
	238	16	38.5		4	<b>HJ2334</b>	3.25	NJ2334	NU2334
<b>180</b>	230.5	12	22		4	<b>HJ236</b>	1.80	NJ236	NU236
	230.8	12	20		4	<b>HJ236R</b>	1.79	NJ236R	NU236R
	229	12	29		4	<b>HJ2236</b>	1.80	NJ2236	NU2236
	229.5	12	24		4	<b>HJ2236R</b>	1.88	NJ2236R	NU2236R
	252	17	30.5		4	<b>HJ336</b>	3.85	NJ336	NU336
	252	17	40		4	<b>HJ2336</b>	3.85	NJ2336	NU2336
<b>190</b>	244.5	13	23.5		4	<b>HJ238</b>	2.20	NJ238	NU238
	244.5	13	21.5		4	<b>HJ238R</b>	2.19	NJ238R	NU238R
	243	13	31.5		4	<b>HJ2238</b>	2.20	NJ2238	NU2238
	243.2	13	26.5		4	<b>HJ2238R</b>	2.31	NJ2238R	NU2238R
	265	18	32		5	<b>HJ338</b>	4.45	NJ338	NU338
	265	18	41.5		5	<b>HJ2338</b>	4.45	NJ2338	NU2338
<b>200</b>	258	14	25		4	<b>HJ240</b>	2.60	NJ240	NU240
	258.2	14	23		4	<b>HJ240R</b>	2.65	NJ240R	NU240R
	258	14	34		4	<b>HJ2240</b>	2.60	NJ2240	NU2240
	256.9	14	28		4	<b>HJ2240R</b>	2.78	NJ2240R	NU2240R
	280	18	33		5	<b>HJ340</b>	5.00	NJ340	NU340

### Thrust collars for cylindrical roller bearings

$d$  (200) ~ 320 mm

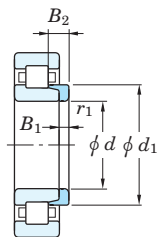

Thrust collar

$d$	Boundary dimensions (mm)				Thrust collar No.	(Refer.) Mass (kg)	Applicable bearing No.	
	$d_1$	$B_1$	$B_2$	$r_1$ min.			NJ	NU
<b>200</b>	280	18	44.5	5	<b>HJ2340</b>	5.00	NJ2340	NU2340
<b>220</b>	286	15	27.5	4	<b>HJ244</b>	3.55	NJ244	NU244
	286	15	36.5	4	<b>HJ2244</b>	3.55	NJ2244	NU2244
	307	20	36	5	<b>HJ344</b>	7.05	NJ344	NU344
<b>240</b>	313	16	29.5	4	<b>HJ248</b>	4.65	NJ248	NU248
	313	16	38.5	4	<b>HJ2248</b>	4.65	NJ2248	NU2248
	335	22	39.5	5	<b>HJ348</b>	8.20	NJ348	NU348
<b>260</b>	340	18	33	5	<b>HJ252</b>	6.20	NJ252	NU252
	340	18	40.5	5	<b>HJ2252</b>	6.20	NJ2252	NU2252
<b>280</b>	360	18	33	5	<b>HJ256</b>	7.15	NJ256	NU256
<b>300</b>	387	20	34.5	5	<b>HJ260</b>	7.40	NJ260	NU260
<b>320</b>	415	21	37	5	<b>HJ264</b>	11.3	NJ264	NU264

Double-row cylindrical roller bearings

$d$  25 ~ (110) mm

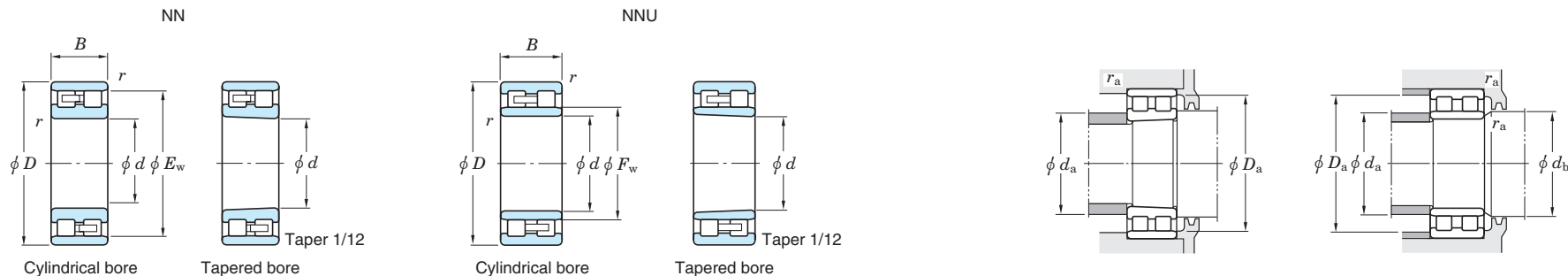

Boundary dimensions (mm)						Basic load ratings (kN)		Limiting speeds (min <sup>-1</sup> )		Bearing No.		Mounting dimensions (mm)						(Refer.) Mass (kg)			
$d$	$D$	$B$	$r_{min.}$	$F_w$	$E_w$	$C_r$	$C_{0r}$	Grease lub.	Oil lub.	NN		NNU		min. $d_a$	max. $d_b$	min. $D_a$	max. $r_a$	Cylindrical bore	Tapered bore		
										Cylindrical bore	Tapered bore	Cylindrical bore	Tapered bore								
25	47	16	0.6	—	41.3	25.7	30.0	14 000	17 000	NN3005	NN3005K	—	—	29	—	—	43	42	0.6	0.127	0.123
30	55	19	1	—	48.5	36.8	44.1	12 000	14 000	NN3006	NN3006K	—	—	35	—	—	50	49	1	0.198	0.192
35	62	20	1	—	55	39.1	50.0	10 000	12 000	NN3007	NN3007K	—	—	40	—	—	57	56	1	0.253	0.246
40	68	21	1	—	61	41.3	55.9	9 100	11 000	NN3008	NN3008K	—	—	45	—	—	63	62	1	0.307	0.298
45	75	23	1	—	67.5	53.4	71.9	8 300	9 900	NN3009	NN3009K	—	—	50	—	—	70	69	1	0.404	0.382
50	80	23	1	—	72.5	52.8	72.6	7 600	9 100	NN3010	NN3010K	—	—	55	—	—	75	74	1	0.429	0.415
55	90	26	1.1	—	81	71.2	101	6 800	8 200	NN3011	NN3011K	—	—	61.5	—	—	83.5	82	1	0.637	0.618
60	95	26	1.1	—	86.1	72.8	106	6 400	7 700	NN3012	NN3012K	—	—	66.5	—	—	88.5	87	1	0.685	0.664
65	100	26	1.1	—	91	74.5	111	6 000	7 200	NN3013	NN3013K	—	—	71.5	—	—	93.5	92	1	0.728	0.705
70	110	30	1.1	—	100	96.9	148	5 500	6 500	NN3014	NN3014K	—	—	76.5	—	—	103.5	101	1	1.04	1.02
75	115	30	1.1	—	105	99.0	155	5 200	6 200	NN3015	NN3015K	—	—	81.5	—	—	108.5	106	1	1.11	1.08
80	125	34	1.1	—	113	119	186	4 800	5 800	NN3016	NN3016K	—	—	86.5	—	—	118.5	114	1	1.55	1.50
85	130	34	1.1	—	118	121	194	4 600	5 500	NN3017	NN3017K	—	—	91.5	—	—	123.5	119	1	1.63	1.58
90	140	37	1.5	—	127	142	228	4 200	5 100	NN3018	NN3018K	—	—	98	—	—	132	129	1.5	2.07	2.01
95	145	37	1.5	—	132	150	246	4 100	4 900	NN3019	NN3019K	—	—	103	—	—	137	134	1.5	2.17	2.10
100	140	40	1.1	113	—	139	258	4 000	4 800	—	—	NNU4920	NNU4920K	106.5	111	115	133.5	—	1	1.95	1.87
	150	37	1.5	—	137	157	265	3 900	4 700	NN3020	NN3020K	—	—	108	—	—	142	139	1.5	2.28	2.21
105	145	40	1.1	118	—	157	306	3 900	4 600	—	—	NNU4921	NNU4921K	111.5	116	120	138.5	—	1	2.00	1.91
	160	41	2	—	146	197	322	3 700	4 400	NN3021	NN3021K	—	—	114	—	—	151	148	2	2.88	2.81
110	150	40	1.1	123	—	163	326	3 700	4 500	—	—	NNU4922	NNU4922K	116.5	121	125	143.5	—	1	2.10	2.01

Double-row cylindrical roller bearings

$d$  (110) ~ (260) mm

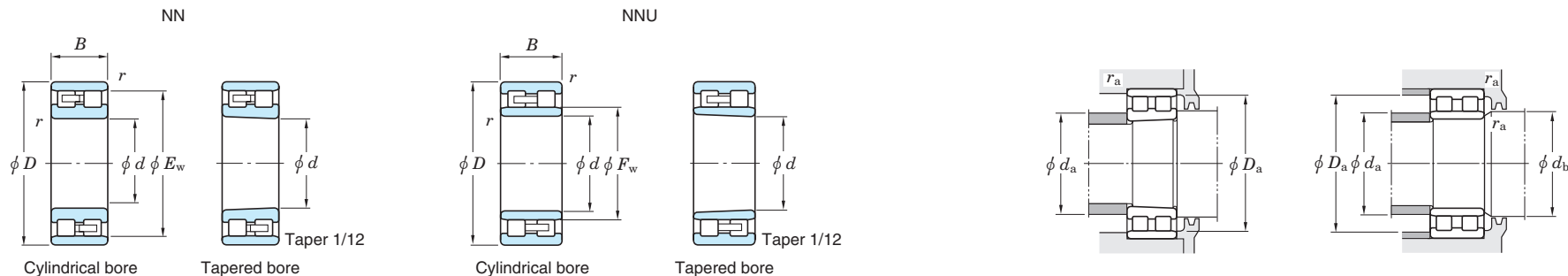

Boundary dimensions (mm)						Basic load ratings (kN)		Limiting speeds (min <sup>-1</sup> )		Bearing No.		Mounting dimensions (mm)						(Refer.) Mass (kg)					
$d$	$D$	$B$	$r_{min.}$	$F_w$	$E_w$	$C_r$	$C_{0r}$	Grease lub.	Oil lub.	NN		NNU		$d_a$ min.	$d_a$ max.	$d_b$ min.	$d_b$ max.	$D_a$ min.	$D_a$ max.	$r_a$ min.	$r_a$ max.	Cylindrical bore	Tapered bore
										Cylindrical bore	Tapered bore	Cylindrical bore	Tapered bore										
110	170	45	2	—	155	221	361	3 500	4 200	<b>NN3022</b>	<b>NN3022K</b>	—	—	119	—	—	161	157	2	—	—	3.65	3.56
120	165	45	1.1	134.5	—	187	373	3 400	4 000	—	—	<b>NNU4924</b>	<b>NNU4924K</b>	126.5	132	137	158.5	—	1	—	—	2.90	2.77
	180	46	2	—	165	232	392	3 200	3 900	<b>NN3024</b>	<b>NN3024K</b>	—	—	129	—	—	171	167	2	—	—	4.00	3.87
130	180	50	1.5	146	—	216	428	3 100	3 700	—	—	<b>NNU4926</b>	<b>NNU4926K</b>	138	143.5	148	172	—	1.5	—	—	3.90	3.73
	200	52	2	—	182	283	476	2 900	3 500	<b>NN3026</b>	<b>NN3026K</b>	—	—	139	—	—	191	183	2	—	—	5.94	5.76
140	190	50	1.5	156	—	222	456	2 900	3 500	—	—	<b>NNU4928</b>	<b>NNU4928K</b>	148	153.5	158	182	—	1.5	—	—	4.15	3.97
	210	53	2	—	192	297	516	2 700	3 300	<b>NN3028</b>	<b>NN3028K</b>	—	—	149	—	—	201	194	2	—	—	6.41	6.21
150	210	60	2	168.5	—	343	692	2 600	3 100	—	—	<b>NNU4930</b>	<b>NNU4930K</b>	159	166	171	201	—	2	—	—	6.50	6.22
	225	56	2.1	—	206	334	587	2 500	3 000	<b>NN3030</b>	<b>NN3030K</b>	—	—	161	—	—	214	208	2	—	—	7.74	7.50
160	220	60	2	178.5	—	340	695	2 500	3 000	—	—	<b>NNU4932</b>	<b>NNU4932K</b>	169	176	182	211	—	2	—	—	6.95	6.65
	240	60	2.1	—	219	398	695	2 400	2 800	<b>NN3032</b>	<b>NN3032K</b>	—	—	171	—	—	229	221	2	—	—	9.38	9.08
170	230	60	2	188.5	—	361	763	2 300	2 800	—	—	<b>NNU4934</b>	<b>NNU4934K</b>	179	186	192	221	—	2	—	—	7.20	6.88
	260	67	2.1	—	236	471	824	2 200	2 600	<b>NN3034</b>	<b>NN3034K</b>	—	—	181	—	—	249	238	2	—	—	12.8	12.4
180	250	69	2	202	—	458	964	2 100	2 600	—	—	<b>NNU4936</b>	<b>NNU4936K</b>	189	199.5	205	241	—	2	—	—	10.5	10.1
	280	74	2.1	—	255	561	958	2 000	2 400	<b>NN3036</b>	<b>NN3036K</b>	—	—	191	—	—	269	257	2	—	—	16.8	16.3
190	260	69	2	210	—	465	996	2 000	2 400	—	—	<b>NNU4938</b>	<b>NNU4938K</b>	199	207	215	251	—	2	—	—	11.0	10.5
	290	75	2.1	—	265	598	1 020	1 900	2 300	<b>NN3038</b>	<b>NN3038K</b>	—	—	201	—	—	279	267	2	—	—	17.6	17.1
200	280	80	2.1	223	—	509	1 050	1 900	2 300	—	—	<b>NNU4940</b>	<b>NNU4940K</b>	211	219.5	228	269	—	2	—	—	15.4	14.7
	310	82	2.1	—	282	638	1 120	1 700	2 100	<b>NN3040</b>	<b>NN3040K</b>	—	—	211	—	—	299	285	2	—	—	22.5	21.8
220	300	80	2.1	244	—	561	1 220	1 700	2 000	—	—	<b>NNU4944</b>	<b>NNU4944K</b>	231	241	248	289	—	2	—	—	16.7	16.0
	340	90	3	—	310	752	1 370	1 600	1 900	<b>NN3044</b>	<b>NN3044K</b>	—	—	233	—	—	327	313	2.5	—	—	29.3	28.4
240	320	80	2.1	263	—	588	1 340	1 600	1 900	—	—	<b>NNU4948</b>	<b>NNU4948K</b>	251	260	269	309	—	2	—	—	18.0	17.2
	360	92	3	—	330	864	1 590	1 400	1 700	<b>NN3048</b>	<b>NN3048K</b>	—	—	253	—	—	347	333	2.5	—	—	32.8	31.8
260	360	100	2.1	287	—	941	2 050	1 400	1 700	—	—	<b>NNU4952</b>	<b>NNU4952K</b>	271	284	296	349	—	2	—	—	31.4	30.0

Double-row cylindrical roller bearings

$d$  (260) ~ 480 mm

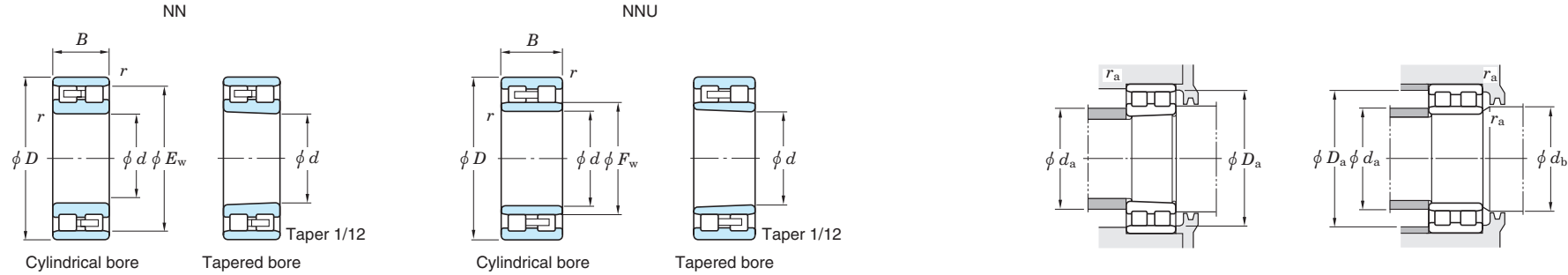

Boundary dimensions (mm)						Basic load ratings (kN)		Limiting speeds (min <sup>-1</sup> )		Bearing No.		Mounting dimensions (mm)						(Refer.) Mass (kg)					
$d$	$D$	$B$	$r_{min.}$	$F_w$	$E_w$	$C_r$	$C_{0r}$	Grease lub.	Oil lub.	NN		NNU		min. $d_a$	max. $d_a$	min. $d_b$	max. $d_b$	min. $D_a$	max. $D_a$	$r_a$ min.	$r_a$ max.	Cylindrical bore	Tapered bore
										Cylindrical bore	Tapered bore	Cylindrical bore	Tapered bore										
260	400	104	4	—	364	1 030	1 830	1 300	1 500	<b>NN3052</b>	<b>NN3052K</b>	—	—	276	—	—	384	367	3	—	—	47.4	46.0
	420	106	4	—	384	1 090	2 010	1 200	1 400	<b>NN3056</b>	<b>NN3056K</b>	—	—	291	305	316	369	—	2	—	—	33.1	31.6
300	420	118	3	339	—	1 170	2 720	1 100	1 300	—	—	<b>NNU4956</b>	<b>NNU4956K</b>	291	305	316	369	—	2	—	—	33.1	31.6
	460	118	4	—	418	1 290	2 460	1 100	1 300	<b>NN3060</b>	<b>NN3060K</b>	—	—	296	—	—	404	387	3	—	—	51.2	49.6
320	440	118	3	352	—	1 220	2 750	1 100	1 300	—	—	<b>NNU4960</b>	<b>NNU4960K</b>	313	335	343	407	—	2.5	—	—	51.9	49.7
	480	121	4	—	438	1 350	2 670	980	1 200	<b>NN3064</b>	<b>NN3064K</b>	—	—	316	—	—	444	421	3	—	—	70.8	68.7
340	440	118	3	372	—	1 220	2 750	1 100	1 300	—	—	<b>NNU4964</b>	<b>NNU4964K</b>	333	348	363	427	—	2.5	—	—	53.7	51.4
	520	133	5	—	473	1 580	3 090	880	1 100	<b>NN3068</b>	<b>NN3068K</b>	—	—	336	—	—	464	442	3	—	—	76.4	74.0
360	460	118	3	372	—	1 270	2 930	990	1 200	—	—	<b>NNU4968</b>	<b>NNU4968K</b>	353	368	383	447	—	2.5	—	—	56.8	54.3
	520	133	5	—	473	1 580	3 090	880	1 100	<b>NN3068</b>	<b>NN3068K</b>	—	—	360	—	—	500	477	4	—	—	101	97.8
360	540	134	5	—	493	1 560	3 090	830	990	<b>NN3072</b>	<b>NN3072K</b>	—	—	380	—	—	520	497	4	—	—	107	104
380	560	135	5	—	510	1 650	3 350	780	940	<b>NN3076</b>	<b>NN3076K</b>	—	—	400	—	—	540	514	4	—	—	113	109
400	600	148	5	—	548	2 030	4 140	700	850	<b>NN3080</b>	<b>NN3080K</b>	—	—	420	—	—	580	552	4	—	—	146	141
420	620	150	5	—	570	2 310	4 570	670	800	<b>NN3084</b>	<b>NN3084K</b>	—	—	440	—	—	600	574	4	—	—	154	149
440	650	157	6	—	597	2 520	5 060	620	740	<b>NN3088</b>	<b>NN3088K</b>	—	—	464	—	—	626	602	5	—	—	177	171
460	680	163	6	—	627	2 700	5 480	570	690	<b>NN3092</b>	<b>NN3092K</b>	—	—	484	—	—	656	632	5	—	—	201	195
480	700	165	6	—	642	2 770	5 710	540	650	<b>NN3096</b>	<b>NN3096K</b>	—	—	504	—	—	676	647	5	—	—	211	204

## Tapered roller bearings

Tapered roller bearings are designed such that outer ring, inner ring and rollers have tapered surfaces whose apexes converge at a common point on the bearing axis. Along with metric series bearings, inch series bearings are also available. This type of bearing is suitable for applications that involve heavy or impact loading.

### Single-row tapered roller bearings

- Able to carry radial and axial load in one direction simultaneously. Because an axial component of force is produced when this type of bearing is loaded radially, two bearings are used together facing one another, or two or more bearings are matched and used.
- There are the standard, medium and steep type which are different in contact angle size. Medium-tapered metric series bearings are identified by the supplementary code "C" which is added as a suffix to bearing numbers.
- Bearings whose outer ring width, outer ring small inside diameter and contact angle are determined in accordance with ISO 355 specifications are identified by the supplementary code "J" as a suffix. Inner ring assemblies and the outer rings of such bearings are interchangeable with those of bearings produced abroad if the bearing numbers are the same.

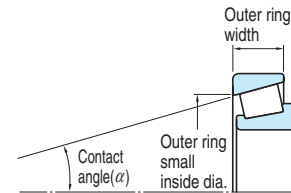

ISO sub-unit specifications

### Double-row tapered roller bearings

- These bearings are divided into the TDO type which has one double outer ring and two single-row inner rings, and the TDI type which has two single-row outer rings and one double inner ring. Both accommodate radial and axial loading in both directions. These two also carry moment loads, however, the TDO type is superior to the TDI type, because the distance between load centers ( $\alpha$ ) is longer in the TDO type.
- The spacer of the TDO type, or the TDI type, pre-adjusts the internal clearance to provide proper operating clearance after mounting.

### Single-row tapered roller bearings



Metric series

Bore diameter **15 – 360 mm**



Inch series

(including J series metric bearing)

Bore diameter **9.525 – 292.100 mm**

### Double-row tapered roller bearings

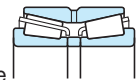

TDO type

Bore diameter **25 – 500 mm**

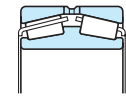

TDI type

Bore diameter **100 – 500 mm**

[Note] When supplementary code "J" is added as a prefix (not a suffix) to bearing numbers (e.g. JHM720249/JHM720210), the bearings are not designed according to ISO 355. Such bearings are called "J series metric tapered roller bearings," and are produced according to special tolerances.





Boundary dimensions	Metric single-row tapered roller bearings : as specified in JIS B 1512.																																								
	<p><b>Reference</b> JIS B 1512 specifies new dimension series which are based on ISO 355, as well as the conventional "3XX" dimension series. These new dimension series are as follows :</p> <p style="text-align: center;"><b>New dimension series</b></p> <div style="display: flex; justify-content: space-around;"> <div style="text-align: center;"> <p><b>(1) Angle series</b></p> <table border="1"> <thead> <tr> <th rowspan="2">Angle series</th> <th colspan="2">Contact angle <math>\alpha</math></th> </tr> <tr> <th>over</th> <th>up to</th> </tr> </thead> <tbody> <tr><td>2</td><td>10°</td><td>13° 52'</td></tr> <tr><td>3</td><td>13° 52'</td><td>15° 59'</td></tr> <tr><td>4</td><td>15° 59'</td><td>18° 55'</td></tr> <tr><td>5</td><td>18° 55'</td><td>23°</td></tr> <tr><td>6</td><td>23°</td><td>27°</td></tr> <tr><td>7</td><td>27°</td><td>30°</td></tr> </tbody> </table> </div> <div style="text-align: center;"> <p><b>(3) Width series</b></p> <table border="1"> <thead> <tr> <th rowspan="2">Width series</th> <th colspan="2"><math>T/\{(D-d)^{0.95}\}</math></th> </tr> <tr> <th>over</th> <th>up to</th> </tr> </thead> <tbody> <tr><td>B</td><td>0.50</td><td>0.68</td></tr> <tr><td>C</td><td>0.68</td><td>0.80</td></tr> <tr><td>D</td><td>0.80</td><td>0.88</td></tr> <tr><td>E</td><td>0.88</td><td>1.00</td></tr> </tbody> </table> </div> </div>	Angle series	Contact angle $\alpha$		over	up to	2	10°	13° 52'	3	13° 52'	15° 59'	4	15° 59'	18° 55'	5	18° 55'	23°	6	23°	27°	7	27°	30°	Width series	$T/\{(D-d)^{0.95}\}$		over	up to	B	0.50	0.68	C	0.68	0.80	D	0.80	0.88	E	0.88	1.00
	Angle series		Contact angle $\alpha$																																						
		over	up to																																						
2	10°	13° 52'																																							
3	13° 52'	15° 59'																																							
4	15° 59'	18° 55'																																							
5	18° 55'	23°																																							
6	23°	27°																																							
7	27°	30°																																							
Width series	$T/\{(D-d)^{0.95}\}$																																								
	over	up to																																							
B	0.50	0.68																																							
C	0.68	0.80																																							
D	0.80	0.88																																							
E	0.88	1.00																																							
<p><b>(2) Diameter series</b></p> <table border="1"> <thead> <tr> <th rowspan="2">Diameter series</th> <th colspan="2"><math>D/(d^{0.77})</math></th> </tr> <tr> <th>over</th> <th>up to</th> </tr> </thead> <tbody> <tr><td>B</td><td>3.40</td><td>3.80</td></tr> <tr><td>C</td><td>3.80</td><td>4.40</td></tr> <tr><td>D</td><td>4.40</td><td>4.70</td></tr> <tr><td>E</td><td>4.70</td><td>5.00</td></tr> <tr><td>F</td><td>5.00</td><td>5.60</td></tr> <tr><td>G</td><td>5.60</td><td>7.00</td></tr> </tbody> </table>	Diameter series	$D/(d^{0.77})$		over	up to	B	3.40	3.80	C	3.80	4.40	D	4.40	4.70	E	4.70	5.00	F	5.00	5.60	G	5.60	7.00	<p>[Remarks]</p> <p>1. Combine these series symbols in the listed order to make the dimension series numbers. (ex. 2BC)</p> <p>2. Bearing numbers consist of a dimension series number and a bore diameter which is added as a suffix. (ex. 2BC080 : bore diameter 80 mm)</p>																	
Diameter series		$D/(d^{0.77})$																																							
	over	up to																																							
B	3.40	3.80																																							
C	3.80	4.40																																							
D	4.40	4.70																																							
E	4.70	5.00																																							
F	5.00	5.60																																							
G	5.60	7.00																																							
Tolerances	<ul style="list-style-type: none"> <li>· Metric series single-row tapered roller bearings as specified in JIS B 1514-1. .... (refer to Table 7-5 on pp. A 60 – A 62.)</li> <li>· Metric series double-row tapered roller bearings as specified in BAS 1002. .... (refer to Table 7-6 on p. A 63.)</li> <li>· Inch series tapered roller bearings as specified in ABMA Section 19. .... (refer to Table 7-7 on pp. A 64, 65.)</li> <li>· J series metric tapered roller bearings the tolerance is specified separately. .... (refer to Table 7-8 on pp. A 66, 67.)</li> </ul>																																								
Internal clearance	Radial internal clearance of double-row, four-row and matched pair tapered roller bearings ..... (refer to Table 10-10 on p. A 104.)																																								
Recommended fits	<ul style="list-style-type: none"> <li>· Metric series tapered roller bearings (classes 0, 6X and 6) ..... (refer to Table 9-4 on pp. A 85, 86.)</li> <li>· Inch series tapered roller bearings ..... (refer to Table 9-7 on pp. A 90, 91.)</li> <li>· J series metric tapered roller bearings ..... (refer to Table 9-6 on pp. A 88, 89.)</li> </ul>																																								
Standard cage	Pressed steel cage (supplementary code : //) ( Some large size bearings have a pin type cage (FP) instead. ) ( They are listed separately in the bearing specification table. )																																								

Allowable misalignment	Single-row tapered roller bearings : 0.000 9 rad (3') (If the misalignment exceeds this angle size, JTEKT is ready to design special bearings to order.)
Equivalent radial load	<p>■ Single-row tapered roller bearings</p> <p>Dynamic equivalent radial load <math>\left( \text{when } \frac{F_a}{F_r} \leq e \right) P_r = F_r</math>  <math>\left( \text{when } \frac{F_a}{F_r} &gt; e \right) P_r = 0.4F_r + Y_1 F_a</math></p> <p>Static equivalent radial load <math>P_{0r} = 0.5F_r + Y_0 F_a</math>          when <math>P_{0r} &lt; F_r, P_{0r} = F_r</math></p> <p>[Note] Refer to the bearing specification table for the values of axial load factors <math>Y_1, Y_2, Y_3</math> and <math>Y_0</math> and constant <math>e</math>.</p> <p>■ Double-row or four-row tapered roller bearings</p> <p>Dynamic equivalent radial load <math>\left( \text{when } \frac{F_a}{F_r} \leq e \right) P_r = F_r + Y_2 F_a</math>  <math>\left( \text{when } \frac{F_a}{F_r} &gt; e \right) P_r = 0.67F_r + Y_3 F_a</math></p> <p>Static equivalent radial load <math>P_{0r} = F_r + Y_0 F_a</math></p>
[Remarks]	<p>1. When two single-row tapered roller bearings are used together facing one another, an axial component of force is produced under radial load. In this case, refer to pp. A 34, 35 for calculation of the dynamic equivalent radial load.</p> <p>2. When the load is too small, slippage occurs between the rollers and raceways, causing smearing to develop. This also occurs to matched pair bearings when the ratio of axial load to radial load exceeds the value <math>e</math> shown in the specification table (<math>F_a / F_r &gt; e</math>). Consult with JTEKT on use of bearings under such conditions.</p>

Single-row tapered roller bearings  
metric series

d 15 ~ 22 mm

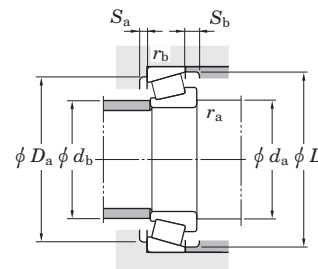
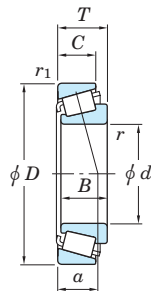

Boundary dimensions (mm)							Basic load ratings (kN)		Limiting speeds (min <sup>-1</sup> )		Bearing No. <sup>1)</sup>	Dimension series to ISO355 (Refer.)	Load center (mm) a	Mounting dimensions (mm)								Constant e	Axial load factors		(Refer.) Mass (kg)	
d	D	T	B	C	r min.	r1 min.	C <sub>r</sub>	C <sub>0r</sub>	Grease lub.	Oil lub.				d <sub>a</sub> min.	d <sub>b</sub> max.	D <sub>a</sub> max.	D <sub>b</sub> min.	S <sub>a</sub> min.	S <sub>b</sub> min.	r <sub>a</sub> max.	r <sub>b</sub> max.		Y <sub>1</sub>	Y <sub>0</sub>		
15	35	11.75	11	10	0.6	0.6	15.8	14.5	12 000	16 000	30202R 30302JR	—	8.3	19.5	20	30.5	29	33	2	1.7	0.6	0.6	0.32	1.88	1.04	0.054
	42	14.25	13	11	1	1	21.9	19.2	10 000	14 000		2FB	10.0	20.5	22	36.5	35	38	2	3	1	1	0.29	2.11	1.16	0.098
17	40	13.25	12	11	1	1	20.8	20.7	10 000	14 000	30203JR 32203JR	2DB	10.1	22.5	23	34.5	33	37	2	2	1	1	0.35	1.74	0.96	0.081
	40	17.25	16	14	1	1	27.4	27.5	10 000	14 000		2DD	11.4	22.5	23	34.5	33	37	2	3	1	1	0.31	1.92	1.06	0.104
	47	15.25	14	12	1	1	27.4	24.5	9 200	12 000	30303JR 30303R	2FB	11.0	22.5	25	41.5	40	42	2	3	1	1	0.29	2.11	1.16	0.133
	47	15.25	14	12	1	1	27.4	24.5	9 200	12 000		—	10.5	22.5	25	41.5	40	42	2	3	1	1	0.28	2.11	1.16	0.127
	47	20.25	19	16	1	1	31.9	29.9	9 400	13 000	32303 32303JR	—	12.4	22.5	25	41.5	39	43	2	4	1	1	0.28	2.11	1.16	0.170
	47	20.25	19	16	1	1	36.6	35.9	9 400	13 000		2FD	12.2	22.5	25	41.5	39	43	2	4	1	1	0.29	2.11	1.16	0.176
20	42	15	15	12	0.6	0.6	27.3	31.5	9 700	13 000	32004JR 57008R	3CC	10.5	24.5	25	37.5	35	39	3	3	0.6	0.6	0.37	1.60	0.88	0.102
	47	15.25	14	12	1	1	25.8	25.5	9 000	12 000		—	12.9	25.5	26	41.5	37	44	2	3	1	1	0.52	1.16	0.64	0.125
	47	15.25	14	12	1	1	27.0	27.2	8 700	12 000	30204JR 32204JR	2DB	11.8	25.5	27	41.5	39	44	2	3	1	1	0.35	1.74	0.96	0.127
	47	19.25	18	15	1	1	33.1	34.7	8 900	12 000		2DD	12.5	25.5	27	41.5	39	43	2	4	1	1	0.33	1.81	1.00	0.159
	47	19.25	18	16	1	1	33.3	37.0	9 100	12 000	32204XR 30304AC	—	15.3	25.5	25	41.5	35	45	2	3	1	1	0.55	1.10	0.60	0.170
	52	16.25	16	12	1.5	1.5	30.5	28.4	8 300	11 000		—	13.5	28.5	28	43.5	42	49	4	4	1.5	1.5	0.55	1.10	0.60	0.170
	52	16.25	16	13	1.5	1.5	36.2	35.1	8 300	11 000	30304AJR 32304CR 32304JR	—	11.1	28.5	28	44	44	47	2	3	1.5	1.5	0.30	2.00	1.10	0.179
	52	22.25	21	18	1.5	1.5	41.8	44.9	8 600	12 000		—	16.5	28.5	25	43.5	37	48	3	4	1.5	1.5	0.55	1.10	0.60	0.250
	52	22.25	21	18	1.5	1.5	45.1	46.7	8 400	11 000		2FD	14.4	28.5	27	43.5	43	47	3	4	1.5	1.5	0.30	2.00	1.10	0.244
22	44	15	15	11.5	0.6	0.6	28.3	33.6	9 100	12 000	320/22JR T2CC022	3CC	11.0	26.5	27	39.5	38	41	3	3.5	0.6	0.6	0.40	1.51	0.83	0.108
	47	17	17.5	13.5	1	1	32.7	35.9	8 700	12 000		2CC	11.3	27.5	28	41.5	40	44	4	3.5	1	1	0.33	1.79	0.99	0.138
	50	15.25	14	12	1	1	29.2	28.6	8 400	11 000	302/22CR 302/22R	—	13.9	27.5	28	44.5	40	47	2	3	1	1	0.55	1.10	0.60	0.140
	50	15.25	14	12	1	1	29.3	30.9	8 100	11 000		—	12.2	27.5	30	44.5	41	46	2	3	1	1	0.37	1.60	0.88	0.144
	50	19.25	18	15	1	1	35.1	39.1	8 400	11 000	322/22CR 322/22R	—	15.5	27.5	28	44.5	38	47	2	4	1	1	0.55	1.10	0.60	0.170
	50	19.25	18	15	1	1	36.8	41.6	8 100	11 000		—	14.0	27.5	29	44.5	41	46	2	4	1	1	0.37	1.60	0.88	0.178
	56	17.25	16	13	1.5	1.5	36.3	36.6	7 700	10 000	303/22XR 303/22R	—	15.7	30.5	31	47.5	44	52	3	4	1.5	1.5	0.59	1.02	0.56	0.210
	56	17.25	16	14	1.5	1.5	41.7	41.1	7 500	10 000		—	12.2	30.5	32	47.5	47	51	2	3	1.5	1.5	0.31	1.97	1.08	0.216
	56	22.25	21	17	1.5	1.5	48.3	50.6	8 000	11 000	323/22CR 323/22R	—	16.9	30.5	28	47.5	41	52	3	5	1.5	1.5	0.55	1.10	0.60	0.290
	56	22.25	21	18	1.5	1.5	50.6	52.7	7 600	10 000		—	14.6	30.5	31	47.5	46	51	3	4	1.5	1.5	0.31	1.97	1.08	0.273

[Note] 1) Please consult with JTEKT when using the bearings identified by suffix C. They are medium-tapered types especially designed for special purposes.

Single-row tapered roller bearings  
metric series

d 25 ~ (30) mm

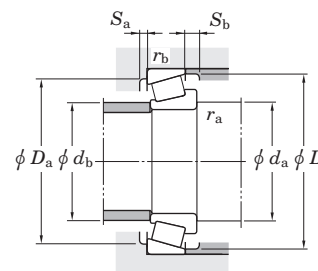
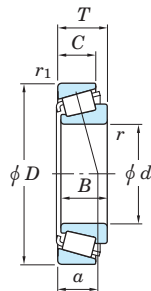

Boundary dimensions (mm)							Basic load ratings (kN)		Limiting speeds (min <sup>-1</sup> )		Bearing No. <sup>1)</sup>	Dimension series to ISO355 (Refer.)	Load center (mm) a	Mounting dimensions (mm)								Constant e	Axial load factors		(Refer.) Mass (kg)	
d	D	T	B	C	r min.	r1 min.	C <sub>r</sub>	C <sub>0r</sub>	Grease lub.	Oil lub.				d <sub>a</sub> min.	d <sub>b</sub> max.	D <sub>a</sub> max.	D <sub>b</sub> min.	S <sub>a</sub> min.	S <sub>b</sub> min.	r <sub>a</sub> max.	r <sub>b</sub> max.		Y <sub>1</sub>	Y <sub>0</sub>		
25	47	15	15	11.5	0.6	0.6	30.2	37.7	8 300	11 000	32005JR	4CC	11.8	29.5	30	42.5	40	44	3	3.5	0.6	0.6	0.43	1.39	0.77	0.118
	47	17	17	14	0.6	0.6	33.5	42.3	8 300	11 000	33005JR	2CE	10.9	29.5	30	42.5	41	44	3	3	0.6	0.6	0.29	2.07	1.14	0.131
	52	16.25	15	12	1	1	30.4	32.4	7 900	11 000	30205XR	—	14.9	30.5	30	46.5	41	49	2	4	1	1	0.58	1.04	0.57	0.155
	52	16.25	15	13	1	1	31.5	33.7	7 800	10 000	30205JR	3CC	12.9	30.5	31	46.5	44	48	2	3	1	1	0.37	1.60	0.88	0.156
	52	19.25	18	16	1	1	36.4	43.2	7 900	11 000	32205XR	—	16.2	30.5	30	46.5	40	50	2	3	1	1	0.55	1.10	0.60	0.200
	52	19.25	18	16	1	1	39.8	44.8	7 900	11 000	32205JR	2CD	13.5	30.5	31	46.5	43	48	2	4	1	1	0.36	1.67	0.92	0.188
	52	22	22	18	1	1	48.9	58.5	7 900	10 000	33205JR	2DE	14.1	30.5	30	46.5	43	49	4	4	1	1	0.35	1.71	0.94	0.225
	62	18.25	17	13	1.5	1.5	39.8	42.5	5 700	8 000	30305DJR	7FB	20.4	33.5	34	53.5	47	58.5	3	5	1.5	1.5	0.83	0.73	0.40	0.269
	62	18.25	17	14	1.5	1.5	45.0	45.8	6 700	9 000	TR0506R	—	16.3	33.5	35	53.5	50	58	3	4	1.5	1.5	0.55	1.10	0.60	0.275
	62	18.25	17	15	1.5	1.5	48.2	46.9	6 800	9 000	30305JR	2FB	12.9	33.5	34	54	54	57	2	3	1.5	1.5	0.30	2.00	1.10	0.273
	62	25.25	24	19	1.5	1.5	57.2	65.8	7 000	9 300	32305XR	—	18.9	33.5	33	53.5	46	58	3	6	1.5	1.5	0.55	1.10	0.60	0.390
	62	25.25	24	20	1.5	1.5	61.2	64.1	6 900	9 100	32305JR	2FD	16.6	33.5	33	53.5	52	57	3	5	1.5	1.5	0.30	2.00	1.10	0.386
	28	52	16	16	12	1	1	35.2	44.0	7 500	10 000	320/28JR	4CC	12.7	33.5	33	46.5	45	49	3	4	1	1	0.43	1.39	0.77
58		17.25	16	13	1	1	38.8	41.7	7 000	9 300	302/28CR	—	16.0	33.5	34	52.5	47	55	2	4	1	1	0.55	1.10	0.60	0.205
58		17.25	16	14	1	1	38.8	42.0	7 000	9 300	302/28R	—	13.4	33.5	35	52.5	49	54	2	3	1	1	0.37	1.60	0.88	0.209
58		20.25	19	16	1	1	44.9	54.1	7 100	9 400	322/28CR	—	17.0	33.5	33	52.5	45	55	3	4	1	1	0.55	1.10	0.60	0.255
58		20.25	19	16	1	1	49.2	55.2	6 900	9 100	322/28R	—	15.0	33.5	35	52.5	49	54.5	2	4	1	1	0.37	1.60	0.88	0.244
58		24	24	19	1	1	57.6	69.5	7 000	9 300	332/28JR	2DE	15.4	33.5	34	52.5	49	55	4	5	1	1	0.34	1.77	0.97	0.302
68		19.75	18	14	1.5	1.5	51.7	50.2	6 200	8 200	303/28CR	—	17.8	36.5	37	59.5	55	64	3	4.5	1.5	1.5	0.55	1.10	0.60	0.332
68		19.75	18	16	1.5	1.5	53.5	54.0	6 100	8 200	303/28R	—	14.9	36.5	38	59.5	58	63	2	3.5	1.5	1.5	0.32	1.88	1.04	0.345
68		25.75	24	20	1.5	1.5	66.5	72.9	6 300	8 500	323/28CR	—	20.5	36.5	35	59.5	51	64	3	5.5	1.5	1.5	0.55	1.10	0.60	0.480
68	25.75	24	21	1.5	1.5	69.6	75.6	6 100	8 100	323/28R	—	17.6	36.5	38	59.5	57	63	3	4.5	1.5	1.5	0.32	1.88	1.04	0.469	
30	55	17	17	13	1	1	38.2	48.0	7 000	9 400	32006JR	4CC	13.6	35.5	35	49.5	47	52	3	4	1	1	0.43	1.39	0.77	0.177
	55	20	20	16	1	1	43.2	55.2	7 000	9 400	33006JR	2CE	13.0	35.5	36	49.5	48	52	3	4	1	1	0.29	2.06	1.13	0.203
	62	17.25	16	13	1	1	42.3	45.1	6 500	8 700	30206CR	—	16.5	35.5	36	56.5	51	59	2	4	1	1	0.55	1.10	0.60	0.230
	62	17.25	16	14	1	1	41.5	44.8	6 500	8 700	30206JR	3DB	14.1	35.5	37	56.5	53	57	2	3	1	1	0.37	1.60	0.88	0.236
	62	21.25	20	16	1	1	51.7	59.0	6 600	8 900	32206XR	—	18.0	35.5	36	56.5	49	59	3	5	1	1	0.55	1.10	0.60	0.300

[Note] 1) Please consult with JTEKT when using the bearings identified by suffix C. They are medium-tapered types especially designed for special purposes.

Single-row tapered roller bearings  
metric series

d (30) ~ (35) mm

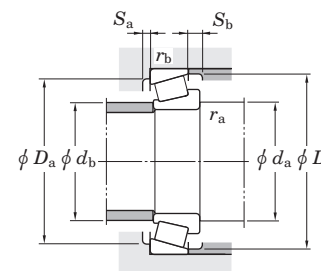
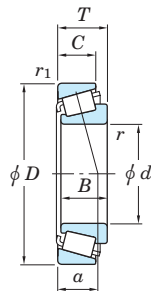

Boundary dimensions (mm)							Basic load ratings (kN)		Limiting speeds (min <sup>-1</sup> )		Bearing No. <sup>1)</sup>	Dimension series to ISO355 (Refer.)	Load center (mm) a	Mounting dimensions (mm)								Constant e	Axial load factors		(Refer.) Mass (kg)	
d	D	T	B	C	r min.	r1 min.	Cr	C0r	Grease lub.	Oil lub.				da min.	db max.	Da max.	Db min.	Sa min.	Sb min.	ra max.	rb max.		Y1	Y0		
30	62	21.25	20	17	1	1	50.7	57.9	6 500	8 700	32206JR	3DC	15.9	35.5	37	56.5	52	58	2	4	1	1	0.37	1.60	0.88	0.292
	62	25	25	19.5	1	1	66.4	79.4	6 500	8 700	33206JR	2DE	16.3	35.5	36	56.5	53	59	5	5.5	1	1	0.34	1.76	0.97	0.359
	72	20.75	19	14	1.5	1.5	50.9	54.9	4 900	6 800	30306DJR	7FB	23.7	38.5	40	63.5	55	68	3	6.5	1.5	1.5	0.83	0.73	0.40	0.400
	72	20.75	19	16	1.5	1.5	56.9	55.6	5 900	7 900	TRA0607R	—	18.6	38.5	39	63.5	58	68	3	4.5	1.5	1.5	0.55	1.10	0.60	0.405
	72	20.75	19	16	1.5	1.5	59.6	60.1	5 800	7 700	30306JR	2FB	15.7	38.5	40	63.5	62	66	3	4.5	1.5	1.5	0.31	1.90	1.05	0.411
	72	28.75	27	23	1.5	1.5	80.0	93.8	6 000	8 000	32306CR	5FD	22.0	38.5	37	63.5	54	68	3	5.5	1.5	1.5	0.55	1.10	0.60	0.610
	72	28.75	27	23	1.5	1.5	82.2	91.6	5 900	7 900	32306JR	2FD	18.9	38.5	39	63.5	59	66	3	5.5	1.5	1.5	0.31	1.90	1.05	0.588
	32	58	17	17	13	1	1	39.2	50.6	6 700	8 900	320/32JR	4CC	14.3	37.5	38	52.5	50	55	3	4	1	1	0.45	1.32	0.73
65		18.25	17	14	1	1	47.5	51.5	6 200	8 300	302/32CR	—	17.2	37.5	38	59.5	53	62	3	4	1	1	0.55	1.10	0.60	0.275
65		18.25	17	15	1	1	48.0	51.4	6 200	8 200	302/32R	—	14.9	37.5	39	59.5	55	61	3	3	1	1	0.37	1.60	0.88	0.266
65		22.25	21	17	1	1	55.8	65.1	6 300	8 400	322/32CR	—	18.7	37.5	37	59.5	51	62	3	5	1	1	0.55	1.10	0.60	0.340
65		22.25	21	18	1	1	51.6	57.7	6 200	8 200	322/32	—	16.3	37.5	40	59.5	55	61	2	4	1	1	0.37	1.60	0.88	0.330
65		26	26	20.5	1	1	71.8	86.9	6 200	8 300	332/32JR	2DE	16.9	37.5	38	59.5	55	62	5	5.5	1	1	0.35	1.73	0.95	0.404
75		21.75	20	16	1.5	1.5	63.4	66.3	5 600	7 400	303/32CR	—	19.7	40.5	42	66.5	60	70	3	5.5	1.5	1.5	0.55	1.10	0.60	0.465
75		21.75	20	18	1.5	1.5	64.4	65.6	5 500	7 300	303/32R	—	16.0	40.5	43	66.5	64	70	3	3.5	1.5	1.5	0.32	1.88	1.04	0.461
75		29.75	28	23	1.5	1.5	75.1	87.1	5 600	7 400	TR0608A	5FD	23.7	40.5	41	66.5	57	71	3	6.5	1.5	1.5	0.55	1.10	0.60	0.649
75		29.75	28	25	1.5	1.5	89.6	101	5 600	7 400	323/32R	—	19.6	40.5	42	66.5	63	69	3	4.5	1.5	1.5	0.32	1.88	1.04	0.650
35	55	14	14	11.5	0.6	0.6	26.1	36.5	6 600	8 800	32907JR-2	2BD	10.9	39.5	40	50.5	49	52	2.5	2.5	0.6	0.6	0.29	2.06	1.13	0.120
	62	18	18	14	1	1	45.5	59.4	6 200	8 200	32007JR	4CC	15.1	40.5	40	56.5	54	59	4	4	1	1	0.45	1.32	0.73	0.231
	62	21	20	16	1	1	40.8	53.8	6 200	8 200	33007	—	14.8	40.5	41	56.5	55	59	3	4	1	1	0.33	1.80	0.99	0.250
	62	21	21	17	1	1	51.3	68.0	6 200	8 200	33007JR	2CE	14.2	40.5	41	56.5	55	59	3	4	1	1	0.31	1.97	1.08	0.263
	72	18.25	17	15	1.5	1.5	52.9	56.2	5 700	7 600	30207CR	—	17.9	43.5	43	63.5	59	68	3	3	1.5	1.5	0.55	1.10	0.60	0.350
	72	18.25	17	15	1.5	1.5	55.1	60.9	5 600	7 400	30207JR	3DB	15.3	43.5	44	63.5	62	67	3	3	1.5	1.5	0.37	1.60	0.88	0.344
	72	24.25	23	19	1.5	1.5	69.0	86.6	5 700	7 600	32207-1R	—	21.1	43.5	42	63.5	56	68	3	5	1.5	1.5	0.58	1.04	0.57	0.465
	72	24.25	23	19	1.5	1.5	69.6	82.4	5 600	7 500	32207JR	3DC	18.2	43.5	43	63.5	61	67	3	5	1.5	1.5	0.37	1.60	0.88	0.453
	72	28	28	22	1.5	1.5	87.6	107	5 700	7 500	33207JR	2DE	18.4	43.5	42	63.5	61	68	5	6	1.5	1.5	0.35	1.70	0.93	0.551
	80	22.75	21	15	2	1.5	63.1	69.1	4 300	6 000	30307DJR	7FB	26.8	45	44	70	66	76.5	3	7.5	2	1.5	0.83	0.73	0.40	0.536

[Note] 1) Please consult with JTEKT when using the bearings identified by suffix C. They are medium-tapered types especially designed for special purposes.

Single-row tapered roller bearings  
metric series

d (35) ~ (45) mm

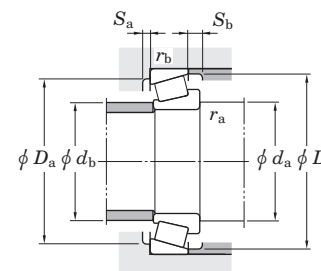
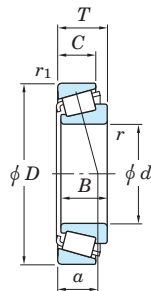

Boundary dimensions (mm)							Basic load ratings (kN)		Limiting speeds (min <sup>-1</sup> )		Bearing No. <sup>1)</sup>	Dimension series to ISO355 (Refer.)	Load center (mm) a	Mounting dimensions (mm)								Constant e	Axial load factors		(Refer.) Mass (kg)	
d	D	T	B	C	r min.	r1 min.	C <sub>r</sub>	C <sub>0r</sub>	Grease lub.	Oil lub.				d <sub>a</sub> min.	d <sub>b</sub> max.	D <sub>a</sub> max.	D <sub>b</sub> min.	S <sub>a</sub> min.	S <sub>b</sub> min.	r <sub>a</sub> max.	r <sub>b</sub> max.		Y <sub>1</sub>	Y <sub>0</sub>		
35	80	22.75	21	18	2	1.5	69.8	77.8	5 200	7 000	30307XR	—	20.5	45	45	70	63	74	3	4.5	2	1.5	0.55	1.10	0.60	0.560
	80	22.75	21	18	2	1.5	76.2	78.9	5 200	6 900	30307JR-1	2FB	16.9	45	45	70	70	74	3	4.5	2	1.5	0.31	1.90	1.05	0.527
	80	32.75	31	25	2	1.5	96.9	123	5 200	7 000	TR0708-1R	—	23.8	45	44	70	60	75	3	7.5	2	1.5	0.47	1.27	0.70	0.830
	80	32.75	31	25	2	1.5	101	114	5 300	7 000	32307JR	2FE	20.6	45	44	70	66	74	3	7.5	2	1.5	0.31	1.90	1.05	0.776
40	62	15	15	12	0.6	0.6	33.5	48.5	5 900	7 800	32908JR	2BC	11.9	44.5	45	57.5	55	59	3	3	0.6	0.6	0.29	2.07	1.14	0.164
	68	19	19	14.5	1	1	53.5	71.4	5 600	7 400	32008JR	3CD	15.1	45.5	46	62.5	60	65	4	4.5	1	1	0.38	1.58	0.87	0.282
	68	22	22	18	1	1	60.4	84.6	5 500	7 400	33008JR	2BE	14.7	45.5	46	62.5	60	65	3	4	1	1	0.28	2.12	1.17	0.326
	75	26	26	20.5	1.5	1.5	82.2	108	5 200	6 900	33108JR	2CE	18.3	48.5	47	66.5	65	71	4	5.5	1.5	1.5	0.36	1.69	0.93	0.508
	80	19.75	18	15	1.5	1.5	61.4	67.4	5 000	6 700	30208CR	—	20.2	48.5	49	71.5	66	76	3	4.5	1.5	1.5	0.55	1.10	0.60	0.445
	80	19.75	18	16	1.5	1.5	62.9	69.2	5 000	6 700	30208JR	3DB	17.0	48.5	49	71.5	69	75	3	3.5	1.5	1.5	0.37	1.60	0.88	0.434
	80	24.75	23	19	1.5	1.5	78.5	93.1	5 000	6 700	32208CR	5DC	22.0	48.5	48	71.5	64	76	3	5.5	1.5	1.5	0.55	1.10	0.60	0.570
	80	24.75	23	19	1.5	1.5	77.7	90.8	5 000	6 600	32208JR	3DC	19.4	48.5	48	71.5	68	75	3	5.5	1.5	1.5	0.37	1.60	0.88	0.554
	80	32	32	25	1.5	1.5	108	139	5 000	6 700	33208JR	2DE	20.7	48.5	47	71.5	67	76	5	7	1.5	1.5	0.36	1.68	0.92	0.758
	85	33	32.5	28	2.5	2	114	143	4 800	6 400	T2EE040	2EE	21.9	52	48	75	70	80	5	5	2	2	0.34	1.74	0.96	0.900
	90	25.25	23	17	2	1.5	80.5	90.2	3 800	5 300	30308DJR	7FB	29.9	50	51	80	71	86.5	3	8	2	1.5	0.83	0.73	0.40	0.757
	90	25.25	23	20	2	1.5	87.3	98.5	4 600	6 100	30308XR	—	23.8	50	53	80	72	84	3	5	2	1.5	0.55	1.10	0.60	0.780
	90	25.25	23	20	2	1.5	90.6	101	4 500	6 100	30308JR	2FB	19.9	50	52	80	77	82	3	5	2	1.5	0.35	1.74	0.96	0.757
	90	35.25	33	26	2	1.5	112	138	4 700	6 200	TR0809AR	—	27.5	50	49	80	67	85	3	9	2	1.5	0.55	1.10	0.60	1.10
90	35.25	33	27	2	1.5	116	139	4 600	6 200	32308JR	2FD	24.3	50	50	80	73	82	3	8	2	1.5	0.35	1.74	0.96	1.06	
45	68	15	15	12	0.6	0.6	34.7	52.4	5 300	7 100	32909JR	2BC	12.5	49.5	50	63.5	61	64	3	3	0.6	0.6	0.32	1.88	1.04	0.190
	75	20	20	15.5	1	1	62.8	86.5	5 000	6 600	32009JR	3CC	16.5	50.5	51	69.5	67	72	4	4.5	1	1	0.39	1.53	0.84	0.354
	75	24	24	19	1	1	69.6	101	5 000	6 700	33009JR	2CE	16.4	50.5	51	69.5	67	71	4	5	1	1	0.29	2.04	1.12	0.416
	80	26	26	20.5	1.5	1.5	87.5	120	4 800	6 400	33109JR	3CE	19.4	53.5	52	71.5	69	76.5	4	5.5	1.5	1.5	0.38	1.57	0.86	0.563
	85	20.75	19	15	1.5	1.5	69.4	81.5	4 600	6 100	30209XR	—	21.1	53.5	54	76.5	71	80	4	5.5	1.5	1.5	0.55	1.10	0.60	0.500
	85	20.75	19	16	1.5	1.5	67.2	77.4	4 600	6 100	30209JR	3DB	18.9	53.5	54	76.5	74	80	3	4.5	1.5	1.5	0.40	1.48	0.81	0.502
	85	24.75	23	19	1.5	1.5	80.7	102	4 600	6 200	32209CR	—	23.0	53.5	53	76.5	69	81	3	5.5	1.5	1.5	0.55	1.10	0.60	0.625
	85	24.75	23	19	1.5	1.5	84.2	104	4 600	6 100	32209JR-1	3DC	20.3	53.5	53	76.5	73	81	3	5.5	1.5	1.5	0.40	1.48	0.81	0.597

[Note] 1) Please consult with JTEKT when using the bearings identified by suffix C. They are medium-tapered types especially designed for special purposes.

Single-row tapered roller bearings  
metric series

*d* (45) ~ (55) mm

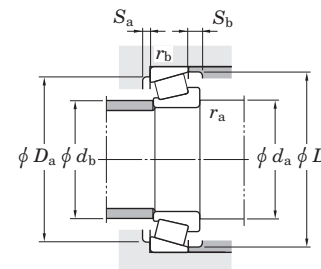
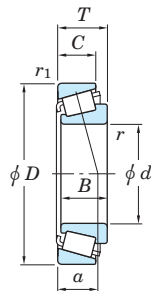

Boundary dimensions (mm)							Basic load ratings (kN)		Limiting speeds (min <sup>-1</sup> )		Bearing No. <sup>1)</sup>	Dimension series to ISO355 (Refer.)	Load center (mm) <i>a</i>	Mounting dimensions (mm)								Constant <i>e</i>	Axial load factors		(Refer.) Mass (kg)	
<i>d</i>	<i>D</i>	<i>T</i>	<i>B</i>	<i>C</i>	<i>r</i> min.	<i>r</i> <sub>1</sub> min.	<i>C</i> <sub>r</sub>	<i>C</i> <sub>0r</sub>	Grease lub.	Oil lub.				<i>d</i> <sub>a</sub> min.	<i>d</i> <sub>b</sub> max.	<i>D</i> <sub>a</sub> max.	<i>D</i> <sub>b</sub> min.	<i>S</i> <sub>a</sub> min.	<i>S</i> <sub>b</sub> min.	<i>r</i> <sub>a</sub> max.	<i>r</i> <sub>b</sub> max.		<i>Y</i> <sub>1</sub>	<i>Y</i> <sub>0</sub>		
45	85	32	32	25	1.5	1.5	112	149	4 600	6 200	<b>33209JR</b>	3DE	21.8	53.5	52	76.5	72	81	5	7	1.5	1.5	0.39	1.56	0.86	0.818
	95	29	26.5	20	2.5	2.5	94.1	118	3 600	5 100	<b>T7FC045</b>	7FC	32.6	57	54	83	71	91	3	9	2	2	0.87	0.69	0.38	0.943
	95	36	35	30	2.5	2.5	140	177	4 300	5 700	<b>T2ED045</b>	2ED	23.8	57	55	83	80	89	6	6	2	2	0.32	1.86	1.02	1.20
	100	27.25	25	18	2	1.5	95.1	107	3 400	4 700	<b>30309DJR</b>	7FB	32.9	55	56	90	79	96	3	9	2	1.5	0.83	0.73	0.40	0.973
	100	27.25	25	20	2	1.5	109	119	4 100	5 500	<b>30309CR</b>	—	25.7	55	57	90	81	94	4	7	2	1.5	0.55	1.10	0.60	1.00
	100	27.25	25	22	2	1.5	113	128	4 100	5 400	<b>30309JR</b>	2FB	21.3	55	59	90	86	93	3	5	2	1.5	0.35	1.74	0.96	1.01
	100	38.25	36	29	2	1.5	145	182	4 200	5 600	<b>32309CR</b>	—	30.3	55	56	90	76	95	4	9	2	1.5	0.55	1.10	0.60	1.45
100	38.25	36	30	2	1.5	146	180	4 100	5 500	<b>32309JR</b>	2FD	26.8	55	56	90	82	93	3	8	2	1.5	0.35	1.74	0.96	1.43	
50	72	15	15	12	0.6	0.6	35.9	56.3	4 900	6 600	<b>32910JR</b>	2BC	13.7	54.5	55	67.5	65	69	3	3	0.6	0.6	0.34	1.76	0.97	0.195
	80	20	20	15.5	1	1	65.7	94.5	4 600	6 100	<b>32010JR</b>	3CC	17.7	55.5	56	74.5	72	77	4	4.5	1	1	0.42	1.42	0.78	0.389
	80	24	24	19	1	1	73.0	110	4 600	6 100	<b>33010JR</b>	2CE	17.4	55.5	56	74.5	72	76	4	5	1	1	0.32	1.90	1.04	0.451
	85	26	26	20	1.5	1.5	89.4	127	4 400	5 900	<b>33110JR</b>	3CE	20.6	58.5	56	76.5	74	81.5	4	6	1.5	1.5	0.41	1.46	0.80	0.594
	90	21.75	20	16	1.5	1.5	77.2	95.8	4 300	5 700	<b>30210CR</b>	—	22.7	58.5	58	81.5	76	86	4	5.5	1.5	1.5	0.55	1.10	0.60	0.590
	90	21.75	20	17	1.5	1.5	76.5	91.7	4 300	5 700	<b>30210JR</b>	3DB	20.1	58.5	58	81.5	79	85	3	4.5	1.5	1.5	0.42	1.43	0.79	0.566
	90	24.75	23	19	1.5	1.5	84.5	113	4 300	5 700	<b>32210CR</b>	—	24.0	58.5	58	81.5	74	86	3	5.5	1.5	1.5	0.55	1.10	0.60	0.675
	90	24.75	23	19	1.5	1.5	85.0	105	4 300	5 700	<b>32210JR</b>	3DC	20.6	58.5	58	81.5	78	85	3	5.5	1.5	1.5	0.42	1.43	0.79	0.643
	90	32	32	24.5	1.5	1.5	119	167	4 300	5 700	<b>33210JR</b>	3DE	23.1	58.5	57	81.5	77	86.5	5	7.5	1.5	1.5	0.41	1.45	0.80	0.887
	100	36	35	30	2.5	2.5	157	196	4 100	5 400	<b>T2ED050</b>	2ED	24.5	62	58	88	84	94	6	6	2	2	0.34	1.75	0.96	1.28
	105	32	29	22	3	3	113	140	3 300	4 600	<b>T7FC050</b>	7FC	35.9	64	59	91	78	100	4	10	2.5	2.5	0.87	0.69	0.38	1.25
	110	29.25	27	19	2.5	2	115	133	3 100	4 300	<b>30310DJR</b>	7FB	35.0	62	62	98	87	105	3	10	2	2	0.83	0.73	0.40	1.25
	110	29.25	27	20	2.5	2	124	143	3 700	4 900	<b>30310CR</b>	—	27.5	62	64	98	90	103	4	9	2	2	0.55	1.10	0.60	1.25
	110	29.25	27	23	2.5	2	137	152	3 700	4 900	<b>30310JR</b>	2FB	22.9	62	65	98	95	102	3	6	2	2	0.35	1.74	0.96	1.32
	110	42.25	40	33	2.5	2	171	234	3 800	5 100	<b>32310CR</b>	5FD	33.4	62	61	98	81	103	4	9	2	2	0.55	1.10	0.60	2.00
	110	42.25	40	33	2.5	2	176	220	3 700	5 000	<b>32310JR</b>	2FD	29.4	62	62	98	90	102	3	9	2	2	0.35	1.74	0.96	1.89
55	80	17	17	14	1	1	44.6	73.3	4 400	5 900	<b>32911JR</b>	2BC	14.5	61	61	74	72	76	3	3	1	1	0.31	1.94	1.07	0.285
	90	23	23	17.5	1.5	1.5	84.6	121	4 100	5 500	<b>32011JR</b>	3CC	19.8	63.5	63	81.5	81	86	4	5.5	1.5	1.5	0.41	1.48	0.81	0.569
	90	27	27	21	1.5	1.5	96.5	149	4 100	5 400	<b>33011JR</b>	2CE	19.3	63.5	63	81.5	81	86	5	6	1.5	1.5	0.31	1.92	1.06	0.672

[Note] 1) Please consult with JTEKT when using the bearings identified by suffix C. They are medium-tapered types especially designed for special purposes.

Single-row tapered roller bearings  
metric series

d (55) ~ (60) mm

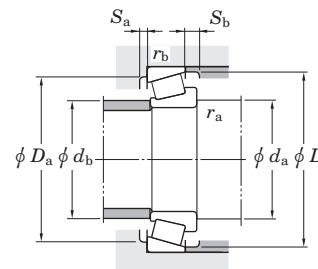
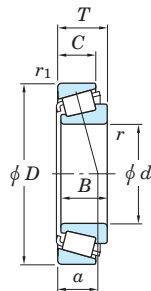

Boundary dimensions (mm)							Basic load ratings (kN)		Limiting speeds (min <sup>-1</sup> )		Bearing No. <sup>1)</sup>	Dimension series to ISO355 (Refer.)	Load center (mm) a	Mounting dimensions (mm)								Constant e	Axial load factors		(Refer.) Mass (kg)	
d	D	T	B	C	r min.	r1 min.	C <sub>r</sub>	C <sub>0r</sub>	Grease lub.	Oil lub.				d <sub>a</sub> min.	d <sub>b</sub> max.	D <sub>a</sub> max.	D <sub>b</sub> min.	S <sub>a</sub> min.	S <sub>b</sub> min.	r <sub>a</sub> max.	r <sub>b</sub> max.		Y <sub>1</sub>	Y <sub>0</sub>		
55	95	30	30	23	1.5	1.5	116	161	4 000	5 300	3311JR	3CE	22.5	63.5	62	86.5	83	91	5	7	1.5	1.5	0.37	1.60	0.88	0.868
	100	22.75	21	17	2	1.5	89.6	108	3 900	5 200	3021CR	—	24.3	65	63	90	84	95	4	5.5	2	1.5	0.55	1.10	0.60	0.750
	100	22.75	21	18	2	1.5	94.6	113	3 900	5 200	3021JR	3DB	20.7	65	64	90	88	94	4	4.5	2	1.5	0.40	1.48	0.81	0.732
	100	26.75	25	21	2	1.5	107	135	3 900	5 200	3221CR	—	25.9	65	64	90	83	96	4	5.5	2	1.5	0.55	1.10	0.60	0.875
	100	26.75	25	21	2	1.5	107	133	3 900	5 200	3221JR-1	3DC	23.0	65	63	90	87	95	4	5.5	2	1.5	0.40	1.48	0.81	0.863
	100	35	35	27	2	1.5	142	189	3 900	5 200	3321JR	3DE	25.3	65	62	90	85	96	6	8	2	1.5	0.40	1.50	0.83	1.18
	115	34	31	23.5	3	3	129	164	3 000	4 200	T7FC055	7FC	38.6	69	65	101	86	109	4	10.5	2.5	2.5	0.87	0.69	0.38	1.59
	120	31.5	29	21	2.5	2	129	148	2 900	4 000	3031DJR	7FB	38.4	67	68	108	94	113	4	10.5	2	2	0.83	0.73	0.40	1.59
	120	31.5	29	22	2.5	2	144	161	3 400	4 500	3031CR	—	29.8	67	70	108	97	112	4.5	9.5	2	2	0.55	1.10	0.60	1.58
	120	31.5	29	25	2.5	2	149	170	3 300	4 500	3031JR	2FB	25.5	67	71	108	104	111	4	6.5	2	2	0.35	1.74	0.96	1.65
	120	45.5	43	35	2.5	2	184	247	3 400	4 600	32311C	5FD	35.9	67	67	108	90	113	4	10	2	2	0.55	1.10	0.60	2.45
	120	45.5	43	35	2.5	2	171	203	3 400	4 500	32311J	2FD	32.4	67	68	108	99	111	4	10.5	2	2	0.35	1.74	0.96	2.24
	120	45.5	43	35	2.5	2	200	250	3 400	4 500	32311JR	2FD	32.4	67	68	108	99	111	4	10.5	2	2	0.35	1.74	0.96	2.38
	60	85	17	17	14	1	1	46.2	78.2	4 100	5 500	32912JR	2BC	15.6	65.5	66	79.5	77	81	3	3	1	1	0.33	1.81	1.00
95		23	23	17.5	1.5	1.5	86.1	127	3 900	5 200	32012JR	4CC	21.0	68.5	67	86.5	85	91	4	5.5	1.5	1.5	0.43	1.39	0.77	0.621
95		27	27	21	1.5	1.5	101	162	3 900	5 200	33012JR	2CE	20.1	68.5	67	86.5	85	90	5	6	1.5	1.5	0.33	1.83	1.01	0.719
100		30	30	23	1.5	1.5	118	170	3 700	5 000	33112JR	3CE	23.7	68.5	67	91.5	88	96	5	7	1.5	1.5	0.40	1.51	0.83	0.923
110		23.75	22	17	2	1.5	102	123	3 500	4 700	30212CR	—	26.2	70	70	100	93	104	4	6.5	2	1.5	0.55	1.10	0.60	0.930
110		23.75	22	19	2	1.5	106	127	3 500	4 700	30212JR	3EB	21.9	70	70	100	96	103	4	4.5	2	1.5	0.40	1.48	0.81	0.945
110		29.75	28	22	2	1.5	128	164	3 600	4 700	32212CR	—	28.6	70	68	100	91	105	4	7.5	2	1.5	0.55	1.10	0.60	1.20
110		29.75	28	24	2	1.5	132	167	3 500	4 700	32212JR	3EC	25.1	70	69	100	95	104	4	5.5	2	1.5	0.40	1.48	0.81	1.19
110		38	38	29	2	1.5	174	239	3 600	4 700	33212JR	3EE	27.2	70	69	100	93	105	6	9	2	1.5	0.40	1.48	0.82	1.57
115		39	38	31	4	2.5	158	227	3 400	4 600	T5ED060	5ED	32.4	78	70	103	92	110	5	8	3	2	0.53	1.13	0.62	1.81
115		40	39	33	2.5	2.5	183	242	3 400	4 600	T2EE060	2EE	27.6	72	70	103	98	109	6	7	2	2	0.33	1.80	0.99	1.80
125		37	33.5	26	3	3	153	194	2 800	3 900	T7FC060	7FC	40.8	74	71	111	94	119	4	11	2.5	2.5	0.82	0.73	0.40	2.03
130		33.5	31	22	3	2.5	153	179	2 600	3 700	30312DJR	7FB	40.8	74	73	118	103	124	4	11.5	2.5	2	0.83	0.73	0.40	2.01
130		33.5	31	23	3	2.5	169	196	3 100	4 200	30312CR	—	31.9	74	75	118	105	121	5	10.5	2.5	2	0.55	1.10	0.60	1.99

[Note] 1) Please consult with JTEKT when using the bearings identified by suffix C. They are medium-tapered types especially designed for special purposes.

Single-row tapered roller bearings  
metric series

d (60) ~ (70) mm

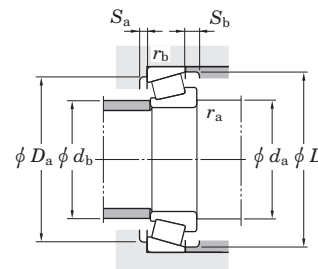
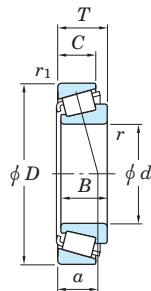

Boundary dimensions (mm)							Basic load ratings (kN)		Limiting speeds (min <sup>-1</sup> )		Bearing No. <sup>1)</sup>	Dimension series to ISO355 (Refer.)	Load center (mm) a	Mounting dimensions (mm)								Constant e	Axial load factors		(Refer.) Mass (kg)	
d	D	T	B	C	r min.	r1 min.	Cr	C0r	Grease lub.	Oil lub.				da min.	db max.	Da max.	Db min.	Sa min.	Sb min.	ra max.	rb max.		Y1	Y0		
<b>60</b>	130	33.5	31	26	3	2.5	173	201	3 100	4 100	<b>30312JR</b>	2FB	26.9	74	77	118	112	120	4	7.5	2.5	2	0.35	1.74	0.96	2.08
	130	48.5	46	37	3	2.5	229	310	3 200	4 300	<b>32312CR</b>	5FD	38.3	74	73	118	98	122	5	11	2.5	2	0.55	1.10	0.60	3.15
	130	48.5	46	37	3	2.5	221	275	3 100	4 200	<b>32312J</b>	2FD	32.3	74	74	118	107	120	4	11.5	2.5	2	0.35	1.74	0.96	2.87
	130	48.5	46	37	3	2.5	244	315	3 100	4 200	<b>32312JR</b>	2FD	32.3	74	74	118	107	120	4	11.5	2.5	2	0.35	1.74	0.96	2.99
<b>65</b>	90	17	17	14	1	1	47.4	83.1	3 900	5 200	<b>32913JR</b>	2BC	16.8	70.5	70	84.5	81	86	3	3	1	1	0.35	1.70	0.93	0.327
	100	23	23	17.5	1.5	1.5	90.0	137	3 600	4 800	<b>32013JR</b>	4CC	22.5	73.5	72	91.5	90	97	4	5.5	1.5	1.5	0.46	1.31	0.72	0.664
	100	27	27	21	1.5	1.5	103	169	3 600	4 800	<b>33013JR</b>	2CE	21.1	73.5	72	91.5	89	96	5	6	1.5	1.5	0.35	1.72	0.95	0.762
	110	34	34	26.5	1.5	1.5	152	223	3 400	4 600	<b>33113JR</b>	3DE	25.9	73.5	73	101.5	96	106	6	7.5	1.5	1.5	0.39	1.55	0.85	1.33
	120	24.75	23	18	2	1.5	116	139	3 200	4 300	<b>30213CR</b>	—	28.1	75	77	110	102	114	4	6.5	2	1.5	0.55	1.10	0.60	1.15
	120	24.75	23	20	2	1.5	128	156	3 200	4 300	<b>30213JR</b>	3EB	24.2	75	77	110	106	113	4	4.5	2	1.5	0.40	1.48	0.81	1.18
	120	32.75	31	24	2	1.5	151	198	3 200	4 300	<b>32213CR</b>	—	31.3	75	75	110	99	114	4	8.5	2	1.5	0.55	1.10	0.60	1.55
	120	32.75	31	27	2	1.5	157	203	3 200	4 300	<b>32213JR</b>	3EC	26.6	75	76	110	104	115	4	5.5	2	1.5	0.40	1.48	0.81	1.58
	120	39	38	31	4	2.5	151	232	3 200	4 300	<b>T5ED065</b>	5ED	34.1	83	75	108	96	115	5	8	3	2	0.56	1.07	0.59	1.93
	120	41	41	32	2	1.5	200	277	3 200	4 300	<b>33213JR</b>	3EE	30.0	75	74	110	102	115	7	9	2	1.5	0.39	1.54	0.85	2.02
	130	37	33.5	26	3	3	148	211	2 600	3 600	<b>T7FC065</b>	7FC	44.4	79	78	116	98	124	4	11	2.5	2.5	0.87	0.69	0.38	2.17
	140	36	33	23	3	2.5	176	209	2 400	3 400	<b>30313DJR</b>	7GB	44.3	79	79	128	111	133	4	13	2.5	2	0.83	0.73	0.40	2.44
	140	36	33	25	3	2.5	193	227	2 900	3 900	<b>30313CR</b>	—	34.3	79	81	128	113	130	5	11	2.5	2	0.55	1.10	0.60	2.44
	140	36	33	28	3	2.5	204	239	2 800	3 800	<b>30313JR</b>	2GB	29.3	79	83	128	122	130	4	8	2.5	2	0.35	1.74	0.96	2.56
	140	51	48	39	3	2.5	258	361	2 900	3 900	<b>32313CR</b>	5GD	40.9	79	79	128	106	131	5	12	2.5	2	0.55	1.10	0.60	3.85
	140	51	48	39	3	2.5	250	312	2 900	3 900	<b>32313J</b>	2GD	34.7	79	80	128	117	130	4	12	2.5	2	0.35	1.74	0.96	3.49
140	51	48	39	3	2.5	276	357	2 900	3 900	<b>32313JR</b>	2GD	34.7	79	80	128	117	130	4	12	2.5	2	0.35	1.74	0.96	3.64	
<b>70</b>	100	20	20	16	1	1	71.0	115	3 500	4 700	<b>32914JR</b>	2BC	17.8	75.5	77	94.5	91	96	4	4	1	1	0.32	1.90	1.05	0.496
	110	25	25	19	1.5	1.5	108	163	3 300	4 400	<b>32014JR</b>	4CC	23.6	78.5	78	101.5	98	105	5	6	1.5	1.5	0.43	1.38	0.76	0.884
	110	31	31	25.5	1.5	1.5	134	208	3 300	4 400	<b>33014JR</b>	2CE	22.1	78.5	78	101.5	99	105	5	5.5	1.5	1.5	0.28	2.11	1.16	1.09
	120	37	37	29	2	1.5	181	266	3 100	4 200	<b>33114JR</b>	3DE	28.0	80	79	110	104	115	6	8	2	1.5	0.38	1.58	0.87	1.71
	125	26.25	24	19	2	1.5	126	158	3 000	4 000	<b>30214CR</b>	—	29.9	80	82	116.5	107	119	4	7	2	1.5	0.55	1.10	0.60	1.30
	125	26.25	24	21	2	1.5	138	173	3 100	4 100	<b>30214JR</b>	3EB	25.9	80	81	116.5	110	118	4	5	2	1.5	0.42	1.43	0.79	1.32

[Note] 1) Please consult with JTEKT when using the bearings identified by suffix C. They are medium-tapered types especially designed for special purposes.



Single-row tapered roller bearings  
metric series

$d$  (70) ~ (75) mm

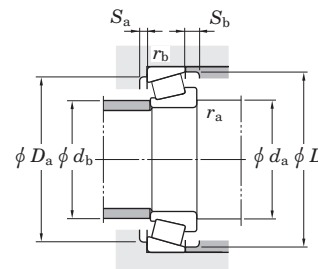
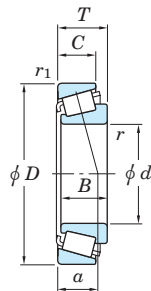

Boundary dimensions (mm)							Basic load ratings (kN)		Limiting speeds (min <sup>-1</sup> )		Bearing No. <sup>1)</sup>	Dimension series to ISO355 (Refer.)	Load center (mm) a	Mounting dimensions (mm)								Constant e	Axial load factors		(Refer.) Mass (kg)		
d	D	T	B	C	r min.	r1 min.	C <sub>r</sub>	C <sub>0r</sub>	Grease lub.	Oil lub.				d <sub>a</sub> min.	d <sub>b</sub> max.	D <sub>a</sub> max.	D <sub>b</sub> min.	S <sub>a</sub> min.	S <sub>b</sub> min.	r <sub>a</sub> max.	r <sub>b</sub> max.		Y <sub>1</sub>	Y <sub>0</sub>			
70	125	33.25	31	24	2	1.5	157	212	3 100	4 100	<b>32214CR</b>	—	32.6	80	80	116.5	104	120	4	9.5	2	1.5	0.55	1.10	0.60	1.65	
	125	33.25	31	27	2	1.5	169	225	3 100	4 100	<b>32214JR</b>	3EC	29.2	80	80	116.5	108	119	4	6	2	1.5	0.42	1.43	0.79	1.71	
	125	41	41	32	2	1.5	206	294	3 100	4 100	<b>33214JR</b>	3EE	31.2	80	79	116.5	107	120	7	9	2	1.5	0.41	1.47	0.81	2.16	
	130	43	42	35	3	2.5	233	319	3 000	4 000	<b>T2ED070</b>	2ED	30.2	84	81	118	111	123	1	1	2.5	2	0.33	1.80	0.99	2.48	
	140	39	35.5	27	3	3	177	242	2 400	3 400	<b>T7FC070</b>	7FC	46.5	84	82	126	106	133	5	12	2.5	2.5	0.87	0.69	0.38	2.64	
	140	52	51	43	5	3	264	382	2 900	3 800	<b>T4FE070</b>	4FE	37.7	92	82	126	111	133	7	9	4	2.5	0.45	1.34	0.74	3.69	
	150	38	35	25	3	2.5	197	235	2 300	3 200	<b>30314DJR</b>	7GB	47.1	84	84	138	118	142	4	13	2.5	2	0.83	0.73	0.40	2.97	
	150	38	35	30	3	2.5	224	256	2 700	3 600	<b>30314CR</b>	—	37.0	84	87	138	123	141	6	8	2.5	2	0.55	1.10	0.60	3.10	
	150	38	35	30	3	2.5	230	273	2 600	3 500	<b>30314JR</b>	2GB	30.5	84	89	138	130	140	4	8	2.5	2	0.35	1.74	0.96	3.08	
	150	54	51	42	3	2.5	257	315	2 700	3 600	<b>32314</b>	—	37.0	84	86	138	125	140	4	12	2.5	2	0.35	1.73	0.95	4.11	
	150	54	51	42	3	2.5	297	391	2 700	3 600	<b>32314C</b>	5GD	44.4	84	84	138	115	142	5	12	2.5	2	0.55	1.10	0.60	4.50	
	150	54	51	42	3	2.5	317	414	2 700	3 600	<b>32314JR</b>	2GD	37.4	84	86	138	125	140	4	12	2.5	2	0.35	1.74	0.96	4.50	
	75	105	20	20	16	1	1	73.6	123	3 300	4 400	<b>32915JR</b>	2BC	18.9	80.5	81	99.5	96	101	4	4	1	1	0.33	1.80	0.99	0.526
		115	25	25	19	1.5	1.5	110	169	3 100	4 200	<b>32015JR</b>	4CC	25.1	83.5	83	106.5	103	110	5	6	1.5	1.5	0.46	1.31	0.72	0.930
115		31	31	25.5	1.5	1.5	141	225	3 200	4 200	<b>33015JR</b>	2CE	22.9	83.5	83	106.5	104	110	6	5.5	1.5	1.5	0.30	2.01	1.11	1.16	
125		37	37	29	2	1.5	186	280	3 000	4 000	<b>33115JR</b>	3DE	29.3	85	84	116.5	109	120	6	8	2	1.5	0.40	1.51	0.83	1.84	
130		27.25	25	20	2	1.5	136	178	2 900	3 800	<b>30215CR</b>	—	31.0	85	87	121.5	111	124	5	7	2	1.5	0.55	1.10	0.60	1.40	
130		27.25	25	22	2	1.5	142	181	2 900	3 900	<b>30215JR</b>	4DB	27.6	85	86	121.5	115	124	4	5	2	1.5	0.44	1.38	0.76	1.42	
130		33.25	31	24	2	1.5	163	225	2 900	3 900	<b>32215CR</b>	—	33.7	85	85	121.5	109	125	4	9	2	1.5	0.55	1.10	0.60	1.75	
130		33.25	31	27	2	1.5	174	234	2 900	3 900	<b>32215JR</b>	4DC	30.2	85	85	121.5	114	125	4	6	2	1.5	0.44	1.38	0.76	1.77	
130		41	41	31	2	1.5	212	310	2 900	3 900	<b>33215JR</b>	3EE	32.5	85	83	121.5	111	125	7	10	2	1.5	0.43	1.40	0.77	2.26	
150		42	38	29	3	3	191	270	2 200	3 100	<b>T7FC075</b>	7FC	50.6	89	89	136	114	143	5	13	2.5	2.5	0.87	0.69	0.38	3.24	
160		40	37	26	3	2.5	213	254	2 100	2 900	<b>30315DJR</b>	7GB	49.9	89	91	148	127	151	6	14	2.5	2	0.83	0.73	0.40	3.45	
160		40	37	26	3	2.5	222	266	2 100	2 900	<b>30315DR</b>	—	48.8	89	91	148	127	151	6	14	2.5	2	0.81	0.74	0.41	3.48	
160		40	37	31	3	2.5	248	296	2 500	3 400	<b>30315CR</b>	—	39.2	89	94	148	130	150	6	9	2.5	2	0.55	1.10	0.60	3.80	
160		40	37	31	3	2.5	260	311	2 500	3 300	<b>30315JR</b>	2GB	32.5	89	95	148	139	149	4	9	2.5	2	0.35	1.74	0.96	3.65	
160		40	37	31	3	2.5	251	298	2 500	3 300	<b>30315R</b>	—	31.9	89	95	148	139	149	4	9	2.5	2	0.35	1.73	0.95	3.52	

[Note] 1) Please consult with JTEKT when using the bearings identified by suffix C. They are medium-tapered types especially designed for special purposes.

Single-row tapered roller bearings  
metric series

d (75) ~ (85) mm

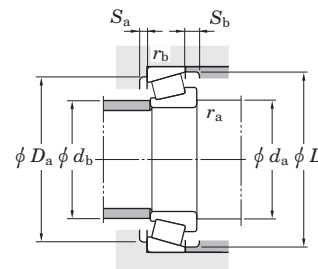
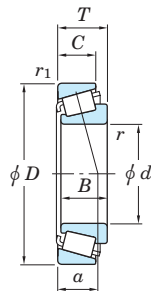

Boundary dimensions (mm)							Basic load ratings (kN)		Limiting speeds (min <sup>-1</sup> )		Bearing No. <sup>1)</sup>	Dimension series to ISO355 (Refer.)	Load center (mm) a	Mounting dimensions (mm)								Constant e	Axial load factors		(Refer.) Mass (kg)	
d	D	T	B	C	r min.	r1 min.	Cr	C0r	Grease lub.	Oil lub.				da min.	db max.	Da max.	Db min.	Sa min.	Sb min.	ra max.	rb max.		Y1	Y0		
75	160	58	55	43	3	2.5	357	474	2 500	3 400	32315CR	—	46.6	89	90	148	125	154	6	15	2.5	2	0.55	1.10	0.60	5.50
	160	58	55	45	3	2.5	363	481	2 500	3 300	32315JR	2GD	40.0	89	91	148	133	149	4	13	2.5	2	0.35	1.74	0.96	5.41
	160	58	55	45	3	2.5	340	444	2 500	3 300	32315R	—	39.5	89	91	148	133	149	4	13	2.5	2	0.35	1.73	0.95	5.30
80	110	20	20	16	1	1	76.1	131	3 100	4 200	32916JR	2BC	20.1	85.5	86	104.5	101	106	4	4	1	1	0.35	1.71	0.94	0.556
	125	29	29	22	1.5	1.5	147	225	2 900	3 900	32016JR	3CC	26.7	88.5	89	116.5	112	120	6	7	1.5	1.5	0.42	1.42	0.78	1.32
	125	36	36	29.5	1.5	1.5	173	288	2 900	3 900	33016JR	2CE	25.1	88.5	90	116.5	112	119	6	6.5	1.5	1.5	0.28	2.16	1.19	1.63
	130	37	37	29	2	1.5	191	294	2 800	3 800	33116JR	3DE	30.5	90	89	121.5	114	126	6	8	2	1.5	0.42	1.44	0.79	1.93
	140	28.25	26	22	2.5	2	161	202	2 700	3 600	30216JR	3EB	28.6	92	91	130	124	132	4	6	2	2	0.42	1.43	0.79	1.72
	140	35.25	33	28	2.5	2	203	271	2 700	3 600	32216JR	3EC	31.7	92	90	130	122	134	4	7	2	2	0.42	1.43	0.79	2.17
	140	46	46	35	2.5	2	250	371	2 700	3 600	33216JR	3EE	35.7	92	89	130	119	135	7	11	2	2	0.43	1.41	0.78	2.99
	145	46	45	38	3	2.5	266	381	2 600	3 500	T2ED080	2ED	32.7	94	92	133	125	137	7	8	2.5	2	0.32	1.88	1.03	3.20
	170	42.5	39	27	3	2.5	236	282	2 000	2 800	30316DJR	7GB	53.5	94	97	158	134	159	6	15.5	2.5	2	0.83	0.73	0.40	4.12
	170	42.5	39	33	3	2.5	294	355	2 300	3 100	30316JR	2GB	34.8	94	102	158	148	159	4	9.5	2.5	2	0.35	1.74	0.96	4.46
	170	42.5	39	33	3	2.5	277	330	2 300	3 100	30316R	—	33.9	94	102	158	148	159	4	9.5	2.5	2	0.35	1.73	0.95	4.26
	170	61.5	58	48	3	2.5	347	440	2 300	3 100	32316J	2GD	43.5	94	98	158	142	159	4	13.5	2.5	2	0.35	1.74	0.96	6.04
	170	61.5	58	48	3	2.5	383	503	2 300	3 100	32316JR	2GD	43.5	94	98	158	142	159	4	13.5	2.5	2	0.35	1.74	0.96	6.31
85	120	23	23	18	1.5	1.5	97.1	165	2 900	3 900	32917JR	2BC	21.2	93.5	93	111.5	109	115	5	5	1.5	1.5	0.33	1.83	1.01	0.794
	130	29	29	22	1.5	1.5	150	234	2 800	3 700	32017JR	4CC	28.0	93.5	94	121.5	117	125	6	7	1.5	1.5	0.44	1.36	0.75	1.38
	130	36	36	29.5	1.5	1.5	177	300	2 800	3 700	33017JR	2CE	26.3	93.5	94	121.5	118	125	6	6.5	1.5	1.5	0.29	2.06	1.13	1.72
	140	41	41	32	2.5	2	224	346	2 600	3 500	33117JR	3DE	33.2	97	95	130	122	135	7	9	2	2	0.41	1.48	0.81	2.43
	150	30.5	28	24	2.5	2	182	231	2 500	3 400	30217JR	3EB	30.4	97	97	140	132	141	5	6.5	2	2	0.42	1.43	0.79	2.17
	150	38.5	36	30	2.5	2	232	315	2 500	3 400	32217JR	3EC	34.2	97	96	140	130	142	5	8.5	2	2	0.42	1.43	0.79	2.80
	150	49	49	37	2.5	2	294	439	2 500	3 400	33217JR	3EE	37.1	97	95	140	128	144	7	12	2	2	0.42	1.43	0.79	3.63
	180	44.5	41	28	4	3	231	265	1 900	2 600	30317D	—	56.0	103	103	166	143	169	6	16.5	3	2.5	0.81	0.74	0.41	4.54
	180	44.5	41	28	4	3	263	317	1 900	2 600	30317DJR	7GB	56.3	103	103	166	143	169	6	16.5	3	2.5	0.83	0.73	0.40	4.81
	180	44.5	41	34	4	3	316	384	2 200	2 900	30317JR	2GB	36.0	103	107	166	156	167	5	10.5	3	2.5	0.35	1.74	0.96	5.15
	180	44.5	41	34	4	3	305	367	2 200	2 900	30317R	—	35.8	103	107	166	156	167	5	10.5	3	2.5	0.35	1.73	0.95	4.97

[Note] 1) Please consult with JTEKT when using the bearings identified by suffix C. They are medium-tapered types especially designed for special purposes.

Single-row tapered roller bearings  
metric series

d (85) ~ 95 mm

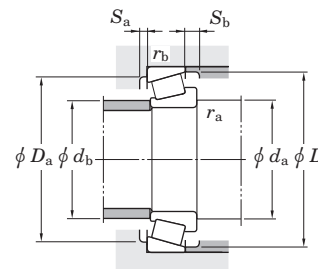
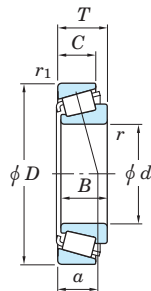

Boundary dimensions (mm)							Basic load ratings (kN)		Limiting speeds (min <sup>-1</sup> )		Bearing No.	Dimension series to ISO355 (Refer.)	Load center (mm) a	Mounting dimensions (mm)								Constant e	Axial load factors		(Refer.) Mass (kg)	
d	D	T	B	C	r min.	r1 min.	Cr	C0r	Grease lub.	Oil lub.				da min.	db max.	Da max.	Db min.	Sa min.	Sb min.	ra max.	rb max.		Y1	Y0		
<b>85</b>	180	63.5	60	49	4	3	439	587	2 200	3 000	<b>32317JR</b>	2GD	43.8	103	103	166	150	167	5	14.5	3	2.5	0.35	1.74	0.96	7.42
<b>90</b>	125	23	23	18	1.5	1.5	101	175	2 800	3 700	<b>32918JR</b>	2BC	22.3	98.5	97	116.5	114	120	5	5	1.5	1.5	0.34	1.75	0.96	0.834
	140	32	32	24	2	1.5	178	276	2 600	3 500	<b>32018JR</b>	3CC	29.8	100	100	131.5	125	134	6	8	2	1.5	0.42	1.42	0.78	1.80
	140	39	39	32.5	2	1.5	221	367	2 600	3 400	<b>33018JR</b>	2CE	27.1	100	100	131.5	127	135	7	6.5	2	1.5	0.27	2.23	1.23	2.22
	150	45	45	35	2.5	2	258	413	2 500	3 300	<b>33118JR</b>	3DE	35.4	102	100	140	130	144	7	10	2	2	0.40	1.51	0.83	3.13
	155	46	46	38	3	3	273	405	2 400	3 200	<b>T2ED090</b>	2ED	33.5	104	102	141	135	147	7	8	2.5	2.5	0.33	1.84	1.01	3.47
	160	32.5	30	26	2.5	2	204	261	2 400	3 200	<b>30218JR</b>	3FB	32.6	102	103	150	140	150	5	6.5	2	2	0.42	1.43	0.79	2.65
	160	42.5	40	34	2.5	2	263	362	2 400	3 200	<b>32218JR</b>	3FC	37.0	102	102	150	138	152	5	8.5	2	2	0.42	1.43	0.79	3.47
	160	55	55	42	2.5	2	343	527	2 400	3 200	<b>33218JR</b>	3FE	40.8	102	101	150	135	154	9	13	2	2	0.42	1.43	0.78	4.76
	190	46.5	43	30	4	3	288	350	1 700	2 400	<b>30318DJR</b>	7GB	59.6	108	109	176	151	179	6	16.5	3	2.5	0.83	0.73	0.40	5.57
	190	46.5	43	30	4	3	282	336	1 700	2 400	<b>30318DR</b>	—	59.1	108	109	176	151	179	6	16.5	3	2.5	0.81	0.74	0.41	5.60
	190	46.5	43	36	4	3	345	420	2 100	2 700	<b>30318JR</b>	2GB	38.1	108	113	176	165	177	5	10.5	3	2.5	0.35	1.74	0.96	6.04
	190	46.5	43	36	4	3	336	407	2 100	2 700	<b>30318R</b>	—	37.2	108	113	176	165	177	5	10.5	3	2.5	0.35	1.73	0.95	5.78
190	67.5	64	53	4	3	461	614	2 100	2 800	<b>32318JR</b>	2GD	46.6	108	108	176	157	177	5	14.5	3	2.5	0.35	1.74	0.96	8.61	
<b>95</b>	130	23	23	18	1.5	1.5	104	186	2 600	3 500	<b>32919JR</b>	2BC	23.5	103.5	102	121.5	119	125	5	5	1.5	1.5	0.36	1.68	0.92	0.876
	145	32	32	24	2	1.5	182	287	2 500	3 300	<b>32019JR</b>	4CC	31.2	105	105	136.5	130	140	6	8	2	1.5	0.44	1.36	0.75	1.88
	145	39	39	32.5	2	1.5	226	382	2 500	3 300	<b>33019JR</b>	2CE	27.8	105	104	136.5	131	139	7	6.5	2	1.5	0.28	2.16	1.19	2.31
	160	46	46	38	3	3	281	427	2 300	3 100	<b>T2ED095</b>	2ED	34.6	109	107	146	140	152	7	8	2.5	2.5	0.34	1.77	0.97	3.62
	160	49	49	38	2.5	2	304	473	2 300	3 100	<b>33119JR</b>	3EE	37.3	107	106	150	138	154	8	11	2	2	0.39	1.54	0.85	3.89
	170	34.5	32	27	3	2.5	231	299	2 200	3 000	<b>30219JR</b>	3FB	34.9	109	110	158	149	159	5	7.5	2.5	2	0.42	1.43	0.79	3.20
	170	45.5	43	37	3	2.5	311	439	2 200	3 000	<b>32219JR</b>	3FC	38.9	109	108	158	145	161	5	8.5	2.5	2	0.42	1.43	0.79	4.34
	170	58	58	44	3	2.5	374	582	2 200	2 900	<b>33219JR</b>	3FE	42.8	109	107	158	144	163	9	14	2.5	2	0.41	1.47	0.81	5.66
	200	49.5	45	32	4	3	319	391	1 700	2 300	<b>30319DJR</b>	7GB	62.7	113	113	186	157	187	6	17.5	3	2.5	0.83	0.73	0.40	6.68
	200	49.5	45	38	4	3	317	368	2 000	2 600	<b>30319</b>	—	39.8	113	118	186	172	186	5	11.5	3	2.5	0.35	1.73	0.95	6.32
	200	49.5	45	38	4	3	372	455	2 000	2 600	<b>30319JR</b>	2GB	40.8	113	118	186	172	186	5	11.5	3	2.5	0.35	1.74	0.96	6.96
	200	71.5	67	55	4	3	427	544	2 000	2 600	<b>32319</b>	—	49.1	113	115	186	166	186	5	16.5	3	2.5	0.35	1.73	0.95	9.35
200	71.5	67	55	4	3	517	695	2 000	2 600	<b>32319JR</b>	2GD	49.8	113	115	186	166	186	5	16.5	3	2.5	0.35	1.74	0.96	10.1	

Single-row tapered roller bearings  
metric series

$d$  100 ~ (105) mm

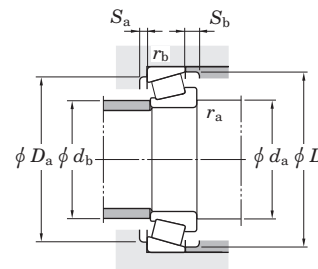
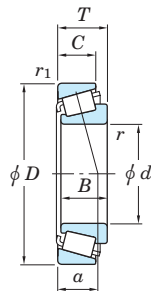

Boundary dimensions (mm)							Basic load ratings (kN)		Limiting speeds (min <sup>-1</sup> )		Bearing No.	Dimension series to ISO355 (Refer.)	Load center (mm) a	Mounting dimensions (mm)								Constant e	Axial load factors		(Refer.) Mass (kg)	
d	D	T	B	C	r min.	r1 min.	Cr	C0r	Grease lub.	Oil lub.				da min.	db max.	Da max.	Db min.	Sa min.	Sb min.	ra max.	rb max.		Y1	Y0		
100	140	25	25	20	1.5	1.5	126	217	2 400	3 300	32920JR	2CC	24.0	109	108	131	128	135	5	5	1.5	1.5	0.33	1.82	1.00	1.19
	145	24	22.5	17.5	3	3	116	167	2 400	3 200	T4CB100	4CB	29.9	112	109	133	132	140	4	6.5	2.5	2.5	0.47	1.27	0.70	1.12
	150	32	32	24	2	1.5	185	298	2 400	3 200	32020JR	4CC	32.6	110	109	141	134	144	6	8	2	1.5	0.46	1.31	0.72	1.95
	150	39	39	32.5	2	1.5	231	397	2 400	3 200	33020JR	2CE	28.6	110	108	141	135	143	7	6.5	2	1.5	0.29	2.09	1.15	2.40
	165	47	46	39	3	3	293	458	2 200	3 000	T2EE100	2EE	35.1	114	112	151	145	157	7	8	2.5	2.5	0.32	1.88	1.04	3.86
	165	52	52	40	2.5	2	325	523	2 200	3 000	33120JR	3EE	40.1	112	111	155	142	159	8	12	2	2	0.41	1.48	0.81	4.29
	180	37	34	29	3	2.5	258	338	2 100	2 800	30220JR	3FB	36.8	114	116	168	157	168	5	8	2.5	2	0.42	1.43	0.79	3.83
	180	49	46	39	3	2.5	347	495	2 100	2 800	32220JR	3FC	42.1	114	114	168	154	171	5	10	2.5	2	0.42	1.43	0.79	5.21
	180	63	63	48	3	2.5	431	680	2 100	2 800	32320JR	3FE	45.7	114	112	168	151	172	10	15	2.5	2	0.40	1.48	0.82	6.92
	215	51.5	47	34	4	3	318	374	1 500	2 100	30320D	—	65.9	118	121	201	183	204	5	17	3	2.5	0.81	0.74	0.41	8.02
	215	51.5	47	39	4	3	344	400	1 800	2 400	30320	—	41.4	118	127	201	184	200	6	12.5	3	2.5	0.35	1.73	0.95	7.76
	215	51.5	47	39	4	3	422	521	1 800	2 400	30320JR	2GB	42.7	118	127	201	184	200	6	12.5	3	2.5	0.35	1.74	0.96	8.49
	215	56.5	51	35	4	3	373	459	1 500	2 200	31320JR	7GB	67.7	118	120	201	183	202	6	17.5	3	2.5	0.83	0.73	0.40	8.72
	215	77.5	73	60	4	3	491	637	1 800	2 400	32320	—	52.6	118	123	201	177	200	8	17.5	3	2.5	0.35	1.73	0.95	12.2
215	77.5	73	60	4	3	579	783	1 800	2 400	32320JR	2GD	53.9	118	123	201	177	200	8	17.5	3	2.5	0.35	1.74	0.96	13.0	
105	145	25	25	20	1.5	1.5	128	224	2 400	3 100	32921JR	2CC	25.1	113.5	113	136.5	133	140	5	5	1.5	1.5	0.34	1.75	0.96	1.23
	160	35	35	26	2.5	2	215	344	2 200	3 000	32021JR	4DC	34.5	117	116	150	143	154	6	9	2	2	0.44	1.35	0.74	2.45
	160	43	43	34	2.5	2	267	461	2 200	3 000	33021JR	2DE	30.9	117	116	150	145	153	7	9	2	2	0.28	2.12	1.17	3.08
	175	56	56	44	2.5	2	360	607	2 100	2 800	33121JR	3EE	43.2	117	116	165	150	169	9	12	2	2	0.40	1.48	0.82	5.33
	190	39	36	30	3	2.5	288	380	2 000	2 600	30221JR	3FB	39.0	119	122	178	165	178	6	9	2.5	2	0.42	1.43	0.79	4.49
	190	53	50	43	3	2.5	392	567	2 000	2 700	32221JR	3FC	44.8	119	120	178	161	180	6	10	2.5	2	0.42	1.43	0.79	6.37
	190	68	68	52	3	2.5	497	790	2 000	2 600	33221JR	3FE	48.8	119	117	178	159	182	10	16	2.5	2	0.40	1.49	0.82	8.43
	225	53.5	49	36	4	3	339	396	1 400	2 000	30321D	—	69.1	123	127	211	193	209	6	17	3	2.5	0.81	0.74	0.41	8.76
	225	53.5	49	41	4	3	371	432	1 700	2 300	30321	—	43.1	123	132	211	193	209	7	12.5	3	2.5	0.35	1.73	0.95	8.74
	225	53.5	49	41	4	3	464	578	1 700	2 300	30321JR	2GB	44.1	123	132	211	193	209	7	12.5	3	2.5	0.35	1.74	0.96	9.73
	225	58	53	36	4	3	397	489	1 500	2 100	31321JR	7GB	70.3	123	126	211	193	211	6	18	3	2.5	0.83	0.73	0.40	9.72
	225	81.5	77	63	4	3	543	707	1 800	2 300	32321	—	55.7	123	128	211	185	209	8	18.5	3	2.5	0.35	1.73	0.95	13.9

Single-row tapered roller bearings  
metric series

$d$  (105) ~ 120 mm

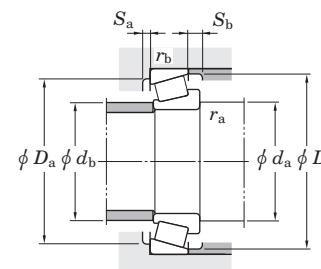
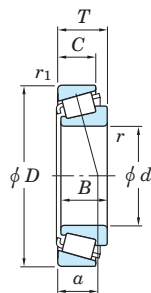

Boundary dimensions (mm)							Basic load ratings (kN)		Limiting speeds (min <sup>-1</sup> )		Bearing No.	Dimension series to ISO355 (Refer.)	Load center (mm) a	Mounting dimensions (mm)								Constant e	Axial load factors		(Refer.) Mass (kg)	
d	D	T	B	C	r min.	r1 min.	Cr	C0r	Grease lub.	Oil lub.				da min.	db max.	Da max.	Db min.	Sa min.	Sb min.	ra max.	rb max.		Y1	Y0		
<b>105</b>	225	81.5	77	63	4	3	635	866	1 800	2 300	<b>32321JR</b>	2GD	56.1	123	128	211	185	209	8	18.5	3	2.5	0.35	1.74	0.96	14.9
<b>110</b>	150	25	25	20	1.5	1.5	129	231	2 300	3 000	<b>32922JR</b>	2CC	26.3	119	118	141	138	145	5	5	1.5	1.5	0.36	1.69	0.93	1.28
	160	27	25.5	19.5	3	3	146	225	2 200	2 900	<b>T4CB110</b>	4CB	31.8	124	120	146	145	154	5	7.5	2.5	2.5	0.44	1.36	0.75	1.63
	170	38	38	29	2.5	2	248	395	2 100	2 800	<b>32022JR</b>	4DC	36.1	122	122	160	152	163	7	9	2	2	0.43	1.39	0.77	3.12
	170	47	47	37	2.5	2	287	502	2 100	2 800	<b>33022JR</b>	2DE	33.4	122	123	160	152	161	7	10	2	2	0.29	2.09	1.15	3.81
	180	56	56	43	2.5	2	369	634	2 000	2 700	<b>33122JR</b>	3EE	44.5	122	121	170	155	174	9	13	2	2	0.42	1.43	0.79	5.52
	200	41	38	32	3	2.5	324	434	1 900	2 500	<b>30222JR</b>	3FB	40.8	124	129	188	174	188	6	9	2.5	2	0.42	1.43	0.79	5.33
	200	56	53	46	3	2.5	438	640	1 900	2 500	<b>32222JR</b>	3FC	46.7	124	126	188	170	190	6	10	2.5	2	0.42	1.43	0.79	7.45
	240	54.5	50	36	4	3	365	429	1 400	1 900	<b>30322D</b>	—	71.5	128	135	226	205	222	6	18	3	2.5	0.81	0.74	0.41	10.2
	240	54.5	50	42	4	3	407	475	1 600	2 100	<b>30322</b>	—	44.8	128	141	226	206	222	8	12.5	3	2.5	0.35	1.73	0.95	10.4
	240	54.5	50	42	4	3	481	590	1 600	2 100	<b>30322JR</b>	2GB	46.3	128	141	226	206	222	8	12.5	3	2.5	0.35	1.74	0.96	11.4
	240	63	57	38	4	3	452	563	1 400	1 900	<b>31322JR</b>	7GB	76.2	128	135	226	205	224	6	21	3	2.5	0.83	0.73	0.40	12.2
	240	84.5	80	65	4	3	607	797	1 600	2 200	<b>32322</b>	—	57.3	128	137	226	198	222	9	19.5	3	2.5	0.35	1.73	0.95	16.6
	240	84.5	80	65	4	3	691	943	1 600	2 200	<b>32322JR</b>	2GD	59.3	128	137	226	198	222	9	19.5	3	2.5	0.35	1.74	0.96	17.8
<b>120</b>	165	29	29	23	1.5	1.5	172	298	2 100	2 700	<b>32924JR</b>	2CC	29.4	129	128	156	152	160	6	6	1.5	1.5	0.35	1.72	0.95	1.77
	170	27	25	19.5	3	3	164	262	2 000	2 700	<b>T4CB120</b>	4CB	34.6	134	130	156	155	164	4	7.5	2.5	2.5	0.47	1.27	0.70	1.76
	180	38	38	29	2.5	2	258	427	2 000	2 600	<b>32024JR</b>	4DC	38.8	132	131	170	161	173	7	9	2	2	0.46	1.31	0.72	3.34
	180	48	48	38	2.5	2	299	540	2 000	2 600	<b>33024JR</b>	2DE	36.2	132	132	170	160	171	6	10	2	2	0.31	1.97	1.08	4.16
	200	62	62	48	2.5	2	462	785	1 800	2 400	<b>33124JR</b>	3FE	47.8	132	133	190	172	192	9	14	2	2	0.40	1.51	0.83	7.73
	215	43.5	40	34	3	2.5	347	473	1 700	2 300	<b>30224JR</b>	4FB	44.2	134	140	203	187	203	6	9.5	2.5	2	0.44	1.38	0.76	6.36
	215	61.5	58	50	3	2.5	470	691	1 700	2 300	<b>32224JR</b>	4FD	51.6	134	136	203	181	204	7	11.5	2.5	2	0.44	1.38	0.76	9.04
	260	59.5	55	38	4	3	430	512	1 200	1 700	<b>30324D</b>	—	77.8	138	145	246	219	239	6	21	3	2.5	0.81	0.74	0.41	13.0
	260	59.5	55	46	4	3	505	611	1 500	2 000	<b>30324</b>	—	48.9	138	152	246	221	239	10	13.5	3	2.5	0.35	1.73	0.95	13.7
	260	59.5	55	46	4	3	569	714	1 500	2 000	<b>30324JR</b>	2GB	50.2	138	152	246	221	239	10	13.5	3	2.5	0.35	1.74	0.96	14.5
	260	68	62	42	4	3	526	665	1 300	1 800	<b>31324JR</b>	7GB	81.9	138	145	246	221	244	6	21	3	2.5	0.83	0.73	0.40	15.4
	260	90.5	86	69	4	3	800	1 110	1 500	2 000	<b>32324JR</b>	2GD	62.7	138	148	246	213	239	9	21.5	3	2.5	0.35	1.74	0.96	22.2
	260	90.5	86	69	4	3	797	1 110	1 500	2 000	<b>32324R</b>	—	61.1	138	148	246	213	239	9	21.5	3	2.5	0.35	1.73	0.95	21.8

Single-row tapered roller bearings  
metric series

d 130 ~ (150) mm

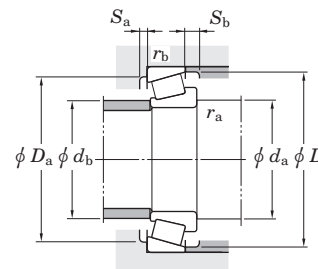
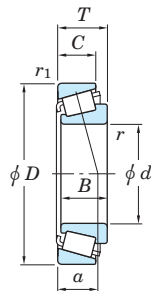

Boundary dimensions (mm)							Basic load ratings (kN)		Limiting speeds (min <sup>-1</sup> )		Bearing No.	Dimension series to ISO355 (Refer.)	Load center (mm) a	Mounting dimensions (mm)								Constant e	Axial load factors		(Refer.) Mass (kg)	
d	D	T	B	C	r min.	r1 min.	Cr	C0r	Grease lub.	Oil lub.				da min.	db max.	Da max.	Db min.	Sa min.	Sb min.	ra max.	rb max.		Y1	Y0		
130	180	32	32	25	2	1.5	200	368	1 900	2 500	32926JR	2CC	31.4	140	141	171	165	174	6	7	2	1.5	0.34	1.77	0.97	2.42
	185	29	27	21	3	3	183	282	1 800	2 500	T4CB130	4CB	37.8	144	141	171	170	179	5	8	2.5	2.5	0.47	1.27	0.70	2.22
	200	45	45	34	2.5	2	340	563	1 800	2 300	32026JR	4EC	42.9	142	144	190	178	192	8	11	2	2	0.43	1.38	0.76	5.04
	200	55	55	43	2.5	2	390	705	1 700	2 300	33026JR	2EE	42.5	142	143	190	178	192	8	12	2	2	0.34	1.76	0.97	6.19
	230	43.75	40	34	4	3	377	511	1 600	2 100	30226JR	4FB	46.2	148	152	216	203	218	7	9.5	3	2.5	0.44	1.38	0.76	7.24
	230	67.75	64	54	4	3	554	830	1 600	2 200	32226JR	4FD	56.0	148	146	216	193	219	7	13.5	3	2.5	0.44	1.38	0.76	11.5
	280	63.75	58	41	5	4	485	582	1 200	1 600	30326D	—	84.0	152	155	262	240	261	7	22	4	3	0.81	0.74	0.41	16.3
	280	63.75	58	49	5	4	657	834	1 400	1 800	30326JR	2GB	54.0	152	164	262	239	255	8	14.5	4	3	0.35	1.74	0.96	18.1
	280	72	66	44	5	4	589	748	1 200	1 600	31326JR	7GB	87.3	152	155	262	236	261	7	23	4	3	0.83	0.73	0.40	18.9
	280	98.75	93	78	5	4	852	1 160	1 400	1 800	32326	—	69.1	152	163	262	226	259	10	15	4	3	0.35	1.73	0.95	26.5
140	190	32	32	25	2	1.5	206	390	1 800	2 300	32928JR	2CC	33.6	150	150	181	174	184	6	7	2	1.5	0.36	1.67	0.92	2.57
	195	29	27	21	3	3	185	293	1 700	2 300	T4CB140	4CB	40.9	154	151	181	180	189	5	8	2.5	2.5	0.50	1.19	0.66	2.36
	210	45	45	34	2.5	2	346	585	1 700	2 200	32028JR	4DC	45.6	152	153	200	187	202	8	11	2	2	0.46	1.31	0.72	5.28
	210	56	56	44	2.5	2	406	758	1 600	2 200	33028JR	2DE	45.6	152	152	200	186	202	7	12	2	2	0.36	1.67	0.92	6.61
	250	45.75	42	36	4	3	420	570	1 500	1 900	30228JR	4FB	49.4	158	163	236	219	237	9	9.5	3	2.5	0.44	1.38	0.76	8.97
	250	71.75	68	58	4	3	636	961	1 500	2 000	32228JR	4FD	60.0	158	158	236	210	238	9	13.5	3	2.5	0.44	1.38	0.76	14.7
	300	67.75	62	44	5	4	525	627	1 100	1 500	30328D	—	90.2	162	169	282	254	280	7	23	4	3	0.81	0.74	0.41	20.0
	300	67.75	62	53	5	4	749	962	1 300	1 700	30328JR	2GB	56.9	162	179	282	254	273	10	14.5	4	3	0.35	1.74	0.96	22.6
	300	77	70	47	5	4	674	865	1 100	1 500	31328JR	7GB	93.8	162	167	282	254	280	8	26	4	3	0.83	0.73	0.40	23.3
	300	107.75	102	85	5	4	1 110	1 570	1 300	1 700	32328R	—	74.2	162	175	282	246	280	10	17	4	3	0.35	1.74	0.96	35.1
150	210	38	38	30	2.5	2	286	536	1 600	2 100	32930JR	2DC	36.1	162	163	200	194	202	7	8	2	2	0.33	1.83	1.01	3.96
	225	48	48	36	3	2.5	391	668	1 500	2 000	32030JR	4EC	48.8	164	164	213	200	216	8	12	2.5	2	0.46	1.31	0.72	6.41
	225	59	59	46	3	2.5	459	869	1 500	2 000	33030JR	2EE	47.8	164	164	213	200	217	8	13	2.5	2	0.36	1.65	0.90	8.09
	270	49	45	38	4	3	483	664	1 300	1 800	30230JR	4GB	52.4	168	175	256	234	255	9	11	3	2.5	0.44	1.38	0.76	11.6
	270	77	73	60	4	3	704	1 070	1 300	1 800	32230JR	4GD	65.2	168	170	256	226	254	8	17	3	2.5	0.44	1.38	0.76	18.2
	320	72	65	46	5	4	616	750	970	1 400	30330D	—	96.0	172	183	302	270	301	9	26	4	3	0.81	0.74	0.41	23.9
	320	72	65	55	5	4	837	1 080	1 200	1 500	30330JR	2GB	60.8	172	193	302	272	292	12	17	4	3	0.35	1.74	0.96	26.6

Single-row tapered roller bearings  
metric series

$d$  (150) ~ (190) mm

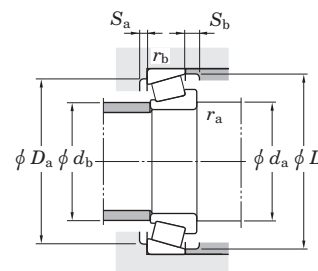
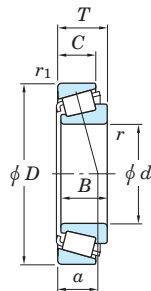

Boundary dimensions (mm)							Basic load ratings (kN)		Limiting speeds (min <sup>-1</sup> )		Bearing No.	Dimension series to ISO355 (Refer.)	Load center (mm) a	Mounting dimensions (mm)								Constant e	Axial load factors		(Refer.) Mass (kg)	
d	D	T	B	C	r min.	r1 min.	Cr	C0r	Grease lub.	Oil lub.				da min.	db max.	Da max.	Db min.	Sa min.	Sb min.	ra max.	rb max.		Y1	Y0		
150	320	82	75	50	5	4	763	989	980	1 400	31330JR 32330R	7GB	100.1	172	179	302	272	301	9	27	4	3	0.83	0.73	0.40	28.0
	320	114	108	90	5	4	1 240	1 790	1 200	1 600		—	78.4	172	187	302	263	298	10	17	4	3	0.35	1.74	0.96	42.0
160	220	32	30	23	3	3	225	379	1 500	2 000	T4DB160 32932JR 32032JR	4DB	44.7	174	172	206	204	213	5	9	2.5	2.5	0.49	1.23	0.68	3.23
	220	38	38	30	2.5	2	295	568	1 500	2 000		2DC	38.4	172	173	210	204	212	7	8	2	2	0.35	1.73	0.95	4.19
	240	51	51	38	3	2.5	440	758	1 400	1 900	4EC	52.1	174	175	228	213	231	8	13	2.5	2	0.46	1.31	0.72	7.75	
	290	52	48	40	4	3	542	750	1 200	1 600	30232JR	4GB	56.3	178	189	276	252	269	8	12	3	2.5	0.44	1.38	0.76	14.1
	290	84	80	67	4	3	795	1 210	1 200	1 700	32232JR	4GD	70.3	178	182	276	242	274	10	17	3	2.5	0.44	1.38	0.76	23.2
	340	75	68	48	5	4	742	933	900	1 300	30332D	—	101.8	182	195	322	290	320	9	27	4	3	0.81	0.74	0.41	29.1
	340	75	68	58	5	4	938	1 220	1 100	1 400	30332JR	2GB	63.3	182	205	322	289	310	12	17	4	3	0.35	1.74	0.96	31.8
340	121	114	95	5	4	1 220	1 720	1 100	1 400	32332	—	83.0	182	200	322	277	316	10	18	4	3	0.35	1.73	0.95	47.9	
170	230	38	38	30	2.5	2	296	606	1 400	1 900	32934JR 32034JR 30234JR	3DC	42.0	182	183	220	213	222	7	8	2	2	0.38	1.57	0.86	4.49
	260	57	57	43	3	2.5	526	905	1 300	1 700		4EC	55.8	184	187	248	230	249	10	14	2.5	2	0.44	1.35	0.74	10.5
	310	57	52	43	5	4	620	867	1 100	1 500	4GB	61.2	192	202	292	269	288	8	14	4	3	0.44	1.38	0.76	17.8	
	310	91	86	71	5	4	898	1 380	1 100	1 500	32234JR	4GD	76.2	192	195	292	259	294	10	20	4	3	0.44	1.38	0.76	28.9
	360	80	72	50	5	4	762	1 040	830	1 200	30334D	—	108.3	192	211	342	310	333	9	30	4	3	0.81	0.74	0.41	34.3
	360	80	72	62	5	4	1 040	1 370	1 000	1 300	30334JR	2GB	67.9	192	218	342	306	329	13	18	4	3	0.35	1.74	0.96	37.5
	360	127	120	100	5	4	1 310	1 830	1 000	1 300	32334	—	86.1	192	200	342	295	337	14	26	4	3	0.35	1.73	0.95	56.9
180	250	45	45	34	2.5	2	357	735	1 300	1 700	32936JR 32036JR 30236JR	4DC	53.5	192	193	240	225	241	8	11	2	2	0.48	1.25	0.69	6.64
	280	64	64	48	3	2.5	644	1 100	1 200	1 600		3FD	59.5	194	199	268	247	268	10	16	2.5	2	0.42	1.42	0.78	14.1
	320	57	52	43	5	4	615	870	1 100	1 400	4GB	63.6	202	211	302	278	297	9	14	4	3	0.45	1.33	0.73	18.3	
	320	91	86	71	5	4	957	1 520	1 100	1 500	32236JR	4GD	77.8	202	204	302	267	303	10	20	4	3	0.45	1.33	0.73	29.9
	380	83	75	52	5	4	833	1 150	780	1 100	30336D	—	112.8	202	225	362	330	351	10	31	4	3	0.81	0.74	0.41	40.1
	380	83	75	64	5	4	901	1 110	940	1 300	30336	—	71.0	202	227	362	318	346	13	19	4	3	0.35	1.73	0.95	39.7
	380	134	126	106	5	4	1 410	1 980	960	1 300	32336	—	91.8	202	215	362	310	355	14	27	4	3	0.35	1.73	0.95	67.0
190	260	45	45	34	2.5	2	366	789	1 200	1 600	32938JR 32038JR	4DC	55.0	202	204	250	235	252	8	11	2	2	0.48	1.26	0.69	6.89
	290	64	64	48	3	2.5	654	1 170	1 100	1 500		4FD	62.9	204	209	278	257	279	10	16	2.5	2	0.44	1.36	0.75	14.7

Single-row tapered roller bearings  
metric series

$d$  (190) ~ 260 mm

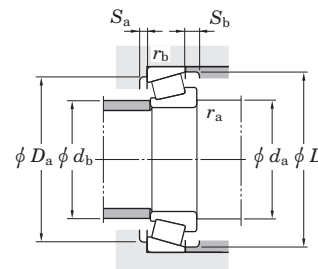
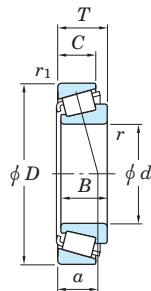

Boundary dimensions (mm)							Basic load ratings (kN)		Limiting speeds (min <sup>-1</sup> )		Bearing No.	Dimension series to ISO355 (Refer.)	Load center (mm) a	Mounting dimensions (mm)								Constant e	Axial load factors		(Refer.) Mass (kg)		
d	D	T	B	C	r min.	r1 min.	C <sub>r</sub>	C <sub>0r</sub>	Grease lub.	Oil lub.				d <sub>a</sub> min.	d <sub>b</sub> max.	D <sub>a</sub> max.	D <sub>b</sub> min.	S <sub>a</sub> min.	S <sub>b</sub> min.	r <sub>a</sub> max.	r <sub>b</sub> max.		Y <sub>1</sub>	Y <sub>0</sub>			
<b>190</b>	340	60	55	46	5	4	729	1 030	1 000	1 300	<b>30238JR</b>	4GB	66.4	212	225	322	298	318	12	13	4	3	0.44	1.38	0.76	21.9	
	340	97	92	75	5	4	1 090	1 740	1 000	1 300		4GD	81.9	212	216	322	286	323	12	22	4	3	0.44	1.38	0.76	36.6	
	400	86	78	52	6	5	950	1 210	740	1 000		—	119.2	218	232	378	350	372	11	34	5	4	0.81	0.74	0.41	44.8	
	400	86	78	65	6	5	1 010	1 250	880	1 200		<b>30338</b>	—	73.2	218	241	378	342	370	10	20	5	4	0.35	1.73	0.95	46.2
	400	140	132	109	6	5	1 550	2 190	890	1 200		<b>32338</b>	—	96.5	218	225	378	330	375	14	30	5	4	0.35	1.73	0.95	76.6
<b>200</b>	280	51	51	39	3	2.5	486	958	1 100	1 500	<b>32940JR</b>	3EC	53.6	214	216	268	257	271	9	12	2.5	2	0.39	1.52	0.84	9.44	
	310	70	70	53	3	2.5	755	1 340	1 100	1 400		4FD	66.9	214	221	298	273	297	11	17	2.5	2	0.43	1.39	0.77	19.1	
	360	64	58	48	5	4	792	1 120	940	1 200		4GB	70.3	222	238	342	315	336	12	15	4	3	0.44	1.38	0.76	26.4	
	360	104	98	82	5	4	1 240	1 880	960	1 300		<b>32240JR</b>	3GD	84.6	222	225	342	302	340	11	22	4	3	0.41	1.48	0.81	44.2
	420	89	80	56	6	5	904	1 230	690	970		<b>30340D</b>	—	122.6	228	248	398	365	385	11	33	5	4	0.81	0.74	0.41	50.6
	420	89	80	67	6	5	1 120	1 450	820	1 100		<b>30340</b>	—	79.8	228	255	398	354	385	11	21	5	4	0.35	1.73	0.95	53.5
	420	146	138	115	6	5	1 790	2 580	830	1 100		<b>32340</b>	—	102.9	228	240	398	345	395	16	30	5	4	0.35	1.73	0.95	91.0
<b>220</b>	300	51	51	39	3	2.5	498	1 010	1 000	1 400	<b>32944JR</b>	3EC	58.6	234	234	288	275	290	9	12	2.5	2	0.43	1.41	0.78	10.1	
	340	76	76	57	4	3	894	1 620	940	1 300		4FD	72.8	238	243	326	300	326	12	19	3	2.5	0.43	1.39	0.77	25.2	
	400	72	65	54	5	4	1 010	1 440	830	1 100		—	76.5	242	263	382	344	371	14	17	4	3	0.44	1.43	0.79	35.9	
	400	114	108	90	5	4	1 190	1 930	830	1 100		<b>32244</b>	—	95.9	242	260	382	333	377	16	14	4	3	0.43	1.39	0.77	56.8
	460	97	88	73	6	5	1 260	1 680	730	980		<b>30344</b>	—	84.6	248	282	438	386	420	12	23	5	4	0.35	1.73	0.95	69.0
<b>240</b>	320	51	51	39	3	2.5	515	1 090	940	1 300	<b>32948JR</b>	4EC	64.5	254	254	308	294	311	9	12	2.5	2	0.46	1.31	0.72	10.9	
	360	76	76	57	4	3	924	1 720	870	1 200		4FD	78.5	258	261	346	318	346	12	19	3	2.5	0.46	1.31	0.72	26.8	
	440	79	72	60	5	4	1 230	1 790	730	980		—	82.7	262	287	422	377	409	14	18	4	3	0.42	1.43	0.79	49.5	
	440	127	120	100	5	4	1 530	2 480	740	980		<b>32248</b>	—	106.1	262	282	422	365	415	16	14	4	3	0.43	1.39	0.77	76.4
<b>260</b>	360	63.5	63.5	48	3	2.5	741	1 550	830	1 100	<b>32952JR</b>	3EC	69.6	274	279	348	328	347	11	15.5	2.5	2	0.41	1.48	0.81	18.9	
	400	87	87	65	5	4	1 170	2 170	770	1 000		4FC	85.0	282	287	382	352	383	14	22	4	3	0.43	1.38	0.76	39.5	
	480	89	80	67	6	5	1 210	1 860	650	870		—	93.6	288	310	458	415	450	14	21	5	4	0.42	1.44	0.79	64.9	
	480	137	130	106	6	5	1 760	2 870	660	880		<b>32252</b>	—	115.2	288	300	458	400	455	16	30	5	4	0.43	1.39	0.77	102



Single-row tapered roller bearings  
metric series

d 280 ~ 360 mm

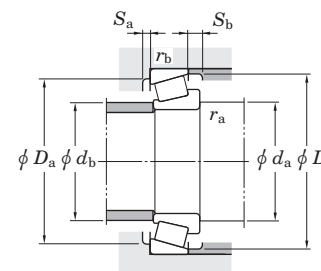
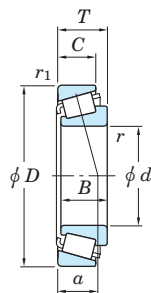

Boundary dimensions (mm)							Basic load ratings (kN)		Limiting speeds (min <sup>-1</sup> )		Bearing No.	Dimension series to ISO355 (Refer.)	Load center (mm) a	Mounting dimensions (mm)								Constant e	Axial load factors		(Refer.) Mass (kg)	
d	D	T	B	C	r min.	r1 min.	Cr	C0r	Grease lub.	Oil lub.				da min.	db max.	Da max.	Db min.	Sa min.	Sb min.	ra max.	rb max.		Y1	Y0		
<b>280</b>	380	63.5	63.5	48	3	2.5	760	1 630	770	1 000	<b>32956JR</b>	4EC	75.1	294	298	368	347	368	11	15.5	2.5	2	0.43	1.39	0.76	20.1
	420	87	87	65	5	4	1 200	2 280	720	960	<b>32056JR</b>	4FC	91.1	302	305	402	370	402	14	22	4	3	0.46	1.31	0.72	41.7
	500	89	80	67	6	5	1 260	1 920	610	810	<b>30256</b>	—	96.2	308	325	478	440	475	14	21	5	4	0.42	1.44	0.79	67.6
	500	137	130	106	6	5	1 860	3 150	610	810	<b>32256</b>	—	117.2	308	325	478	420	474	16	30	5	4	0.43	1.39	0.77	108
<b>300</b>	420	76	76	57	4	3	1 050	2 210	680	910	<b>32960JR</b>	3FD	79.9	318	324	406	383	405	12	19	3	2.5	0.39	1.52	0.84	32.4
	460	100	100	74	5	4	1 430	2 660	640	850	<b>32060JR</b>	4GD	97.9	322	329	442	404	439	15	26	4	3	0.43	1.38	0.76	57.5
	540	96	85	71	6	5	1 510	2 360	550	730	<b>30260</b>	—	103.9	328	350	518	475	505	14	24	5	4	0.42	1.44	0.79	84.7
<b>320</b>	440	76	76	57	4	3	1 060	2 270	640	850	<b>32964JR</b>	3FD	85.0	338	342	426	401	426	12	19	3	2.5	0.42	1.44	0.79	34.0
	480	100	100	74	5	4	1 510	2 810	600	800	<b>32064JR</b>	4GD	103.0	342	344	462	418	461	16	26	4	3	0.46	1.31	0.72	58.7
	580	104	92	75	6	5	1 740	2 770	490	660	<b>30264</b>	—	111.9	348	370	558	505	540	14	28	5	4	0.42	1.44	0.79	108
<b>340</b>	460	76	76	57	4	3	1 070	2 340	590	790	<b>32968JR</b>	4FD	90.5	358	361	446	420	446	12	19	3	2.5	0.44	1.37	0.75	35.6
<b>360</b>	480	76	76	57	4	3	1 080	2 400	560	740	<b>32972JR</b>	4FD	96.2	378	379	466	438	466	12	19	3	2.5	0.46	1.31	0.72	37.1

Single-row tapered roller bearings  
inch series

$d$  9.525 ~ (22.225) mm

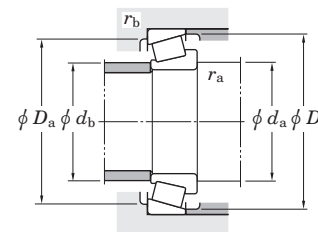
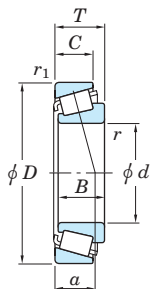

Boundary dimensions (mm)							Basic load ratings (kN)		Limiting speeds (min <sup>-1</sup> )		Bearing No.	Load center (mm) a	Mounting dimensions (mm)						Constant e	Axial load factors		(Refer.) Mass (kg)		
d	D	T	B	C	r <sub>min.</sub>	r <sub>1 min.</sub>	C <sub>r</sub>	C <sub>0r</sub>	Grease lub.	Oil lub.			Inner ring	Outer ring	d <sub>a</sub>	d <sub>b</sub>	D <sub>a</sub>	D <sub>b</sub>		r <sub>a max.</sub>	r <sub>b max.</sub>	Y <sub>1</sub>	Y <sub>0</sub>	Inner ring
<b>9.525</b>	31.991	10.008	10.785	7.938	1.2	1.2	10.7	9.30	14 000	19 000	<b>A2037</b>	<b>A2126</b>	7.1	15.0	13.5	26.0	29.0	1.2	1.2	0.40	1.48	0.82	0.029	0.017
<b>11.986</b>	31.991	10.008	10.785	7.938	0.8	1.2	10.7	9.30	14 000	19 000	<b>A2047</b>	<b>A2126</b>	7.1	16.5	15.5	26.0	29.0	0.8	1.2	0.40	1.48	0.82	0.023	0.017
<b>12.700</b>	34.988	10.998	10.988	8.730	1.2	1.2	12.6	11.9	12 000	17 000	<b>A4050</b>	<b>A4138</b>	8.3	18.5	17.0	29.0	32.0	1.2	1.2	0.45	1.33	0.73	0.033	0.022
<b>14.989</b>	34.988	10.998	10.988	8.730	0.8	1.2	12.6	11.9	12 000	17 000	<b>A4059</b>	<b>A4138</b>	8.3	19.5	19.0	29.0	32.0	0.8	1.2	0.45	1.33	0.73	0.029	0.022
<b>15.875</b>	34.988	10.998	10.998	8.712	1.2	1.2	14.5	14.3	12 000	16 000	<b>L21549</b>	<b>L21511</b>	7.6	21.5	19.5	29.0	32.5	1.2	1.2	0.32	1.88	1.04	0.031	0.018
	41.275	14.288	14.681	11.112	1.2	2.0	21.8	20.5	11 000	14 000	<b>03062</b>	<b>03162</b>	9.3	21.5	20.0	34.0	37.5	1.2	2.0	0.31	1.93	1.06	0.060	0.035
	42.862	16.670	16.670	13.495	1.6	1.6	30.6	29.5	10 000	14 000	<b>17580R</b>	<b>17520</b>	10.9	23.0	21.0	36.5	39.0	1.6	1.6	0.33	1.81	1.00	0.078	0.048
	49.225	19.845	21.539	14.288	0.8	1.2	37.7	37.7	8 900	12 000	<b>09062</b>	<b>09195</b>	10.6	22.0	21.5	42.0	44.5	0.8	1.2	0.27	2.26	1.24	0.139	0.065
	53.975	22.225	21.839	15.875	0.8	2.4	42.0	41.2	8 400	11 000	<b>21063</b>	<b>21212</b>	16.6	29.0	26.5	43.0	50.0	0.8	2.4	0.59	1.02	0.56	0.163	0.097
<b>16.000</b>	47.000	21.000	21.000	16.000	1.0	2.0	36.3	37.7	9 800	13 000	<b>HM81649</b>	<b>HM81610</b>	15.0	27.5	23.0	37.5	43.0	1.0	2.0	0.55	1.10	0.60	0.111	0.080
<b>17.462</b>	39.878	13.843	14.605	10.668	1.2	1.2	25.4	26.0	11 000	14 000	<b>LM11749R</b>	<b>LM11710</b>	8.6	23.0	21.5	34.0	37.0	1.2	1.2	0.29	2.10	1.15	0.058	0.028
<b>19.050</b>	45.237	15.494	16.637	12.065	1.2	1.2	29.4	30.1	9 400	13 000	<b>LM11949</b>	<b>LM11910</b>	10.0	25.0	23.5	39.5	41.5	1.2	1.2	0.30	2.00	1.10	0.081	0.044
	49.225	19.845	21.539	14.288	1.2	1.2	37.7	37.7	8 900	12 000	<b>09078</b>	<b>09195</b>	10.6	25.5	24.0	42.0	44.5	1.2	1.2	0.27	2.26	1.24	0.124	0.065
	49.225	21.209	19.050	17.462	1.2	1.6	37.7	37.7	8 900	12 000	<b>09067</b>	<b>09196</b>	13.8	25.5	24.0	41.5	44.5	1.2	1.6	0.27	2.26	1.24	0.114	0.084
<b>20.000</b>	50.005	13.495	14.260	9.525	1.6	1.0	26.7	28.8	7 900	11 000	<b>07079</b>	<b>07196</b>	10.8	27.5	26.0	44.5	47.0	1.6	1.0	0.40	1.49	0.82	0.104	0.034
<b>20.638</b>	49.225	19.845	19.845	15.875	1.6	1.6	36.4	37.7	8 600	12 000	<b>12580</b>	<b>12520</b>	12.7	28.5	26.0	42.5	45.5	1.6	1.6	0.32	1.86	1.02	0.116	0.067
<b>21.430</b>	50.005	17.526	18.288	13.970	1.2	1.2	39.1	40.7	8 500	11 000	<b>M12649</b>	<b>M12610</b>	11.1	27.5	25.5	44.0	46.0	1.2	1.2	0.28	2.16	1.19	0.119	0.058
<b>21.987</b>	45.974	15.494	16.637	12.065	1.2	1.2	30.1	34.6	8 900	12 000	<b>LM12749</b>	<b>LM12711</b>	10.0	27.5	26.0	40.0	42.5	1.2	1.2	0.31	1.96	1.08	0.078	0.043
<b>22.225</b>	50.005	17.526	18.288	13.970	1.2	1.2	39.1	40.7	8 500	11 000	<b>M12648</b>	<b>M12610</b>	11.1	28.5	26.5	44.0	46.0	1.2	1.2	0.28	2.16	1.19	0.115	0.058
	52.388	19.368	20.168	14.288	1.6	1.6	36.7	37.9	8 000	11 000	<b>1380</b>	<b>1328</b>	11.6	29.5	29.5	45.0	48.5	1.6	1.6	0.29	2.05	1.13	0.132	0.066
	53.975	19.368	20.168	14.288	1.6	1.6	36.7	37.9	8 000	11 000	<b>1380</b>	<b>1329</b>	11.6	29.5	29.5	46.0	49.0	1.6	1.6	0.29	2.05	1.13	0.137	0.082

[Remark] Inch series tapered roller bearings with bore diameter larger than 100 mm are shown in catalog "large size ball & roller bearings".

Single-row tapered roller bearings  
inch series

$d$  (22.225) ~ (26.988) mm

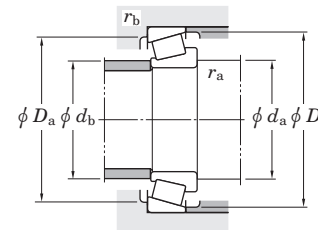
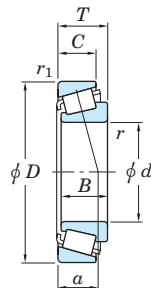

Boundary dimensions (mm)							Basic load ratings (kN)		Limiting speeds (min <sup>-1</sup> )		Bearing No.	Load center (mm) $a$	Mounting dimensions (mm)						Con-stant $e$	Axial load factors		(Refer.) Mass (kg)				
$d$	$D$	$T$	$B$	$C$	$r_{min.}$	$r_{1 min.}$	$C_r$	$C_{0r}$	Grease lub.	Oil lub.			Inner ring	Outer ring	$d_a$	$d_b$	$D_a$	$D_b$		$r_{a max.}$	$r_{b max.}$	$e$	$Y_1$	$Y_0$	Inner ring	Outer ring
<b>22.225</b>	56.896	19.368	19.837	15.875	1.2	1.2	40.0	43.1	7 600	10 000	<b>1755</b>	<b>1729</b>	12.5	29.0	27.5	49.0	51.0	1.2	1.2	0.31	1.95	1.07	0.150	0.100		
	57.150	22.225	22.225	17.462	0.8	1.6	52.6	55.7	7 600	10 000			<b>1280</b>	<b>1220</b>	15.3	29.5	29.0	49.0	52.0	0.8	1.6	0.35	1.73	0.95	0.189	0.105
	66.421	23.812	25.433	19.050	1.6	1.2	67.0	75.2	6 500	8 700			<b>2684</b>	<b>2631</b>	13.9	31.5	29.0	58.0	60.0	1.6	1.2	0.25	2.36	1.30	0.295	0.163
<b>22.606</b>	47.000	15.500	15.500	12.000	1.6	1.0	28.0	32.8	8 700	12 000	<b>LM72849</b>	<b>LM72810</b>	12.3	30.0	28.0	40.5	44.0	1.6	1.0	0.47	1.27	0.70	0.076	0.047		
<b>23.812</b>	50.292	14.224	14.732	10.668	1.6	1.2	31.2	37.0	7 800	10 000	<b>L44640R</b>	<b>L44610</b>	10.8	30.5	28.5	44.5	47.0	1.6	1.2	0.37	1.60	0.88	0.099	0.034		
	56.896	19.368	19.837	15.875	0.8	1.2	40.0	43.1	7 600	10 000			<b>1779</b>	<b>1729</b>	12.5	29.5	28.5	49.0	51.0	0.8	1.2	0.31	1.95	1.07	0.141	0.100
<b>24.981</b>	50.005	13.495	14.260	9.525	1.6	1.0	26.7	28.8	7 900	11 000	<b>07098</b>	<b>07196</b>	10.8	31.0	29.0	44.5	47.0	1.6	1.0	0.40	1.49	0.82	0.084	0.034		
	62.000	16.002	16.566	14.288	1.6	1.6	38.0	40.6	6 700	8 900			<b>17098</b>	<b>17244</b>	12.7	33.0	30.5	54.0	57.0	1.6	1.6	0.38	1.57	0.86	0.162	0.090
<b>25.000</b>	50.005	13.495	14.260	9.525	1.6	1.0	26.7	28.8	7 900	11 000	<b>07097</b>	<b>07196</b>	10.8	31.0	29.0	44.5	47.0	1.6	1.0	0.40	1.49	0.82	0.085	0.035		
<b>25.400</b>	50.005	13.495	14.260	9.525	1.0	1.0	26.7	28.8	7 900	11 000	<b>07100</b>	<b>07196</b>	10.8	30.5	29.5	44.5	47.0	1.0	1.0	0.40	1.49	0.82	0.084	0.035		
	50.005	13.495	14.260	9.525	1.6	1.0	26.7	28.8	7 900	11 000			<b>07100S</b>	<b>07196</b>	10.8	31.5	29.5	44.5	47.0	1.6	1.0	0.40	1.49	0.82	0.082	0.035
	50.292	14.224	14.732	10.668	1.2	1.2	31.2	37.0	7 800	10 000			<b>L44643R</b>	<b>L44610</b>	10.8	31.5	29.5	44.5	47.0	1.2	1.2	0.37	1.60	0.88	0.092	0.039
	51.994	15.011	14.260	12.700	1.0	1.2	26.7	28.8	7 900	11 000			<b>07100</b>	<b>07204</b>	12.3	30.5	29.5	45.0	48.0	1.0	1.2	0.40	1.49	0.82	0.075	0.065
	58.738	19.050	19.355	15.080	1.2	1.2	48.8	57.1	7 000	9 300			<b>1986R</b>	<b>1932</b>	13.1	32.5	30.5	52.0	54.0	1.2	1.2	0.33	1.82	1.00	0.179	0.088
	59.530	23.368	23.114	18.288	0.8	1.6	50.4	57.1	7 200	9 600			<b>M84249</b>	<b>M84210</b>	18.2	36.0	32.5	49.5	56.0	0.8	1.6	0.55	1.10	0.60	0.194	0.128
	61.912	19.050	20.638	14.288	0.8	2.0	44.6	50.7	6 400	8 600			<b>15101</b>	<b>15243</b>	13.2	32.5	31.5	55.0	58.0	0.8	2.0	0.35	1.71	0.94	0.215	0.080
	62.000	19.050	20.638	14.288	3.6	1.2	44.6	50.7	6 400	8 600			<b>15100</b>	<b>15245</b>	13.2	38.0	31.5	55.0	58.0	3.6	1.2	0.35	1.71	0.94	0.215	0.081
	63.500	19.050	20.638	14.288	0.8	1.2	44.6	50.7	6 400	8 600			<b>15101</b>	<b>15250R</b>	13.2	32.5	31.5	55.0	59.0	0.8	1.2	0.35	1.71	0.94	0.215	0.097
	64.292	21.432	21.432	16.670	1.6	1.6	55.2	70.7	6 400	8 500			<b>M86643R</b>	<b>M86610</b>	18.0	38.0	36.5	54.0	61.0	1.6	1.6	0.55	1.10	0.60	0.248	0.127
	66.421	23.812	25.433	19.050	1.2	1.2	67.0	75.2	6 500	8 700			<b>2687</b>	<b>2631</b>	13.9	33.5	31.5	58.0	60.0	1.2	1.2	0.25	2.36	1.30	0.272	0.163
	68.262	22.225	22.225	17.462	0.8	1.6	51.0	61.1	6 000	8 000			<b>02473</b>	<b>02420</b>	17.1	34.5	33.5	59.0	63.0	0.8	1.6	0.42	1.44	0.79	0.275	0.150
	72.233	25.400	25.400	19.842	0.8	2.4	66.9	87.4	5 700	7 600			<b>HM88630</b>	<b>HM88610</b>	20.7	39.5	39.5	60.0	69.0	0.8	2.4	0.55	1.10	0.60	0.391	0.185
<b>26.162</b>	66.421	23.812	25.433	19.050	1.6	1.2	67.0	75.2	6 500	8 700	<b>2682</b>	<b>2631</b>	13.9	34.5	32.0	58.0	60.0	1.6	1.2	0.25	2.36	1.30	0.268	0.163		
<b>26.988</b>	50.292	14.224	14.732	10.668	3.6	1.2	31.2	37.0	7 800	10 000	<b>L44649R</b>	<b>L44610</b>	10.8	37.5	31.0	44.5	47.0	3.6	1.2	0.37	1.60	0.88	0.083	0.039		

[Remark] Inch series tapered roller bearings with bore diameter larger than 100 mm are shown in catalog "large size ball & roller bearings".

Single-row tapered roller bearings  
inch series

$d$  (26.988) ~ (30.162) mm

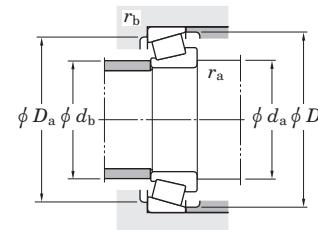
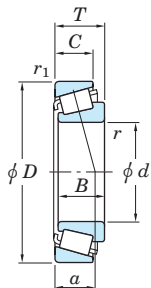

Boundary dimensions (mm)							Basic load ratings (kN)		Limiting speeds (min <sup>-1</sup> )		Bearing No.	Load center (mm) a	Mounting dimensions (mm)						Constant e	Axial load factors		(Refer.) Mass (kg)				
d	D	T	B	C	r min.	r <sub>1</sub> min.	C <sub>r</sub>	C <sub>0r</sub>	Grease lub.	Oil lub.			Inner ring	Outer ring	d <sub>a</sub>	d <sub>b</sub>	D <sub>a</sub>	D <sub>b</sub>		r <sub>a</sub> max.	r <sub>b</sub> max.	Y <sub>1</sub>	Y <sub>0</sub>	Inner ring	Outer ring	
<b>26.988</b>	60.325	19.842	17.462	15.875	3.6	1.6	37.8	42.7	7 000	9 400	<b>15580</b>	<b>15523</b>	15.1	38.5	32.0	51.0	54.0	3.6	1.6	0.35	1.73	0.95	0.140	0.122		
	62.000	19.050	20.638	14.288	0.8	1.2	44.6	50.7	6 400	8 600			<b>15106</b>	<b>15245</b>	13.2	33.5	33.0	55.0	58.0	0.8	1.2	0.35	1.71	0.94	0.206	0.081
	66.421	23.812	25.433	19.050	1.6	1.2	67.0	75.2	6 500	8 700			<b>2688</b>	<b>2631</b>	13.9	35.0	33.0	58.0	60.0	1.6	1.2	0.25	2.36	1.30	0.262	0.163
<b>28.575</b>	57.150	17.462	17.462	13.495	3.6	1.6	37.8	42.7	7 000	9 400	<b>15590</b>	<b>15520</b>	12.7	39.0	33.5	51.0	53.0	3.6	1.6	0.35	1.73	0.95	0.131	0.069		
	57.150	19.845	19.355	15.875	3.6	1.6	48.8	57.1	7 000	9 300			<b>1988R</b>	<b>1922</b>	13.9	39.5	33.5	51.0	53.5	3.6	1.6	0.33	1.82	1.00	0.151	0.076
	62.000	19.050	20.638	14.288	3.6	1.2	44.6	50.7	6 400	8 600			<b>15112</b>	<b>15245</b>	13.2	40.0	34.0	55.0	58.0	3.6	1.2	0.35	1.71	0.94	0.193	0.081
	62.000	19.050	20.638	14.288	0.8	1.2	44.6	50.7	6 400	8 600			<b>15113</b>	<b>15245</b>	13.2	34.5	34.0	55.0	58.0	0.8	1.2	0.35	1.71	0.94	0.195	0.081
	64.292	21.432	21.432	16.670	1.6	1.6	55.2	70.7	6 400	8 500			<b>M86647R</b>	<b>M86610</b>	18.0	40.0	38.0	54.0	61.0	1.6	1.6	0.55	1.10	0.60	0.225	0.127
	66.421	23.812	25.433	19.050	1.2	1.2	67.0	75.2	6 500	8 700			<b>2689</b>	<b>2631</b>	13.9	36.0	34.0	58.0	60.0	1.2	1.2	0.25	2.36	1.30	0.249	0.165
	68.262	22.225	22.225	17.462	0.8	1.6	51.0	61.1	6 000	8 000			<b>02474</b>	<b>02420</b>	17.1	36.5	36.0	59.0	63.0	0.8	1.6	0.42	1.44	0.79	0.252	0.150
	72.000	19.000	18.923	15.875	1.6	1.6	47.5	49.6	5 900	7 800			<b>26112</b>	<b>26283</b>	15.3	37.0	35.0	62.0	65.0	1.6	1.6	0.36	1.67	0.92	0.217	0.163
	72.626	24.608	24.257	17.462	4.8	1.6	61.8	60.5	6 100	8 100			<b>41125</b>	<b>41286</b>	20.7	48.0	36.5	61.0	68.0	4.8	1.6	0.60	1.00	0.55	0.292	0.177
	72.626	24.608	24.257	17.462	1.6	1.6	61.8	60.5	6 100	8 100			<b>41126</b>	<b>41286</b>	20.7	41.5	36.5	61.0	68.0	1.6	1.6	0.60	1.00	0.55	0.295	0.177
	72.626	30.162	29.997	23.812	3.6	3.2	78.8	89.3	5 800	7 700			<b>3192</b>	<b>3120</b>	20.3	42.5	37.0	61.0	67.0	3.6	3.2	0.33	1.80	0.99	0.401	0.222
	72.626	30.162	29.997	23.812	1.2	3.2	78.8	89.3	5 800	7 700			<b>3198</b>	<b>3120</b>	20.3	39.0	37.0	61.0	67.0	1.2	3.2	0.33	1.80	0.99	0.410	0.222
	73.025	22.225	22.225	17.462	0.8	3.2	55.0	65.7	5 500	7 400			<b>02872</b>	<b>02820</b>	18.4	37.5	37.0	62.0	68.0	0.8	3.2	0.45	1.32	0.73	0.319	0.158
<b>29.000</b>	50.292	14.224	14.732	10.668	3.6	1.2	28.9	37.2	7 600	10 000	<b>L45449</b>	<b>L45410</b>	10.9	39.5	33.0	44.5	48.0	3.6	1.2	0.37	1.62	0.89	0.079	0.036		
<b>29.367</b>	66.421	23.812	25.433	19.050	3.6	1.2	67.0	75.2	6 500	8 700	<b>2690</b>	<b>2631</b>	13.9	41.0	35.0	58.0	60.0	3.6	1.2	0.25	2.36	1.30	0.242	0.165		
<b>29.987</b>	62.000	16.002	16.566	14.288	1.6	1.6	38.0	40.6	6 700	8 900	<b>17118</b>	<b>17244</b>	12.7	37.0	34.5	54.0	57.0	1.6	1.6	0.38	1.57	0.86	0.135	0.090		
	62.000	19.050	20.638	14.288	1.2	1.2	44.6	50.7	6 400	8 600			<b>15117</b>	<b>15245</b>	13.2	36.5	35.0	55.0	58.0	1.2	1.2	0.35	1.71	0.94	0.184	0.081
<b>30.000</b>	69.012	19.845	19.583	15.875	3.6	1.2	46.1	55.0	5 900	7 800	<b>14117A</b>	<b>14276</b>	15.5	42.5	39.5	60.0	63.0	3.6	1.2	0.38	1.57	0.86	0.225	0.135		
<b>30.112</b>	62.000	19.050	20.638	14.288	0.8	1.2	44.6	50.7	6 400	8 600	<b>15116</b>	<b>15245</b>	13.2	36.0	35.5	55.0	58.0	0.8	1.2	0.35	1.71	0.94	0.184	0.081		
<b>30.162</b>	62.000	16.002	16.566	14.288	1.6	1.6	38.0	40.6	6 700	8 900	<b>17119</b>	<b>17244</b>	12.7	37.0	34.5	54.0	57.0	1.6	1.6	0.38	1.57	0.86	0.139	0.091		
	64.292	21.432	21.432	16.670	1.6	1.6	55.2	70.7	6 400	8 500			<b>M86649R</b>	<b>M86610</b>	18.0	41.0	38.0	54.0	61.0	1.6	1.6	0.55	1.10	0.60	0.213	0.127

[Remark] Inch series tapered roller bearings with bore diameter larger than 100 mm are shown in catalog "large size ball & roller bearings".

Single-row tapered roller bearings  
inch series

$d$  (30.162) ~ (34.925) mm

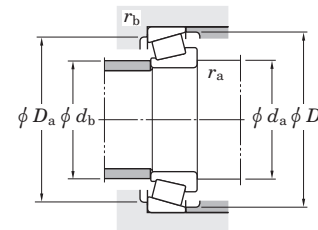
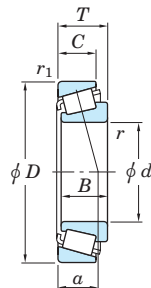

Boundary dimensions (mm)							Basic load ratings (kN)		Limiting speeds (min <sup>-1</sup> )		Bearing No.	Load center (mm)	Mounting dimensions (mm)						Con-stant	Axial load factors		(Refer.) Mass (kg)		
$d$	$D$	$T$	$B$	$C$	$r_1$ <sup>1)</sup> min.	$r_1$ min.	$C_r$	$C_{0r}$	Grease lub.	Oil lub.			Inner ring	Outer ring	$a$	$d_a$	$d_b$	$D_a$		$D_b$	$r_a$ max.	$r_b$ max.	$e$	$Y_1$
<b>30.162</b>	68.262	22.225	22.225	17.462	2.4	1.6	56.1	71.1	6 000	7 900	<b>M88043</b>	<b>M88010</b>	19.2	43.5	39.5	58.0	65.0	2.4	1.6	0.55	1.10	0.60	0.258	0.144
<b>30.213</b>	62.000	19.050	20.638	14.288	3.6	1.2	44.6	50.7	6 400	8 600	<b>15118</b>	<b>15245</b>	13.2	41.5	35.5	55.0	58.0	3.6	1.2	0.35	1.71	0.94	0.181	0.081
	62.000	19.050	20.638	14.288	1.6	1.2	44.6	50.7	6 400	8 600	<b>15119</b>	<b>15245</b>	13.2	37.5	35.5	55.0	58.0	1.6	1.2	0.35	1.71	0.94	0.183	0.081
	62.000	19.050	20.638	14.288	0.8	1.2	44.6	50.7	6 400	8 600	<b>15120</b>	<b>15245</b>	13.2	36.0	35.5	55.0	58.0	0.8	1.2	0.35	1.71	0.94	0.183	0.081
<b>30.226</b>	69.012	19.845	19.583	15.875	0.8	3.2	46.1	55.0	5 900	7 800	<b>14116</b>	<b>14274</b>	15.5	37.0	36.5	59.0	63.0	0.8	3.2	0.38	1.57	0.86	0.226	0.131
<b>31.750</b>	58.738	14.684	15.080	10.716	1.0	1.0	29.5	33.3	6 600	8 900	<b>08125</b>	<b>08231</b>	13.5	37.5	36.0	52.0	55.0	1.0	1.0	0.48	1.26	0.69	0.109	0.056
	59.131	15.875	16.764	11.811	SP	1.2	35.8	43.1	6 600	8 800	<b>LM67048</b>	<b>LM67010</b>	13.0	42.5	36.0	52.0	56.0	3.5	1.2	0.41	1.46	0.80	0.120	0.062
	62.000	18.161	19.050	14.288	SP	1.2	44.6	50.7	6 400	8 600	<b>15123</b>	<b>15245</b>	13.2	42.5	36.5	55.0	58.0	3.5	1.2	0.35	1.71	0.94	0.157	0.081
	62.000	19.050	20.638	14.288	3.6	1.2	44.6	50.7	6 400	8 600	<b>15125</b>	<b>15245</b>	13.2	42.5	36.5	55.0	58.0	3.6	1.2	0.35	1.71	0.94	0.169	0.081
	62.000	19.050	20.638	14.288	0.8	1.2	44.6	50.7	6 400	8 600	<b>15126</b>	<b>15245</b>	13.2	37.0	36.5	55.0	58.0	0.8	1.2	0.35	1.71	0.94	0.171	0.081
	66.421	25.400	25.357	20.638	0.8	3.2	71.4	85.1	6 000	8 000	<b>2580</b>	<b>2520</b>	16.0	38.5	37.5	57.0	62.5	0.8	3.2	0.27	2.19	1.21	0.281	0.123
	68.262	22.225	22.225	17.462	3.6	1.6	51.0	61.1	6 000	8 000	<b>02475</b>	<b>02420</b>	17.1	44.5	38.5	59.0	63.0	3.6	1.6	0.42	1.44	0.79	0.224	0.150
	68.262	22.225	22.225	17.462	0.8	1.6	51.0	61.1	6 000	8 000	<b>02476</b>	<b>02420</b>	17.1	39.0	38.5	59.0	63.0	0.8	1.6	0.42	1.44	0.79	0.226	0.150
	68.262	22.225	22.225	17.462	1.6	1.6	56.1	71.1	6 000	7 900	<b>M88046</b>	<b>M88010</b>	19.2	43.0	40.5	58.0	65.0	1.6	1.6	0.55	1.10	0.60	0.245	0.144
	73.025	22.225	22.225	17.462	3.6	3.2	55.0	65.7	5 600	7 400	<b>02875</b>	<b>02820</b>	17.1	45.5	39.5	62.0	68.0	3.6	3.2	0.45	1.32	0.73	0.293	0.158
	73.025	22.225	22.225	17.462	0.8	3.2	55.0	65.7	5 500	7 400	<b>02876</b>	<b>02820</b>	17.1	40.0	39.5	62.0	68.0	0.8	3.2	0.45	1.32	0.73	0.293	0.158
	73.025	29.370	27.783	23.020	1.2	3.2	74.3	101	5 600	7 500	<b>HM88542</b>	<b>HM88510</b>	23.4	45.5	42.5	59.0	70.0	1.2	3.2	0.55	1.10	0.60	0.377	0.238
	73.812	29.370	27.783	23.020	1.2	3.2	74.3	101	5 600	7 500	<b>HM88542</b>	<b>HM88512</b>	23.4	45.5	42.5	59.0	70.0	1.2	3.2	0.55	1.10	0.60	0.377	0.254
<b>33.338</b>	68.262	22.225	22.225	17.462	0.8	1.6	56.1	71.1	6 000	7 900	<b>M88048</b>	<b>M88010</b>	19.2	42.5	41.0	58.0	65.0	0.8	1.6	0.55	1.10	0.60	0.231	0.144
	72.000	19.000	18.923	15.875	3.6	1.6	47.5	49.6	5 900	7 800	<b>26131</b>	<b>26283</b>	15.3	44.5	38.5	62.0	65.0	3.6	1.6	0.36	1.67	0.92	0.200	0.163
	73.025	29.370	27.783	23.020	0.8	3.2	74.3	101	5 600	7 500	<b>HM88547</b>	<b>HM88510</b>	23.4	45.5	42.6	59.0	70.0	0.8	3.2	0.55	1.10	0.60	0.360	0.238
	76.200	29.370	28.575	23.020	0.8	3.2	79.5	107	5 400	7 200	<b>HM89443</b>	<b>HM89410</b>	23.9	46.5	44.6	62.0	73.0	0.8	3.2	0.55	1.10	0.60	0.415	0.254
<b>34.925</b>	65.088	18.034	18.288	13.970	SP	1.2	48.0	58.5	6 000	8 000	<b>LM48548</b>	<b>LM48510</b>	14.3	46.0	40.0	58.0	61.0	3.5	1.2	0.38	1.59	0.88	0.164	0.086
	69.012	26.982	26.721	15.875	0.8	1.2	46.1	55.0	5 900	7 800	<b>14136A</b>	<b>14276</b>	22.6	40.0	38.0	60.0	63.0	0.8	1.2	0.38	1.57	0.86	0.254	0.133
	72.233	25.400	25.400	19.842	2.4	2.4	66.9	87.4	5 700	7 600	<b>HM88649</b>	<b>HM88610</b>	20.7	48.5	42.5	60.0	69.0	2.4	2.4	0.55	1.10	0.60	0.301	0.185

[Note] 1) SP indicates the specially chamfered from.

[Remark] Inch series tapered roller bearings with bore diameter larger than 100 mm are shown in catalog "large size ball & roller bearings".

Single-row tapered roller bearings  
inch series

$d$  (34.925) ~ (38.100) mm

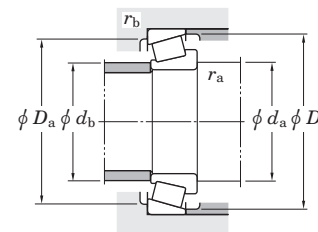
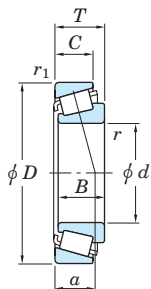

Boundary dimensions (mm)							Basic load ratings (kN)		Limiting speeds (min <sup>-1</sup> )		Bearing No. <sup>2)</sup>	Load center (mm) $a$	Mounting dimensions (mm)				Constant $e$	Axial load factors		(Refer.) Mass (kg)						
$d$	$D$	$T$	$B$	$C$	$r_1^{1)}$ min.	$r_1^{1)}$ min.	$C_r$	$C_{0r}$	Grease lub.	Oil lub.			Inner ring	Outer ring	$d_a$	$d_b$		$D_a$	$D_b$	$r_a$ max.	$r_b$ max.	$Y_1$	$Y_0$	Inner ring	Outer ring	
34.925	72.238	20.638	20.638	15.875	3.6	1.2	49.7	61.3	5 600	7 400	16137	16284	16.6	46.5	40.5	63.0	67.0	3.6	1.2	0.40	1.49	0.82	0.236	0.144		
	73.025	22.225	22.225	17.462	3.6	3.2	55.0	65.7	5 500	7 400			02877	02820	18.4	48.5	42.0	62.0	68.0	3.6	3.2	0.45	1.32	0.73	0.262	0.158
	73.025	22.225	22.225	17.462	0.8	3.2	55.0	65.7	5 500	7 400			02878	02820	18.4	42.5	42.0	62.0	68.0	0.8	3.2	0.45	1.32	0.73	0.265	0.158
	73.025	23.812	24.608	19.050	1.6	0.8	72.2	87.3	5 600	7 400	25877R	25821	15.8	43.0	40.5	65.0	68.0	1.6	0.8	0.29	2.07	1.14	0.310	0.165		
	73.025	26.988	26.975	22.225	3.6	1.6	77.8	94.1	5 700	7 600	23690	23620	18.8	49.0	42.0	64.0	68.0	3.6	1.6	0.37	1.62	0.89	0.326	0.212		
	76.200	20.638	20.940	15.507	1.6	1.2	57.3	65.9	5 300	7 000	28137	28300	16.5	43.5	41.0	68.0	71.0	1.6	1.2	0.40	1.49	0.82	0.315	0.137		
	76.200	23.812	25.654	19.050	3.6	3.2	74.1	92.2	5 400	7 200	2796R	2720	15.9	47.5	41.0	66.0	70.0	3.6	3.2	0.30	1.98	1.09	0.344	0.185		
	76.200	29.370	28.575	23.812	1.6	3.2	80.9	97.4	5 400	7 200	31594	31520	21.6	46.0	43.5	64.0	72.0	1.6	3.2	0.40	1.49	0.82	0.388	0.232		
	79.375	29.370	29.771	23.812	3.6	3.2	87.4	105	5 200	6 900	3478	3420	20.8	50.0	43.5	67.0	74.0	3.6	3.2	0.37	1.64	0.90	0.462	0.256		
	87.312	30.162	30.886	23.812	3.6	3.2	95.8	120	4 600	6 200	3581R	3525	20.5	48.0	45.5	75.0	81.0	3.6	3.2	0.31	1.96	1.08	0.622	0.300		
	95.250	27.783	29.901	22.225	0.8	2.4	103	122	4 500	5 900	449	432	18.4	44.0	43.5	83.0	87.0	0.8	2.4	0.28	2.11	1.16	0.686	0.384		
	34.980	59.131	15.875	16.764	11.938	SP	1.2	35.7	48.5	6 400	8 500	L68149	L68110	13.2	45.5	39.0	53.0	56.0	3.5	1.2	0.42	1.44	0.79	0.112	0.056	
59.975		15.875	16.764	11.938	SP	1.2	35.7	48.5	6 400	8 500	L68149	L68111	13.2	45.5	39.0	53.0	56.0	3.5	1.2	0.42	1.44	0.79	0.112	0.063		
35.000	79.375	23.812	25.400	19.050	0.8	0.8	81.1	105	5 000	6 700	26883R	26822	16.4	42.5	42.0	71.0	74.0	0.8	0.8	0.32	1.88	1.04	0.414	0.186		
	80.000	21.000	22.403	17.826	0.8	1.2	68.0	74.8	4 900	6 600	339	332	15.1	42.5	41.5	73.0	75.0	0.8	1.2	0.27	2.20	1.21	0.385	0.144		
35.717	72.233	25.400	25.400	19.842	3.6	2.4	66.9	87.4	5 700	7 600	HM88648	HM88610	20.7	52.0	42.5	60.0	69.0	3.6	2.4	0.55	1.10	0.60	0.291	0.185		
36.487	73.025	23.812	24.608	19.050	1.6	0.8	72.2	87.3	5 600	7 400	25880R	25821	15.8	44.0	42.0	65.0	68.0	1.6	0.8	0.29	2.07	1.14	0.294	0.165		
	73.025	23.812	25.654	19.050	3.6	0.8	74.1	92.2	5 400	7 200	2794R	2735X	15.9	49.0	42.5	66.0	69.0	3.6	0.8	0.30	1.98	1.09	0.344	0.134		
36.512	76.200	29.370	28.575	23.020	3.6	0.8	79.5	107	5 400	7 200	HM89449	HM89411	23.9	54.0	44.5	65.0	73.0	3.6	0.8	0.55	1.10	0.60	0.386	0.258		
	79.375	23.812	25.400	19.050	0.8	0.8	81.1	105	5 000	6 700	26877R	26822	16.4	44.0	43.0	71.0	74.0	0.8	0.8	0.32	1.88	1.04	0.404	0.186		
	79.375	29.370	29.771	23.812	0.8	3.2	87.4	105	5 200	6 900	3479	3420	20.8	45.5	44.5	67.0	74.0	0.8	3.2	0.37	1.64	0.90	0.429	0.259		
	85.725	30.162	30.162	23.812	0.8	3.2	108	136	4 800	6 400	3878	3820	22.9	48.0	47.0	73.0	81.0	0.8	3.2	0.40	1.49	0.82	0.605	0.285		
38.000	63.000	17.000	17.000	13.500	SP	SP	43.5	58.2	6 000	8 000	JL69349	JL69310	14.6	49.0	41.0	60.0	56.5	3.5	1.2	0.42	1.44	0.79	0.128	0.070		
38.100	63.500	12.700	11.908	9.525	1.6	0.8	25.5	33.1	5 800	7 700	13889	13830	11.9	45.0	42.5	59.0	60.0	1.6	0.8	0.35	1.73	0.95	0.104	0.045		

[Notes] 1) SP indicates the specially chamfered from.  
2) To the bearings with supplementary code "J" attached at the front of bearing number, tolerances shown in table 7-8 on page A66 are applied.

[Remark] Inch series tapered roller bearings with bore diameter larger than 100 mm are shown in catalog "large size ball & roller bearings".

Single-row tapered roller bearings  
inch series

$d$  (38.100) ~ (40.000) mm

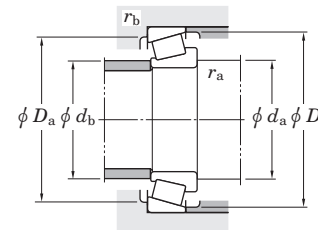
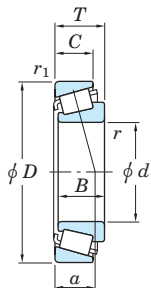

Boundary dimensions (mm)							Basic load ratings (kN)		Limiting speeds (min <sup>-1</sup> )		Inner ring	Outer ring	Load center (mm) a	Mounting dimensions (mm)				Constant e	Axial load factors		(Refer.) Mass (kg)			
d	D	T	B	C	r <sup>1)</sup> min.	r <sub>1</sub> min.	C <sub>r</sub>	C <sub>0r</sub>	Grease lub.	Oil lub.				d <sub>a</sub>	d <sub>b</sub>	D <sub>a</sub>	D <sub>b</sub>		r <sub>a</sub> max.	r <sub>b</sub> max.	Y <sub>1</sub>	Y <sub>0</sub>	Inner ring	Outer ring
<b>38.100</b>	65.088	12.700	11.908	9.525	1.6	0.8	25.5	33.1	5 800	7 700	<b>13889</b>	<b>13836</b>	11.9	45.0	42.5	59.0	61.0	1.6	0.8	0.35	1.73	0.95	0.104	0.046
	65.088	18.034	18.288	13.970	SP	1.2	42.9	56.5	5 800	7 800	<b>LM29748</b>	<b>LM29710</b>	13.8	49.0	42.5	59.0	62.0	3.5	1.2	0.33	1.80	0.99	0.154	0.079
	65.088	19.812	18.288	15.748	2.4	1.2	42.9	56.5	5 800	7 800	<b>LM29749</b>	<b>LM29711</b>	15.6	46.0	42.5	58.0	62.0	2.4	1.2	0.33	1.80	0.99	0.159	0.092
	69.012	19.050	19.050	15.083	2.0	2.4	49.2	62.0	5 600	7 500	<b>13687</b>	<b>13621</b>	16.1	46.5	43.0	61.0	65.0	2.0	2.4	0.40	1.49	0.82	0.191	0.102
	71.438	15.875	16.520	11.908	1.6	1.0	46.1	53.8	5 700	7 600	<b>19150R</b>	<b>19281</b>	14.5	45.0	43.0	63.0	66.0	1.6	1.0	0.44	1.35	0.74	0.167	0.105
	71.996	17.018	16.520	14.288	1.6	1.6	46.1	53.8	5 700	7 600	<b>19150R</b>	<b>19283</b>	15.7	45.0	43.0	63.0	66.0	1.6	1.6	0.44	1.35	0.74	0.167	0.132
	71.996	19.000	20.638	14.237	3.6	1.6	49.7	61.3	5 600	7 400	<b>16150</b>	<b>16282</b>	15.0	49.5	43.0	63.0	67.0	3.6	1.6	0.40	1.49	0.82	0.207	0.121
	72.238	20.638	20.638	15.875	3.6	1.2	49.7	61.3	5 600	7 400	<b>16150</b>	<b>16284</b>	16.6	49.5	43.0	63.0	67.0	3.6	1.2	0.40	1.49	0.82	0.207	0.144
	72.238	23.812	20.638	19.050	3.6	2.4	49.7	61.3	5 600	7 400	<b>16150</b>	<b>16283</b>	19.8	49.5	43.0	61.0	67.0	3.6	2.4	0.40	1.49	0.82	0.207	0.183
	73.025	23.812	25.654	19.050	3.6	0.8	74.1	92.2	5 400	7 200	<b>2788R</b>	<b>2735X</b>	15.9	50.0	43.5	66.0	69.0	3.6	0.8	0.30	1.98	1.09	0.308	0.134
	76.200	23.812	25.654	19.050	3.6	0.8	74.1	92.2	5 400	7 200	<b>2788R</b>	<b>2729</b>	15.9	50.0	43.5	68.0	70.0	3.6	0.8	0.30	1.98	1.09	0.308	0.189
	79.375	29.370	29.771	23.812	3.6	3.2	87.4	105	5 200	6 900	<b>3490</b>	<b>3420</b>	20.8	52.0	45.9	67.0	74.0	3.6	3.2	0.37	1.64	0.90	0.419	0.256
	80.035	21.432	20.940	15.875	1.6	1.6	57.3	65.9	5 300	7 000	<b>28150</b>	<b>28317</b>	16.9	45.5	43.5	69.0	73.0	1.6	1.6	0.40	1.49	0.82	0.285	0.201
	80.035	24.608	23.698	18.512	0.8	1.6	73.2	91.6	5 200	6 900	<b>27880</b>	<b>27820</b>	22.2	48.0	47.0	68.0	75.0	0.8	1.6	0.56	1.07	0.59	0.378	0.208
	80.035	24.608	23.698	18.512	3.6	1.6	73.2	91.6	5 200	6 900	<b>27881</b>	<b>27820</b>	22.2	53.0	47.0	68.0	75.0	3.6	1.6	0.56	1.07	0.59	0.378	0.208
	82.550	29.370	28.575	23.020	0.8	3.2	87.3	117	4 900	6 600	<b>HM801346</b>	<b>HM801310</b>	24.4	51.0	49.0	68.0	78.0	0.8	3.2	0.55	1.10	0.60	0.483	0.282
	82.550	29.370	28.575	23.020	2.4	3.2	87.3	117	4 900	6 600	<b>HM801346X</b>	<b>HM801310</b>	24.4	54.0	49.0	68.0	78.0	2.4	3.2	0.55	1.10	0.60	0.483	0.282
	82.931	23.812	25.400	19.050	0.8	0.8	77.2	100	4 800	6 300	<b>25572</b>	<b>25520</b>	17.5	46.0	46.0	74.0	77.0	0.8	0.8	0.33	1.79	0.99	0.437	0.203
	88.501	26.988	29.083	22.225	3.6	1.6	98.2	112	4 900	6 500	<b>418</b>	<b>414</b>	16.9	51.0	44.5	77.0	80.0	3.6	1.6	0.26	2.28	1.25	0.523	0.325
	90.488	39.688	40.386	33.338	1.6	3.2	132	169	4 500	6 000	<b>4375</b>	<b>4335</b>	25.6	51.0	48.5	77.0	85.0	1.6	3.2	0.28	2.11	1.16	0.841	0.459
101.600	34.925	36.068	26.988	3.6	3.2	131	159	4 000	5 300	<b>525</b>	<b>522</b>	22.2	54.0	48.0	89.0	95.0	3.6	3.2	0.29	2.10	1.16	1.05	0.411	
<b>39.688</b>	73.025	16.667	17.462	12.700	0.8	1.6	45.9	55.8	5 200	6 900	<b>18587</b>	<b>18520</b>	14.5	46.0	46.0	66.0	69.0	0.8	1.6	0.35	1.71	0.94	0.215	0.085
	73.025	23.812	25.654	19.050	3.6	0.8	74.1	92.2	5 400	7 200	<b>2789R</b>	<b>2735X</b>	15.9	52.0	45.0	66.0	69.0	3.6	0.8	0.30	1.98	1.09	0.288	0.134
	80.167	29.370	30.391	23.812	0.8	3.2	91.0	106	5 000	6 700	<b>3386</b>	<b>3320</b>	18.7	46.5	45.5	70.0	75.0	0.8	3.2	0.27	2.20	1.21	0.442	0.217
	84.138	29.370	30.391	23.812	3.6	3.2	91.0	106	5 000	6 700	<b>3382</b>	<b>3328</b>	18.7	52.0	45.5	72.0	76.0	3.6	3.2	0.27	2.20	1.21	0.438	0.312
<b>40.000</b>	76.200	20.638	20.940	15.507	1.6	1.2	57.3	65.9	5 300	7 000	<b>28158</b>	<b>28300</b>	16.5	47.5	45.0	68.0	71.0	1.6	1.2	0.40	1.49	0.82	0.266	0.137
	80.000	21.000	22.403	17.826	3.6	1.2	68.0	74.8	4 900	6 600	<b>344</b>	<b>332</b>	15.1	52.0	45.5	73.0	75.0	3.6	1.2	0.27	2.20	1.21	0.334	0.144

[Note] 1) SP indicates the specially chamfered from.

[Remark] Inch series tapered roller bearings with bore diameter larger than 100 mm are shown in catalog "large size ball & roller bearings".

Single-row tapered roller bearings  
inch series

$d$  (40.000) ~ 42.070 mm

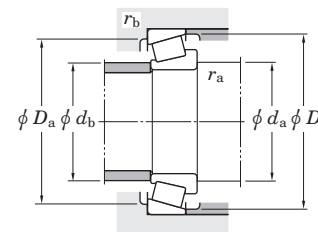
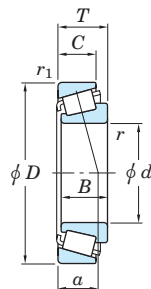

Boundary dimensions (mm)							Basic load ratings (kN)		Limiting speeds (min <sup>-1</sup> )		Bearing No.	Load center (mm) $a$	Mounting dimensions (mm)						Con-stant $e$	Axial load factors		(Refer.) Mass (kg)			
$d$	$D$	$T$	$B$	$C$	$r_{min.}$	$r_{1 min.}$	$C_r$	$C_{0r}$	Grease lub.	Oil lub.			Inner ring	Outer ring	$d_a$	$d_b$	$D_a$	$D_b$		$r_{a max.}$	$r_{b max.}$	$Y_1$	$Y_0$	Inner ring	Outer ring
<b>40.000</b>	80.000	21.000	22.403	17.826	0.8	1.2	68.0	74.8	4 900	6 600	<b>344A</b>	<b>332</b>	15.1	46.0	45.5	73.0	75.0	0.8	1.2	0.27	2.20	1.21	0.334	0.144	
	85.000	20.638	21.692	17.462	0.8	1.2	71.8	81.7	4 600	6 200	<b>350A</b>	<b>354A</b>	15.5	47.5	46.5	77.0	80.0	0.8	1.2	0.31	1.96	1.08	0.416	0.162	
	88.501	26.988	29.083	22.225	3.6	1.6	98.2	112	4 900	6 500	<b>420</b>	<b>414</b>	16.9	52.0	46.0	77.0	80.0	3.6	1.6	0.26	2.28	1.25	0.465	0.325	
	107.950	36.512	36.957	28.575	3.6	3.2	138	172	3 800	5 100	<b>543</b>	<b>532X</b>	23.9	57.0	50.0	94.0	100.0	3.6	3.2	0.30	2.03	1.11	1.17	0.570	
<b>40.483</b>	82.550	29.370	28.575	23.020	3.6	3.2	87.3	117	4 900	6 600	<b>HM801349</b>	<b>HM801310</b>	24.4	58.0	49.0	68.0	78.0	3.6	3.2	0.55	1.10	0.60	0.450	0.282	
<b>41.275</b>	73.025	16.667	17.462	12.700	3.6	1.6	45.9	55.8	5 200	6 900	<b>18590</b>	<b>18520</b>	14.5	53.0	46.0	66.0	69.0	3.6	1.6	0.35	1.71	0.94	0.199	0.085	
	73.431	19.558	19.812	14.732	3.6	0.8	57.8	73.0	5 200	7 000	<b>LM501349</b>	<b>LM501310</b>	16.1	53.0	46.5	67.0	70.0	3.6	0.8	0.40	1.50	0.83	0.227	0.107	
	73.431	21.430	19.812	16.604	3.6	0.8	57.8	73.0	5 200	7 000	<b>LM501349</b>	<b>LM501314</b>	18.0	53.0	46.5	66.0	70.0	3.6	0.8	0.40	1.50	0.83	0.227	0.126	
	73.431	23.012	19.812	18.186	3.6	2.4	57.8	73.0	5 200	7 000	<b>LM501349</b>	<b>LM501311</b>	16.1	53.0	46.5	64.0	70.0	3.6	2.4	0.40	1.50	0.83	0.227	0.140	
	76.200	18.009	17.384	14.288	1.6	1.6	51.6	63.3	5 200	6 900	<b>11162R</b>	<b>11300</b>	17.5	49.0	46.5	67.0	72.0	1.6	1.6	0.49	1.23	0.68	0.221	0.127	
	76.200	22.225	23.020	17.462	3.6	0.8	66.3	83.3	5 200	6 900	<b>24780R</b>	<b>24720</b>	17.4	54.0	47.0	68.0	72.0	3.6	0.8	0.39	1.53	0.84	0.275	0.148	
	80.000	21.000	22.403	17.826	0.8	1.2	68.0	74.8	4 900	6 600	<b>336</b>	<b>332</b>	15.1	47.0	46.0	73.0	75.0	0.8	1.2	0.27	2.20	1.21	0.325	0.144	
	80.000	21.000	22.403	17.826	3.6	1.2	68.0	74.8	4 900	6 600	<b>342</b>	<b>332</b>	15.1	53.0	46.0	73.0	75.0	3.6	1.2	0.27	2.20	1.21	0.317	0.144	
	82.550	26.543	25.654	20.193	3.6	3.2	83.7	105	4 900	6 500	<b>M802048</b>	<b>M802011</b>	23.3	57.0	50.6	70.0	79.0	3.6	3.2	0.55	1.10	0.60	0.403	0.227	
	85.725	30.162	30.162	23.812	3.6	1.2	108	136	4 800	6 400	<b>3877</b>	<b>3821</b>	22.9	57.0	50.3	75.0	81.0	3.6	1.2	0.40	1.49	0.82	0.506	0.324	
	87.312	30.162	30.886	23.812	0.8	3.2	95.8	120	4 600	6 200	<b>3576R</b>	<b>3525</b>	20.5	49.0	48.0	75.0	81.0	0.8	3.2	0.31	1.96	1.08	0.533	0.300	
	88.501	26.988	29.083	22.225	3.6	1.6	98.2	112	4 900	6 500	<b>419</b>	<b>414</b>	16.9	54.0	47.0	77.0	80.0	3.6	1.6	0.26	2.28	1.25	0.441	0.325	
	88.900	20.638	22.225	16.513	3.6	1.2	74.3	87.3	4 400	5 800	<b>365A</b>	<b>362A</b>	16.1	55.0	48.5	81.0	84.0	3.6	1.2	0.32	1.88	1.03	0.458	0.164	
	88.900	30.162	29.370	23.020	0.8	3.2	99.6	125	4 600	6 100	<b>HM803145</b>	<b>HM803110</b>	26.1	54.0	53.0	74.0	85.0	0.8	3.2	0.55	1.10	0.60	0.577	0.318	
	88.900	30.162	29.370	23.020	3.6	3.2	99.6	125	4 600	6 100	<b>HM803146</b>	<b>HM803110</b>	26.1	60.0	53.0	74.0	85.0	3.6	3.2	0.55	1.10	0.60	0.574	0.318	
	90.488	39.688	40.386	33.338	3.6	3.2	132	169	4 500	6 000	<b>4388</b>	<b>4335</b>	25.6	57.0	51.0	77.0	85.0	3.6	3.2	0.28	2.11	1.16	0.775	0.454	
	93.662	31.750	31.750	26.195	0.8	3.2	105	134	4 400	5 800	<b>46162</b>	<b>46368</b>	24.0	52.0	51.0	79.0	87.0	0.8	3.2	0.40	1.49	0.82	0.695	0.403	
	95.250	30.162	29.370	23.020	3.6	3.2	104	140	3 300	4 400	<b>HM804840</b>	<b>HM804810</b>	26.5	61.0	54.0	81.0	91.0	3.6	3.2	0.55	1.10	0.60	0.719	0.351	
	101.600	34.925	36.068	26.988	3.6	3.2	131	159	4 000	5 300	<b>526</b>	<b>522</b>	22.2	57.0	50.0	89.0	95.0	3.6	3.2	0.29	2.10	1.16	1.02	0.411	
	104.775	36.512	36.512	28.575	1.6	3.2	141	195	3 800	5 100	<b>HM807035</b>	<b>HM807010</b>	29.3	60.0	57.0	89.0	100.0	1.6	3.2	0.49	1.23	0.68	1.19	0.497	
	<b>42.070</b>	90.488	39.688	40.386	33.338	3.6	3.2	132	169	4 500	6 000	<b>4395</b>	<b>4335</b>	25.6	58.0	51.0	77.0	85.0	3.6	3.2	0.28	2.11	1.16	0.751	0.459

[Remark] Inch series tapered roller bearings with bore diameter larger than 100 mm are shown in catalog "large size ball & roller bearings".



Single-row tapered roller bearings  
inch series

$d$  42.862 ~ 45.000 mm

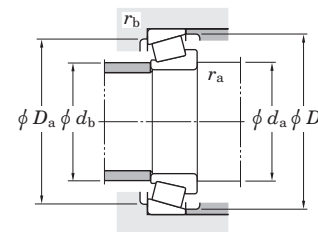
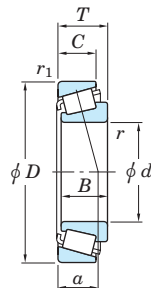

Boundary dimensions (mm)							Basic load ratings (kN)		Limiting speeds (min <sup>-1</sup> )		Bearing No.	Load center (mm)	Mounting dimensions (mm)						Con-stant	Axial load factors		(Refer.) Mass (kg)		
$d$	$D$	$T$	$B$	$C$	$r_{min.}$	$r_{1 min.}$	$C_r$	$C_{0r}$	Grease lub.	Oil lub.			Inner ring	Outer ring	$a$	$d_a$	$d_b$	$D_a$		$D_b$	$r_{a max.}$	$r_{b max.}$	$e$	$Y_1$
<b>42.862</b>	76.992	17.463	17.145	11.908	1.6	1.6	48.4	62.2	5 000	6 600	<b>12168</b>	<b>12303</b>	17.5	51.0	48.5	68.0	73.0	1.6	1.6	0.51	1.19	0.65	0.220	0.097
<b>42.875</b>	79.375	23.812	25.400	19.050	3.6	0.8	81.1	105	5 000	6 700	<b>26884R</b>	<b>26822</b>	16.1	55.0	48.5	71.0	74.0	3.6	0.8	0.32	1.88	1.04	0.314	0.186
	82.931	23.812	25.400	19.050	3.6	0.8	77.2	100	4 800	6 300	<b>25577</b>	<b>25520</b>	17.5	55.0	49.0	74.0	77.0	3.6	0.8	0.33	1.79	0.99	0.382	0.200
<b>44.450</b>	73.025	18.258	18.258	15.083	1.6	1.6	47.2	65.5	5 100	6 800	<b>L102849</b>	<b>L102810</b>	14.6	51.0	49.0	66.0	69.0	1.6	1.6	0.32	1.88	1.04	0.183	0.102
	76.992	17.463	17.145	11.908	1.6	1.6	48.4	62.2	5 000	6 600	<b>12175</b>	<b>12303</b>	17.5	52.0	49.5	68.0	73.0	1.6	1.6	0.51	1.19	0.65	0.206	0.097
	79.375	17.462	17.462	13.495	2.8	1.6	47.1	59.1	4 800	6 400	<b>18685</b>	<b>18620</b>	16.0	54.0	49.5	71.0	74.0	2.8	1.6	0.37	1.60	0.88	0.214	0.126
	82.931	23.812	25.400	19.050	5.2	0.8	77.2	100	4 800	6 300	<b>25582</b>	<b>25520</b>	17.5	59.0	51.0	74.0	77.0	5.2	0.8	0.33	1.79	0.99	0.361	0.200
	84.138	30.162	30.886	23.812	3.6	3.2	95.8	120	4 600	6 200	<b>3578R</b>	<b>3520</b>	20.5	57.0	51.0	74.0	79.5	3.6	3.2	0.31	1.96	1.08	0.479	0.221
	85.000	20.638	21.692	17.462	2.4	1.2	71.8	81.7	4 600	6 200	<b>355</b>	<b>354A</b>	15.5	54.0	50.0	77.0	80.0	2.4	1.2	0.31	1.96	1.08	0.344	0.160
	85.000	20.638	21.692	17.462	0.8	1.2	71.8	81.7	4 600	6 200	<b>355A</b>	<b>354A</b>	15.5	51.0	50.0	77.0	80.0	0.8	1.2	0.31	1.96	1.08	0.344	0.160
	88.900	30.162	29.370	23.020	3.6	3.2	99.6	125	4 600	6 100	<b>HM803149</b>	<b>HM803110</b>	26.1	62.0	53.4	74.0	85.0	3.6	3.2	0.55	1.10	0.60	0.525	0.318
	93.662	31.750	31.750	25.400	3.6	3.2	105	123	4 400	5 900	<b>49175</b>	<b>49368</b>	22.9	59.0	53.0	82.0	87.0	3.6	3.2	0.36	1.67	0.92	0.645	0.371
	93.662	31.750	31.750	26.195	0.8	3.2	105	134	4 400	5 800	<b>46175</b>	<b>46368</b>	24.0	55.0	54.0	79.0	87.0	0.8	3.2	0.40	1.49	0.82	0.609	0.403
	93.662	31.750	31.750	26.195	3.6	3.2	105	134	4 400	5 800	<b>46176</b>	<b>46368</b>	24.0	60.0	54.0	79.0	87.0	3.6	3.2	0.40	1.49	0.82	0.609	0.403
	95.250	27.783	28.575	22.225	0.8	2.4	108	141	4 100	5 400	<b>33885</b>	<b>33821</b>	20.4	53.0	53.0	85.0	90.0	0.8	2.4	0.33	1.82	1.00	0.714	0.264
	95.250	27.783	29.901	22.225	3.6	0.8	103	122	4 500	5 900	<b>438</b>	<b>432A</b>	18.4	57.0	51.0	84.0	87.0	3.6	0.8	0.28	2.11	1.16	0.555	0.375
	95.250	30.162	29.370	23.020	0.8	2.4	104	140	3 300	4 400	<b>HM804842</b>	<b>HM804810</b>	26.5	57.0	57.0	81.0	91.0	0.8	2.4	0.55	1.10	0.60	0.673	0.351
	95.250	30.162	29.370	23.020	3.6	2.4	104	140	3 300	4 400	<b>HM804843</b>	<b>HM804810</b>	26.5	63.0	57.0	81.0	91.0	3.6	2.4	0.55	1.10	0.60	0.670	0.351
	98.425	30.162	31.750	25.400	0.8	3.2	114	143	3 900	5 200	<b>49576</b>	<b>49520</b>	24.1	55.0	54.0	88.0	96.0	0.8	3.2	0.40	1.50	0.82	0.856	0.384
	101.600	34.925	36.068	26.988	3.6	3.2	131	159	4 000	5 300	<b>527</b>	<b>522</b>	22.2	59.0	53.0	89.0	95.0	3.6	3.2	0.29	2.10	1.16	0.939	0.411
	104.775	36.512	36.512	28.575	3.6	3.2	141	195	3 800	5 100	<b>HM807040</b>	<b>HM807010</b>	29.3	66.0	59.0	89.0	100.0	3.6	3.2	0.49	1.23	0.68	1.13	0.497
	111.125	38.100	36.957	30.162	3.6	3.2	138	172	3 800	5 100	<b>535</b>	<b>532A</b>	23.9	60.0	54.0	95.0	100.0	3.6	3.2	0.30	2.03	1.11	1.09	0.746
	120.650	41.275	41.275	31.750	3.6	3.2	174	217	3 500	4 600	<b>615</b>	<b>612</b>	27.3	62.0	56.0	105.0	110.0	3.6	3.2	0.31	1.91	1.05	1.48	0.853
<b>44.983</b>	93.264	30.162	30.302	23.812	3.6	3.2	103	137	4 200	5 500	<b>3776</b>	<b>3720</b>	22.2	59.0	53.0	82.0	88.0	3.6	3.2	0.34	1.77	0.97	0.650	0.288
<b>45.000</b>	85.000	20.638	21.692	17.462	1.6	1.2	71.8	81.7	4 600	6 200	<b>358</b>	<b>354A</b>	15.5	52.5	50.0	77.0	80.0	1.6	1.2	0.31	1.96	1.08	0.338	0.162

[Remark] Inch series tapered roller bearings with bore diameter larger than 100 mm are shown in catalog "large size ball & roller bearings".

Single-row tapered roller bearings  
inch series

d 45.242 ~ 49.212 mm

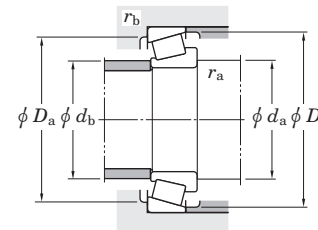
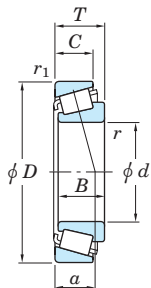

Boundary dimensions (mm)							Basic load ratings (kN)		Limiting speeds (min <sup>-1</sup> )		Bearing No.	Load center (mm) a	Mounting dimensions (mm)						Con- stant e	Axial load factors		(Refer.) Mass (kg)		
d	D	T	B	C	r <sub>min.</sub>	r <sub>1 min.</sub>	C <sub>r</sub>	C <sub>0r</sub>	Grease lub.	Oil lub.			Inner ring	Outer ring	d <sub>a</sub>	d <sub>b</sub>	D <sub>a</sub>	D <sub>b</sub>		r <sub>a max.</sub>	r <sub>b max.</sub>	Y <sub>1</sub>	Y <sub>0</sub>	Inner ring
<b>45.242</b>	73.431	19.558	19.812	15.748	3.6	0.8	55.6	78.1	5 100	6 700	<b>LM102949</b>	<b>LM102910</b>	14.7	56.0	50.0	68.0	70.0	3.6	0.8	0.31	1.97	1.08	0.209	0.100
	77.788	19.842	19.842	15.080	3.6	0.8	57.1	73.5	4 900	6 500	<b>LM603049</b>	<b>LM603011</b>	17.5	57.0	50.0	71.0	74.0	3.6	0.8	0.43	1.41	0.77	0.243	0.120
	77.788	21.430	19.842	16.667	3.6	0.8	57.1	73.5	4 900	6 500	<b>LM603049</b>	<b>LM603012</b>	19.1	57.0	50.0	71.0	74.0	3.6	0.8	0.43	1.41	0.77	0.243	0.138
	79.974	19.842	19.842	15.080	3.6	0.8	57.1	73.5	4 900	6 500	<b>LM603049</b>	<b>LM603014</b>	17.5	57.0	50.0	71.0	74.0	3.6	0.8	0.43	1.41	0.77	0.243	0.152
<b>45.618</b>	85.000	23.812	25.400	19.050	3.6	2.4	77.2	100	4 800	6 300	<b>25590</b>	<b>25526</b>	17.5	58.0	51.0	74.0	78.0	3.6	2.4	0.33	1.79	0.99	0.344	0.241
<b>45.987</b>	74.976	18.000	18.000	14.000	2.4	1.6	52.6	74.6	5 000	6 600	<b>LM503349R</b>	<b>LM503310</b>	16.0	53.0	51.0	67.0	72.0	2.4	1.6	0.40	1.49	0.82	0.207	0.095
<b>46.038</b>	79.375	17.462	17.462	13.495	2.8	1.6	47.1	59.1	4 800	6 400	<b>18690</b>	<b>18620</b>	16.0	56.0	51.0	71.0	74.0	2.8	1.6	0.37	1.60	0.88	0.208	0.123
	85.000	20.638	21.692	17.462	3.6	1.2	71.8	81.7	4 600	6 200	<b>359A</b>	<b>354A</b>	15.5	57.0	51.0	77.0	80.0	3.6	1.2	0.31	1.96	1.08	0.323	0.160
	85.000	20.638	21.692	17.462	2.4	1.2	71.8	81.7	4 600	6 200	<b>359S</b>	<b>354A</b>	15.5	55.0	51.0	77.0	80.0	2.4	1.2	0.31	1.96	1.08	0.323	0.160
	85.000	25.400	25.608	20.638	3.6	1.2	80.0	106	4 600	6 100	<b>2984</b>	<b>2924</b>	18.9	58.0	52.0	76.0	80.0	3.6	1.2	0.35	1.73	0.95	0.389	0.220
<b>47.625</b>	88.900	20.638	22.225	16.513	3.6	1.2	74.3	87.3	4 400	5 800	<b>369A</b>	<b>362A</b>	16.1	60.0	53.0	81.0	84.0	3.6	1.2	0.32	1.88	1.03	0.373	0.164
	88.900	25.400	25.400	19.050	3.6	3.2	87.1	112	4 400	5 900	<b>M804049</b>	<b>M804010</b>	23.6	62.0	55.0	76.0	85.0	3.6	3.2	0.55	1.10	0.60	0.450	0.216
	95.250	30.162	29.370	23.020	3.6	3.2	104	140	3 300	4 400	<b>HM804846</b>	<b>HM804810</b>	26.5	64.0	57.0	81.0	91.0	3.6	3.2	0.55	1.10	0.60	0.617	0.351
	96.838	21.000	21.946	15.875	0.8	0.8	80.4	101	3 900	5 200	<b>386A</b>	<b>382A</b>	17.4	56.0	55.0	89.0	92.0	0.8	0.8	0.35	1.69	0.93	0.563	0.177
	101.600	34.925	36.068	26.988	3.6	3.2	131	159	4 000	5 300	<b>528</b>	<b>522</b>	22.2	62.0	55.0	89.0	95.0	3.6	3.2	0.29	2.10	1.16	0.871	0.411
	104.775	30.162	29.317	24.605	4.8	3.2	109	144	3 700	4 900	<b>463</b>	<b>453X</b>	23.6	65.0	56.0	92.0	98.0	4.8	3.2	0.34	1.79	0.98	0.838	0.372
	104.775	30.162	29.317	24.605	0.8	3.2	109	144	3 700	4 900	<b>467</b>	<b>453X</b>	23.6	57.0	56.0	92.0	98.0	0.8	3.2	0.34	1.79	0.98	0.844	0.372
	104.775	30.162	30.958	23.812	3.6	3.2	126	165	3 700	4 900	<b>45282</b>	<b>45220</b>	22.2	64.0	59.0	93.0	99.0	3.6	3.2	0.33	1.80	0.99	0.940	0.345
<b>48.412</b>	95.250	30.162	29.370	23.020	2.4	3.2	104	140	3 300	4 400	<b>HM804848</b>	<b>HM804810</b>	26.5	63.0	57.5	81.0	91.0	2.4	3.2	0.55	1.10	0.60	0.606	0.351
	95.250	30.162	29.370	23.020	3.6	3.2	104	140	3 300	4 400	<b>HM804849</b>	<b>HM804810</b>	26.5	66.0	57.5	81.0	91.0	3.6	3.2	0.55	1.10	0.60	0.604	0.351
<b>49.212</b>	88.900	20.638	22.225	16.513	0.8	1.2	74.3	87.3	4 400	5 800	<b>365S</b>	<b>362A</b>	16.1	55.0	54.0	81.0	84.0	0.8	1.2	0.32	1.88	1.03	0.366	0.164
	104.775	36.512	36.512	28.575	3.6	3.2	141	195	3 800	5 100	<b>HM807044</b>	<b>HM807010</b>	29.3	69.0	63.0	89.0	100.0	3.6	3.2	0.49	1.23	0.68	1.03	0.497
	114.300	44.450	44.450	34.925	3.6	3.2	189	230	3 800	5 000	<b>65390</b>	<b>65320</b>	31.7	70.0	60.0	97.0	107.0	3.6	3.2	0.43	1.40	0.77	1.28	0.894
	114.300	44.450	44.450	36.068	3.6	3.2	212	263	3 700	5 000	<b>HH506348</b>	<b>HH506310</b>	30.6	71.0	61.0	97.0	107.0	3.6	3.2	0.40	1.49	0.82	1.49	0.834

[Remark] Inch series tapered roller bearings with bore diameter larger than 100 mm are shown in catalog "large size ball & roller bearings".

Single-row tapered roller bearings  
inch series

d 49.987 ~ (50.800) mm

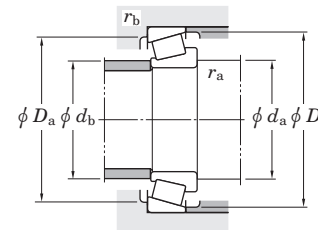
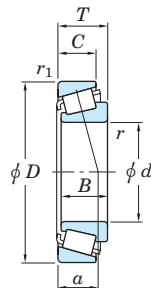

Boundary dimensions (mm)							Basic load ratings (kN)		Limiting speeds (min <sup>-1</sup> )		Bearing No. <sup>1)</sup>	Load center (mm) a	Mounting dimensions (mm)						Con-stant e	Axial load factors		(Refer.) Mass (kg)		
d	D	T	B	C	r min.	r <sub>1</sub> min.	C <sub>r</sub>	C <sub>0r</sub>	Grease lub.	Oil lub.			Inner ring	Outer ring	d <sub>a</sub>	d <sub>b</sub>	D <sub>a</sub>	D <sub>b</sub>		r <sub>a</sub> max.	r <sub>b</sub> max.	Y <sub>1</sub>	Y <sub>0</sub>	Inner ring
<b>49.987</b>	92.075	24.608	25.400	19.845	2.4	0.8	84.8	119	4 200	5 600	<b>28579R</b>	<b>28521</b>	19.9	60.0	56.0	83.0	87.0	2.4	0.8	0.38	1.59	0.87	0.463	0.247
<b>50.000</b>	82.000	21.501	21.501	17.000	3.0	0.5	71.7	97.9	4 500	6 000	<b>JLM104948</b>	<b>JLM104910</b>	16.2	60.0	55.0	76.0	78.0	3.0	0.5	0.31	1.97	1.08	0.304	0.128
	88.900	20.638	22.225	16.513	2.0	1.2	74.3	87.3	4 400	5 800	<b>365</b>	<b>362A</b>	16.1	58.0	55.0	81.0	84.0	2.0	1.2	0.32	1.88	1.03	0.346	0.164
	88.900	20.638	22.225	16.513	2.4	1.2	74.3	87.3	4 400	5 800	<b>366</b>	<b>362A</b>	16.1	59.0	55.0	81.0	84.0	2.4	1.2	0.32	1.88	1.03	0.351	0.166
	90.000	28.000	28.000	23.000	3.0	2.5	105	138	4 300	5 800	<b>JM205149</b>	<b>JM205110</b>	20.2	62.0	57.0	80.0	85.0	3.0	2.5	0.33	1.82	1.00	0.508	0.243
	105.000	37.000	36.000	29.000	3.0	2.8	149	205	3 800	5 100	<b>JHM807045</b>	<b>JHM807012</b>	29.4	69.0	63.0	90.0	100.0	3.0	2.8	0.49	1.23	0.68	1.01	0.523
	110.000	22.000	21.996	18.824	0.8	1.2	86.4	116	3 400	4 500	<b>396</b>	<b>394A</b>	21.3	61.0	60.0	101.0	105.0	0.8	1.2	0.40	1.49	0.82	0.777	0.264
<b>50.800</b>	80.962	18.258	18.258	14.288	1.6	1.6	54.0	81.1	4 600	6 100	<b>L305649R</b>	<b>L305610</b>	16.0	58.0	56.0	73.0	77.0	1.6	1.6	0.35	1.69	0.93	0.228	0.119
	82.550	21.590	22.225	16.510	3.6	1.2	61.2	84.3	4 500	6 000	<b>LM104949</b>	<b>LM104911</b>	16.4	62.0	55.0	75.0	78.0	3.6	1.2	0.31	1.97	1.08	0.287	0.131
	85.725	19.050	18.263	12.700	1.6	1.6	50.7	66.4	4 400	5 900	<b>18200</b>	<b>18337</b>	22.7	59.0	56.0	76.0	81.0	1.6	1.6	0.57	1.06	0.58	0.268	0.134
	88.900	17.462	17.462	13.495	3.6	1.2	49.7	65.5	4 400	5 900	<b>18790</b>	<b>18724</b>	17.4	62.0	56.0	78.0	82.0	3.6	1.2	0.41	1.48	0.81	0.226	0.190
	88.900	20.638	22.225	16.513	1.6	1.2	74.3	87.3	4 400	5 800	<b>368</b>	<b>362A</b>	16.1	58.0	56.0	81.0	84.0	1.6	1.2	0.32	1.88	1.03	0.333	0.164
	88.900	20.638	22.225	16.513	3.6	1.2	74.3	87.3	4 400	5 800	<b>368A</b>	<b>362A</b>	16.1	62.0	56.0	81.0	84.0	3.6	1.2	0.32	1.88	1.03	0.331	0.164
	88.900	20.638	22.225	16.513	5.2	1.2	74.3	87.3	4 400	5 800	<b>370A</b>	<b>362A</b>	16.1	65.0	56.0	81.0	84.0	5.2	1.2	0.32	1.88	1.03	0.326	0.164
	92.075	24.608	25.400	19.845	3.6	0.8	84.8	119	4 200	5 600	<b>28580R</b>	<b>28521</b>	19.9	63.0	57.0	83.0	87.0	3.6	0.8	0.38	1.59	0.87	0.453	0.247
	93.264	20.638	22.225	15.083	2.4	1.2	84.4	98.5	4 200	5 600	<b>375</b>	<b>374</b>	17.1	60.0	57.0	85.0	88.0	2.4	1.2	0.34	1.77	0.97	0.416	0.174
	93.264	30.162	30.302	23.812	3.6	3.2	103	137	4 200	5 500	<b>3780</b>	<b>3720</b>	22.2	64.0	58.0	82.0	88.0	3.6	3.2	0.34	1.77	0.97	0.547	0.288
	93.264	30.162	30.302	23.812	3.6	0.8	103	137	4 200	5 500	<b>3780</b>	<b>3730</b>	22.2	64.0	58.0	84.0	88.0	3.6	0.8	0.34	1.77	0.97	0.547	0.293
	95.250	27.783	28.575	22.225	3.6	0.8	108	141	4 100	5 400	<b>33889</b>	<b>33822</b>	20.4	64.0	58.0	86.0	90.0	3.6	0.8	0.33	1.82	1.00	0.604	0.267
	96.838	21.000	21.946	15.875	0.8	0.8	80.4	101	3 900	5 200	<b>385AX</b>	<b>382A</b>	17.4	59.0	58.0	89.0	92.0	0.8	0.8	0.35	1.69	0.93	0.521	0.177
	97.630	24.608	24.608	19.446	3.6	0.8	89.6	131	3 900	5 200	<b>28678</b>	<b>28622</b>	21.2	65.0	58.0	88.0	92.0	3.6	0.8	0.40	1.49	0.82	0.569	0.267
	98.425	30.162	30.302	23.812	3.6	3.2	103	137	4 200	5 500	<b>3780</b>	<b>3732</b>	22.2	64.0	58.0	84.0	90.0	3.6	3.2	0.34	1.77	0.97	0.547	0.433
	101.600	31.750	31.750	25.400	3.6	3.2	114	143	3 900	5 200	<b>49585</b>	<b>49520</b>	24.1	66.0	59.0	88.0	96.0	3.6	3.2	0.40	1.50	0.82	0.736	0.384
	101.600	34.925	36.068	26.988	0.8	3.2	131	159	4 000	5 300	<b>529</b>	<b>522</b>	22.2	59.0	58.0	89.0	95.0	0.8	3.2	0.29	2.10	1.16	0.806	0.411
	101.600	34.925	36.068	26.988	3.6	3.2	131	159	4 000	5 300	<b>529X</b>	<b>522</b>	22.2	65.0	58.0	89.0	95.0	3.6	3.2	0.29	2.10	1.16	0.802	0.411
	104.775	30.162	30.958	23.812	6.4	3.2	126	165	3 700	4 900	<b>45284</b>	<b>45220</b>	22.2	71.0	59.0	93.0	99.0	6.4	3.2	0.33	1.80	0.99	0.873	0.345
	104.775	36.512	36.512	28.575	3.6	3.2	148	187	3 900	5 100	<b>59200</b>	<b>59412</b>	26.9	68.0	61.0	92.0	99.0	3.6	3.2	0.40	1.49	0.82	0.767	0.623

[Note] 1) To the bearings with supplementary code "J" attached at the front of bearing number, tolerances shown in table 7-8 on page A66 are applied.

[Remark] Inch series tapered roller bearings with bore diameter larger than 100 mm are shown in catalog "large size ball & roller bearings".

Single-row tapered roller bearings  
inch series

$d$  (50.800) ~ (55.000) mm

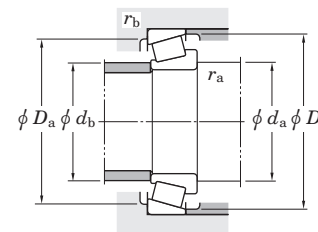
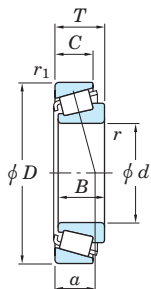

Boundary dimensions (mm)							Basic load ratings (kN)		Limiting speeds (min <sup>-1</sup> )		Bearing No. <sup>1)</sup>	Load center (mm) $a$	Mounting dimensions (mm)						Con-stant $e$	Axial load factors		(Refer.) Mass (kg)		
$d$	$D$	$T$	$B$	$C$	$r_{min.}$	$r_{1min.}$	$C_r$	$C_{0r}$	Grease lub.	Oil lub.			Inner ring	Outer ring	$d_a$	$d_b$	$D_a$	$D_b$		$r_{a max.}$	$r_{b max.}$	$Y_1$	$Y_0$	Inner ring
50.800	104.775	36.512	36.512	28.575	3.6	3.2	141	195	3 800	5 100	HM807046 4580 537 39575 619 65200	HM807010 4535 532X 39520 612 65500	29.3	70.0	63.0	89.0	100.0	3.6	3.2	0.49	1.23	0.68	0.995	0.497
	104.775	39.688	40.157	33.338	3.6	3.2	151	211	3 800	5 100			27.3	67.0	61.0	90.0	99.0	3.6	3.2	0.34	1.79	0.98	1.06	0.576
	107.950	36.512	36.957	28.575	3.6	3.2	138	172	3 800	5 100			23.9	65.0	59.0	94.0	100.0	3.6	3.2	0.30	2.03	1.11	0.969	0.569
	112.712	30.162	30.162	23.812	3.6	3.2	147	207	3 300	4 500			23.3	68.0	61.0	101.0	107.0	3.6	3.2	0.34	1.77	0.97	1.13	0.355
	120.650	41.275	41.275	31.750	3.6	3.2	174	217	3 500	4 600			27.3	67.0	61.0	105.0	110.0	3.6	3.2	0.31	1.91	1.05	1.44	0.853
	127.000	44.450	44.450	34.925	3.6	3.2	208	269	3 300	4 400			35.2	75.0	69.0	107.0	119.0	3.6	3.2	0.49	1.23	0.68	1.86	1.03
	51.592	88.900	20.638	22.225	16.513	2.0	1.2	74.3	87.3	4 400			5 800	368S	362A	16.1	59.0	56.0	81.0	84.0	2.0	1.2	0.32	1.88
52.388	92.075	24.608	25.400	19.845	3.6	0.8	84.8	119	4 200	5 600	28584R 468	28521 453X	19.9	65.0	58.0	83.0	87.0	3.6	0.8	0.38	1.59	0.87	0.435	0.247
	104.775	30.162	29.317	24.605	1.6	3.2	109	144	3 700	4 900			23.6	62.0	60.0	92.0	98.0	1.6	3.2	0.34	1.79	0.98	0.748	0.372
53.975	88.900	19.050	19.050	13.492	2.4	2.0	62.9	86.8	4 200	5 600	LM806649 33895 456 HM807049 4595 539 539A 66212R 621 66584 5578R 557S 65212	LM806610 33822 453X HM807010 4535 532X 532X 66462 612 66520 5535 552A 65500	21.5	63.0	60.0	80.0	85.0	2.4	2.0	0.55	1.10	0.60	0.312	0.135
	95.250	27.783	28.575	22.225	1.6	0.8	108	141	4 100	5 400			20.4	63.0	60.0	86.0	90.0	1.6	0.8	0.33	1.82	1.00	0.550	0.267
	104.775	30.162	29.317	24.605	3.6	3.2	109	144	3 700	4 900			23.6	68.0	61.0	92.0	98.0	3.6	3.2	0.34	1.79	0.98	0.728	0.372
	104.775	36.512	36.512	28.575	3.6	3.2	141	195	3 800	5 100			29.3	73.0	63.0	89.0	100.0	3.6	3.2	0.49	1.23	0.68	0.921	0.497
	104.775	39.688	40.157	33.338	3.6	3.2	151	211	3 800	5 100			27.3	70.0	63.0	90.0	99.0	3.6	3.2	0.34	1.79	0.98	0.981	0.576
	107.950	36.512	36.957	28.575	3.6	3.2	138	172	3 800	5 100			23.9	68.0	61.0	94.0	100.0	3.6	3.2	0.30	2.03	1.11	0.894	0.569
	107.950	36.512	36.957	28.575	5.6	3.2	138	172	3 800	5 100			23.9	72.0	61.0	94.0	100.0	5.6	3.2	0.30	2.03	1.11	0.861	0.569
	117.475	33.338	31.750	23.812	3.6	3.2	129	152	3 500	4 600			33.2	73.0	67.0	100.0	111.0	3.6	3.2	0.63	0.96	0.53	1.03	0.552
	120.650	41.275	41.275	31.750	3.6	3.2	174	217	3 500	4 600			27.3	70.0	63.0	105.0	110.0	3.6	3.2	0.31	1.91	1.05	1.36	0.853
	122.238	33.338	31.750	23.812	3.6	3.2	128	153	3 300	4 300			35.4	75.0	68.0	105.0	116.0	3.6	3.2	0.67	0.90	0.50	1.25	0.551
	122.238	43.658	43.764	36.512	3.6	3.2	221	318	3 200	4 300			31.1	73.0	67.0	106.0	116.0	3.6	3.2	0.36	1.67	0.92	1.84	0.807
	123.825	38.100	36.678	30.162	3.6	3.2	162	223	3 200	4 200			28.7	71.0	65.0	109.0	116.0	3.6	3.2	0.35	1.73	0.95	1.47	0.756
	127.000	44.450	44.450	34.925	3.6	3.2	208	269	3 300	4 400			35.2	77.0	71.0	107.0	119.0	3.6	3.2	0.49	1.23	0.68	1.78	1.02
	54.988	104.775	30.162	29.317	24.605	2.4	3.2	109	144	3 700			4 900	466	453X	23.6	67.0	61.0	92.0	98.0	2.4	3.2	0.34	1.79
54.991	135.755	53.975	56.007	44.450	3.6	3.2	266	357	3 000	4 000	6381	6320	34.8	76.0	70.0	117.0	126.0	3.6	3.2	0.32	1.85	1.02	2.75	1.37
55.000	90.000	23.000	23.000	18.500	1.6	0.5	81.4	115	4 200	5 500	JLM506849	JLM506810	20.1	63.0	61.0	82.0	86.0	1.6	0.5	0.40	1.49	0.82	0.370	0.183

[Note] 1) To the bearings with supplementary code "J" attached at the front of bearing number, tolerances shown in table 7-8 on page A66 are applied.

[Remark] Inch series tapered roller bearings with bore diameter larger than 100 mm are shown in catalog "large size ball & roller bearings".

Single-row tapered roller bearings  
inch series

$d$  (55.000) ~ (60.000) mm

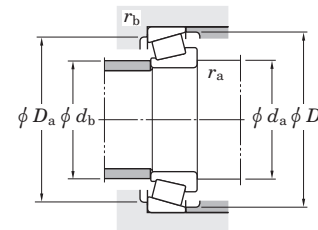
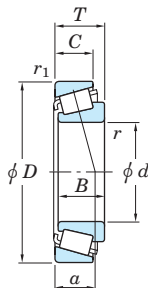

Boundary dimensions (mm)							Basic load ratings (kN)		Limiting speeds (min <sup>-1</sup> )		Bearing No. <sup>1)</sup>	Load center (mm) a	Mounting dimensions (mm)						Constant e	Axial load factors		(Refer.) Mass (kg)		
d	D	T	B	C	r min.	r <sub>1</sub> min.	C <sub>r</sub>	C <sub>0r</sub>	Grease lub.	Oil lub.			Inner ring	Outer ring	d <sub>a</sub>	d <sub>b</sub>	D <sub>a</sub>	D <sub>b</sub>		r <sub>a</sub> max.	r <sub>b</sub> max.	Y <sub>1</sub>	Y <sub>0</sub>	Inner ring
55.000	95.000	29.000	29.000	23.500	1.6	2.8	110	150	4 000	5 300	JM207049 385 385X JH307749	JM207010 382A 382A JH307710	21.3	64.0	62.0	85.0	91.0	1.6	2.8	0.33	1.79	0.99	0.567	0.256
	96.838	21.000	21.946	15.875	2.4	0.8	80.4	101	3 900	5 200			17.4	65.0	61.0	89.0	92.0	2.4	0.8	0.35	1.69	0.93	0.461	0.177
	96.838	21.000	21.946	15.875	3.6	0.8	80.4	101	3 900	5 200			17.4	67.0	61.0	89.0	92.0	3.6	0.8	0.35	1.69	0.93	0.459	0.177
	110.000	39.000	39.000	32.000	3.0	2.5	176	224	3 600	4 900			26.8	71.0	64.0	97.0	104.0	3.0	2.5	0.35	1.73	0.95	1.16	0.560
55.562	97.630	24.608	24.608	19.446	3.6	0.8	89.6	131	3 900	5 200	28680 5566R HM813840	28622 5535 HM813810	21.2	68.0	62.0	88.0	92.0	3.6	0.8	0.40	1.49	0.82	0.492	0.267
	122.238	43.658	43.764	36.512	1.2	3.2	221	318	3 200	4 300			31.1	70.0	68.0	106.0	116.0	1.2	3.2	0.36	1.67	0.92	1.82	0.807
	127.000	36.512	36.512	26.988	3.6	3.2	166	235	3 000	4 000			32.9	76.0	70.0	111.0	121.0	3.6	3.2	0.50	1.20	0.66	1.72	0.606
55.575	96.838	21.000	21.946	15.875	2.4	0.8	80.4	101	3 900	5 200	389	382A	17.4	65.0	61.0	89.0	92.0	2.4	0.8	0.35	1.69	0.93	0.452	0.177
57.150	96.838	21.000	21.946	15.875	2.4	0.8	80.4	101	3 900	5 200	387 387A 387AS 387S 387 462 469 45291 3979 39580 39581 33225 623 65225	382A 382A 382A 382A 382 453X 453X 45221 3920 39520 39520 33462 612 65500	17.4	66.0	62.0	89.0	92.0	2.4	0.8	0.35	1.69	0.93	0.428	0.177
	96.838	21.000	21.946	15.875	3.6	0.8	80.4	101	3 900	5 200			17.4	69.0	62.0	89.0	92.0	3.6	0.8	0.35	1.69	0.93	0.426	0.177
	96.838	21.000	21.946	15.875	5.2	0.8	80.4	101	3 900	5 200			17.4	72.0	62.0	89.0	92.0	5.2	0.8	0.35	1.69	0.93	0.422	0.177
	96.838	21.000	21.946	15.875	0.8	0.8	80.4	101	3 900	5 200			17.4	63.0	62.0	89.0	92.0	0.8	0.8	0.35	1.69	0.93	0.431	0.177
	98.425	21.000	21.946	17.826	2.4	0.8	80.4	101	3 900	5 200			17.4	66.0	62.0	89.0	92.0	2.4	0.8	0.35	1.69	0.93	0.428	0.223
	104.775	30.162	29.317	24.605	2.4	3.2	109	144	3 700	4 900			23.6	67.0	63.0	92.0	98.0	2.4	3.2	0.34	1.79	0.98	0.685	0.372
	104.775	30.162	29.317	24.605	3.6	3.2	109	144	3 700	4 900			23.6	70.0	63.0	92.0	98.0	3.6	3.2	0.34	1.79	0.98	0.682	0.372
	104.775	30.162	30.958	23.812	6.4	0.8	126	165	3 700	4 900			22.2	76.0	65.0	95.0	99.0	6.4	0.8	0.33	1.80	0.99	0.742	0.350
	112.712	30.162	30.048	23.812	3.6	3.2	111	164	3 400	4 500			25.9	72.0	66.0	99.0	106.0	3.6	3.2	0.40	1.49	0.82	0.916	0.448
	112.712	30.162	30.162	23.812	3.6	3.2	147	207	3 300	4 500			23.3	72.0	66.0	101.0	107.0	3.6	3.2	0.34	1.77	0.97	1.05	0.355
	112.712	30.162	30.162	23.812	7.9	3.2	147	207	3 300	4 500			23.3	81.0	66.0	101.0	107.0	7.9	3.2	0.34	1.77	0.97	1.03	0.355
	117.475	30.162	30.162	23.812	3.6	3.2	118	179	3 200	4 200			27.8	74.0	68.0	104.0	112.0	3.6	3.2	0.44	1.38	0.76	1.13	0.442
	120.650	41.275	41.275	31.750	3.6	3.2	174	217	3 500	4 600			27.3	72.0	66.0	105.0	110.0	3.6	3.2	0.31	1.91	1.05	1.27	0.853
127.000	44.450	44.450	34.925	3.6	3.2	208	269	3 300	4 400	35.2	80.0	71.0	107.0	119.0	3.6	3.2	0.49	1.23	0.68	1.69	1.02			
57.531	96.838	21.000	21.946	15.875	3.6	0.8	80.4	101	3 900	5 200	388A	382A	17.4	69.0	63.0	89.0	92.0	3.6	0.8	0.35	1.69	0.93	0.420	0.177
59.972	122.238	33.338	31.750	23.812	0.8	3.2	128	153	3 300	4 300	66589	66520	35.4	74.0	73.0	105.0	116.0	0.8	3.2	0.67	0.90	0.50	1.11	0.551
60.000	95.000	24.000	24.000	19.000	5.0	2.5	86.1	125	3 900	5 200	JLM508748	JLM508710	21.2	75.0	66.0	85.0	91.0	5.0	2.5	0.40	1.49	0.82	0.402	0.196

[Note] 1) To the bearings with supplementary code "J" attached at the front of bearing number, tolerances shown in table 7-8 on page A66 are applied.

[Remark] Inch series tapered roller bearings with bore diameter larger than 100 mm are shown in catalog "large size ball & roller bearings".

Single-row tapered roller bearings  
inch series

$d$  (60.000) ~ (65.000) mm

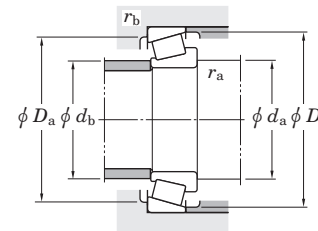
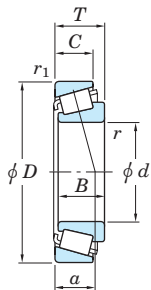

Boundary dimensions (mm)							Basic load ratings (kN)		Limiting speeds (min <sup>-1</sup> )		Bearing No. <sup>1)</sup>	Load center (mm) a	Mounting dimensions (mm)						Constant e	Axial load factors		(Refer.) Mass (kg)		
d	D	T	B	C	r min.	r1 min.	Cr	C0r	Grease lub.	Oil lub.			Inner ring	Outer ring	da	db	Da	Db		ra max.	rb max.	Y1	Y0	Inner ring
<b>60.000</b>	107.950	25.400	25.400	19.050	3.6	3.2	92.8	143	3 400	4 500	<b>29580</b> <b>397</b>	<b>29520</b> <b>394A</b>	24.7	74.0	68.0	96.0	103.0	3.6	3.2	0.46	1.31	0.72	0.713	0.277
	110.000	22.000	21.996	18.824	0.8	1.2	86.4	116	3 400	4 500			21.3	69.0	68.0	101.0	104.5	0.8	1.2	0.40	1.49	0.82	0.637	0.259
<b>60.325</b>	100.000	25.400	25.400	19.845	3.6	3.2	91.4	137	3 700	4 900	<b>28985</b> <b>28985</b> <b>5583R</b> <b>HM813841</b> <b>HM813841A</b> <b>65237</b> <b>65237A</b> <b>H715332</b>	<b>28921</b> <b>28920</b> <b>5535</b> <b>HM813811</b> <b>HM813810</b> <b>65500</b> <b>65500</b> <b>H715311</b>	22.8	73.0	67.0	89.0	96.0	3.6	3.2	0.43	1.41	0.78	0.533	0.230
	101.600	25.400	25.400	19.845	3.6	3.2	91.4	137	3 700	4 900			22.8	73.0	67.0	89.0	96.0	3.6	3.2	0.43	1.41	0.78	0.533	0.269
	122.238	43.658	43.764	36.512	3.6	3.2	221	318	3 200	4 300			31.1	78.0	72.0	106.0	116.0	3.6	3.2	0.36	1.67	0.92	1.66	0.807
	127.000	36.512	36.512	26.988	3.6	1.6	166	235	3 000	4 000			32.9	80.0	73.0	113.0	121.0	3.6	1.6	0.50	1.20	0.66	1.60	0.622
	127.000	36.512	36.512	26.988	1.6	3.2	166	235	3 000	4 000			32.9	74.0	71.0	110.0	121.0	1.6	3.2	0.50	1.20	0.66	1.62	0.606
	127.000	44.450	44.450	34.925	3.6	3.2	208	269	3 300	4 400			35.2	82.0	71.0	107.0	119.0	3.6	3.2	0.49	1.23	0.68	1.59	1.02
	127.000	44.450	44.450	34.925	1.6	3.2	208	269	3 300	4 400			35.2	78.0	71.0	107.0	119.0	1.6	3.2	0.49	1.23	0.68	1.59	1.02
	136.525	46.038	46.038	36.512	3.6	3.2	231	369	2 800	3 700			37.0	84.0	78.0	118.0	132.0	3.6	3.2	0.47	1.27	0.70	2.56	0.950
<b>61.912</b>	110.000	22.000	21.996	18.824	0.8	1.2	86.4	116	3 400	4 500	<b>392</b>	<b>394A</b>	21.3	70.0	69.0	101.0	104.5	0.8	1.2	0.40	1.49	0.82	0.606	0.259
<b>63.500</b>	107.950	25.400	25.400	19.050	1.6	3.2	92.8	143	3 400	4 500	<b>29586</b> <b>390A</b> <b>395</b> <b>29585</b> <b>39585</b> <b>477</b> <b>HM212046</b> <b>5584R</b> <b>565</b> <b>6382</b> <b>H414235</b>	<b>29520</b> <b>394A</b> <b>394A</b> <b>29521</b> <b>39520</b> <b>472</b> <b>HM212011</b> <b>5535</b> <b>563</b> <b>6320</b> <b>H414210</b>	24.7	73.0	71.0	96.0	103.0	1.6	3.2	0.46	1.31	0.72	0.649	0.277
	110.000	22.000	21.996	18.824	1.6	1.2	86.4	116	3 400	4 500			21.3	73.0	70.0	101.0	104.5	1.6	1.2	0.40	1.49	0.82	0.579	0.259
	110.000	22.000	21.996	18.824	3.6	1.2	86.4	116	3 400	4 500			21.3	77.0	70.0	101.0	104.5	3.6	1.2	0.40	1.49	0.82	0.575	0.259
	110.000	25.400	25.400	19.050	3.6	1.2	92.8	143	3 400	4 500			24.7	77.0	71.0	99.0	104.0	3.6	1.2	0.46	1.31	0.72	0.644	0.333
	112.712	30.162	30.162	23.812	3.6	3.2	147	207	3 300	4 500			23.3	77.0	71.0	101.0	107.0	3.6	3.2	0.34	1.77	0.97	0.908	0.355
	120.000	29.794	29.007	24.237	0.8	2.0	118	161	3 200	4 200			25.7	73.0	72.0	108.0	113.0	0.8	2.0	0.38	1.56	0.86	0.967	0.493
	122.238	38.354	38.100	29.718	3.6	3.2	191	249	3 200	4 300			27.6	80.0	73.0	108.0	116.0	3.6	3.2	0.34	1.78	0.98	1.36	0.591
	122.238	43.658	43.764	36.512	3.6	3.2	221	318	3 200	4 300			31.1	81.0	75.0	106.0	116.0	3.6	3.2	0.36	1.67	0.92	1.56	0.807
	127.000	36.512	36.170	28.575	3.6	3.2	156	226	3 000	4 000			28.6	80.0	73.0	112.0	120.0	3.6	3.2	0.36	1.65	0.91	1.43	0.648
	135.755	53.975	56.007	44.450	4.3	3.2	266	357	3 000	4 000			34.8	84.0	77.0	117.0	126.0	4.3	3.2	0.32	1.85	1.02	2.29	1.39
	136.525	41.275	41.275	31.750	3.6	3.2	241	308	2 900	3 800			30.3	82.0	78.0	121.0	129.0	3.6	3.2	0.36	1.67	0.92	2.11	0.796
	<b>64.986</b>	112.712	30.162	30.924	23.812	2.4	3.2	147	207	3 300			4 500	<b>39586</b>	<b>39520</b>	23.3	76.0	72.0	101.0	107.0	2.4	3.2	0.34	1.77
<b>65.000</b>	105.000	24.000	23.000	18.500	3.0	1.0	95.3	129	3 500	4 700	<b>JLM710949</b> <b>JM511946</b>	<b>JLM710910</b> <b>JM511910</b>	23.8	77.0	71.0	96.0	100.5	3.0	1.0	0.45	1.32	0.73	0.513	0.234
	110.000	28.000	28.000	22.500	3.0	2.8	136	191	3 400	4 600			24.5	78.0	72.0	99.0	105.0	3.0	2.8	0.40	1.49	0.82	0.733	0.338

[Note] 1) To the bearings with supplementary code "J" attached at the front of bearing number, tolerances shown in table 7-8 on page A66 are applied.

[Remark] Inch series tapered roller bearings with bore diameter larger than 100 mm are shown in catalog "large size ball & roller bearings".

Single-row tapered roller bearings  
inch series

$d$  (65.000) ~ 68.262 mm

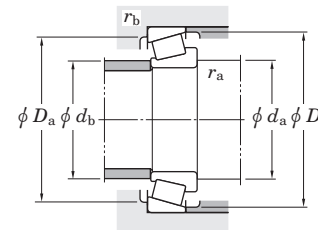
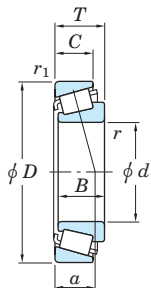

Boundary dimensions (mm)							Basic load ratings (kN)		Limiting speeds (min <sup>-1</sup> )		Load center (mm) $a$	Mounting dimensions (mm)						Constant $e$	Axial load factors		(Refer.) Mass (kg)						
$d$	$D$	$T$	$B$	$C$	$r_{min.}$	$r_{1min.}$	$C_r$	$C_{0r}$	Grease lub.	Oil lub.		Inner ring	Outer ring	$d_a$	$d_b$	$D_a$	$D_b$		$r_{a max.}$	$r_{b max.}$	$Y_1$	$Y_0$	Inner ring	Outer ring			
<b>65.000</b>	120.000	39.000	38.500	32.000	3.0	2.8	189	255	3 200	4 300	<b>JH211749</b>	<b>JH211710</b>	27.9	80.0	74.0	107.0	114.0	3.0	2.8	0.34	1.78	0.98	1.27	0.618			
	120.000	39.000	38.500	32.000	7.1	2.8	189	255	3 200	4 300			<b>JH211749A</b>	<b>JH211710</b>	27.9	88.0	74.0	107.0	114.0	7.1	2.8	0.34	1.78	0.98	1.27	0.618	
<b>65.088</b>	135.755	53.975	56.007	44.450	3.6	3.2	266	357	3 000	4 000	<b>6379</b>	<b>6320</b>	34.8	84.0	77.5	117.0	126.0	3.6	3.2	0.32	1.85	1.02	2.34	1.37			
	136.525	46.038	46.038	36.512	3.6	3.2	231	369	2 800	3 700			<b>H715340</b>	<b>H715311</b>	37.0	88.0	82.0	118.0	132.0	3.6	3.2	0.47	1.27	0.70	2.39	0.950	
<b>65.883</b>	122.238	43.658	43.764	36.512	3.6	3.2	221	318	3 200	4 300	<b>5595R</b>	<b>5535</b>	31.1	83.0	77.0	106.0	116.0	3.6	3.2	0.36	1.67	0.92	1.48	0.807			
<b>66.675</b>	110.000	22.000	21.996	18.824	0.8	1.2	86.4	116	3 400	4 500	<b>395A</b>	<b>394A</b>	21.3	73.0	73.0	101.0	104.5	0.8	1.2	0.40	1.49	0.82	0.524	0.259			
	110.000	22.000	21.996	18.824	3.6	1.2	86.4	116	3 400	4 500			<b>395S</b>	<b>394A</b>	21.3	79.0	73.0	101.0	104.5	3.6	1.2	0.40	1.49	0.82	0.519	0.259	
	112.712	30.162	30.048	23.812	3.6	0.8	111	164	3 400	4 500			<b>3984</b>	<b>3925</b>	25.9	80.0	74.0	101.0	106.0	3.6	0.8	0.40	1.49	0.82	0.700	0.454	
	112.712	30.162	30.162	23.812	3.6	3.2	147	207	3 300	4 500			<b>39590</b>	<b>39520</b>	23.3	80.0	74.0	101.0	107.0	3.6	3.2	0.34	1.77	0.97	0.832	0.355	
	112.712	30.162	30.162	23.812	3.6	0.8	147	207	3 300	4 500			<b>39590</b>	<b>39521</b>	23.3	80.0	74.0	103.0	107.0	3.6	0.8	0.34	1.77	0.97	0.832	0.360	
	117.475	30.162	30.162	23.812	3.6	3.2	118	179	3 200	4 200			<b>33262</b>	<b>33462</b>	27.8	81.0	75.0	104.0	112.0	3.6	3.2	0.44	1.38	0.76	0.910	0.436	
	122.238	38.100	38.354	29.718	3.6	1.6	191	249	3 200	4 300			<b>HM212049</b>	<b>HM212010</b>	27.3	82.0	75.5	110.0	116.0	3.6	1.6	0.34	1.78	0.98	1.26	0.596	
	127.000	36.512	36.512	26.988	3.6	1.6	166	235	3 000	4 000			<b>HM813844</b>	<b>HM813811</b>	32.9	85.0	78.0	113.0	121.0	3.6	1.6	0.50	1.20	0.66	1.42	0.622	
	130.175	41.275	41.275	31.750	3.6	3.2	197	267	3 000	3 900			<b>641</b>	<b>633</b>	30.3	83.0	77.0	116.0	124.0	3.6	3.2	0.36	1.66	0.91	1.68	0.703	
	135.755	53.975	56.007	44.450	4.3	3.2	266	357	3 000	4 000			<b>6386</b>	<b>6320</b>	34.8	87.0	77.5	117.0	126.0	4.3	3.2	0.32	1.85	1.02	2.27	1.37	
	135.755	53.975	56.007	44.450	6.4	3.2	266	357	3 000	4 000			<b>6389</b>	<b>6320</b>	34.8	91.0	77.5	117.0	126.0	6.4	3.2	0.32	1.85	1.02	2.15	1.37	
	136.525	41.275	41.275	31.750	3.6	3.2	241	308	2 900	3 800			<b>H414242</b>	<b>H414210</b>	30.3	85.0	81.0	121.0	129.0	3.6	3.2	0.36	1.67	0.92	2.01	0.796	
	136.525	46.038	46.038	36.512	3.6	3.2	231	369	2 800	3 700			<b>H715341</b>	<b>H715311</b>	37.0	89.0	83.0	118.0	132.0	3.6	3.2	0.47	1.27	0.70	2.33	0.950	
	<b>68.262</b>	110.000	22.000	21.996	18.824	2.4	1.2	86.4	116	3 400			4 500	<b>399A</b>	<b>394A</b>	21.3	78.0	74.0	101.0	104.5	2.4	1.2	0.40	1.49	0.82	0.493	0.259
		110.000	22.000	21.996	18.824	5.2	1.2	86.4	116	3 400			4 500			<b>399AS</b>	<b>394A</b>	21.3	83.0	74.0	101.0	104.5	5.2	1.2	0.40	1.49	0.82
117.475		30.162	30.162	23.812	3.6	3.2	118	179	3 200	4 200	<b>33269</b>	<b>33462</b>	27.8			82.0	76.0	104.0	112.0	3.6	3.2	0.44	1.38	0.76	0.870	0.436	
127.000		36.512	36.170	28.575	3.6	3.2	156	226	3 000	4 000	<b>570</b>	<b>563</b>	28.6			83.0	77.0	112.0	120.0	3.6	3.2	0.36	1.65	0.91	1.29	0.648	
136.525		41.275	41.275	31.750	3.6	3.2	241	308	2 900	3 800	<b>H414245</b>	<b>H414210</b>	30.3			86.0	82.0	121.0	129.0	3.6	3.2	0.36	1.67	0.92	1.92	0.788	
136.525		46.038	46.038	36.512	3.6	3.2	231	369	2 800	3 700	<b>H715343</b>	<b>H715311</b>	37.0			90.0	84.0	118.0	132.0	3.6	3.2	0.47	1.27	0.70	2.27	0.950	
152.400		47.625	46.038	31.750	3.6	3.2	244	278	2 700	3 600	<b>9185</b>	<b>9121</b>	44.5			94.0	81.5	130.0	145.0	3.6	3.2	0.66	0.91	0.50	2.67	1.20	

[Note] 1) To the bearings with supplementary code "J" attached at the front of bearing number, tolerances shown in table 7-8 on page A66 are applied.

[Remark] Inch series tapered roller bearings with bore diameter larger than 100 mm are shown in catalog "large size ball & roller bearings".

Single-row tapered roller bearings  
inch series

*d* 69.850 ~ (73.025) mm

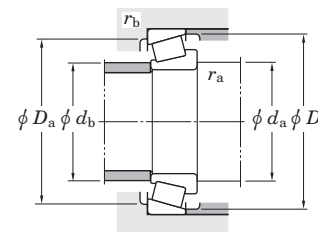
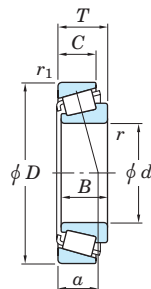

Boundary dimensions (mm)							Basic load ratings (kN)		Limiting speeds (min <sup>-1</sup> )		Bearing No. <sup>1)</sup>	Load center (mm) <i>a</i>	Mounting dimensions (mm)					Con-stant <i>e</i>	Axial load factors		(Refer.) Mass (kg)			
<i>d</i>	<i>D</i>	<i>T</i>	<i>B</i>	<i>C</i>	<i>r</i> <sub>min.</sub>	<i>r</i> <sub>1 min.</sub>	<i>C<sub>r</sub></i>	<i>C<sub>0r</sub></i>	Grease lub.	Oil lub.			Inner ring	Outer ring	<i>d<sub>a</sub></i>	<i>d<sub>b</sub></i>	<i>D<sub>a</sub></i>		<i>D<sub>b</sub></i>	<i>r<sub>a</sub></i> <sub>max.</sub>	<i>r<sub>b</sub></i> <sub>max.</sub>	<i>Y</i> <sub>1</sub>	<i>Y</i> <sub>0</sub>	Inner ring
69.850	98.425	13.495	13.495	9.525	1.6	1.6	39.3	59.8	3 500	4 700	LL713049	LL713010	18.4	77.0	74.0	92.0	94.0	1.6	1.6	0.44	1.37	0.75	0.205	0.086
	112.712	22.225	21.996	15.875	1.6	0.8	91.6	127	3 300	4 400	LM613449	LM613410	21.9	78.0	76.0	104.0	107.0	1.6	0.8	0.42	1.44	0.79	0.562	0.238
	112.712	25.400	25.400	19.050	1.6	3.2	97.0	155	3 200	4 300	29675	29620	26.2	80.0	77.0	101.0	109.0	1.6	3.2	0.49	1.23	0.68	0.676	0.270
	117.475	30.162	30.162	23.812	3.6	3.2	118	179	3 200	4 200	33275	33462	27.8	84.0	77.0	104.0	112.0	3.6	3.2	0.44	1.38	0.76	0.830	0.436
	120.000	29.002	29.007	23.444	3.6	3.2	118	161	3 200	4 200	482	472A	24.9	83.0	77.0	106.0	114.0	3.6	3.2	0.38	1.56	0.86	0.791	0.462
	120.000	29.794	29.007	24.237	3.6	2.0	118	161	3 200	4 200	482	472	25.7	83.0	77.0	108.0	113.0	3.6	2.0	0.38	1.56	0.86	0.791	0.487
	120.000	32.545	32.545	26.195	3.6	3.2	150	218	3 100	4 200	47487R	47420	26.6	84.0	78.0	107.0	114.0	3.6	3.2	0.36	1.67	0.92	1.01	0.476
	120.650	32.545	32.545	26.195	3.6	0.8	150	218	3 100	4 200	47487R	47423	26.6	84.0	78.0	109.0	114.0	3.6	0.8	0.36	1.67	0.92	1.01	0.513
	123.825	30.162	29.007	24.605	3.6	3.2	118	161	3 200	4 200	482	472X	26.0	83.0	77.0	109.0	114.0	3.6	3.2	0.38	1.56	0.86	0.791	0.625
	127.000	36.512	36.170	28.575	3.6	3.2	156	226	3 000	4 000	566	563	28.6	85.0	78.0	112.0	120.0	3.6	3.2	0.36	1.65	0.91	1.24	0.648
	146.050	41.275	41.275	31.750	3.6	3.2	208	301	2 600	3 400	655	653	33.4	88.0	82.0	131.0	139.0	3.6	3.2	0.41	1.47	0.81	2.35	0.891
	150.089	44.450	46.672	36.512	3.6	3.2	264	368	2 500	3 400	745AR	742	32.4	88.0	82.0	134.0	142.0	3.6	3.2	0.33	1.84	1.01	2.79	1.07
	168.275	53.975	56.363	41.275	3.6	3.2	344	467	2 300	3 100	835R	832	35.0	91.0	84.0	149.0	155.0	3.6	3.2	0.30	2.00	1.10	4.32	1.72
69.952	121.442	24.608	23.012	17.462	2.0	2.0	90.0	127	3 000	4 000	34274	34478	26.8	81.0	78.0	110.0	116.0	2.0	2.0	0.45	1.33	0.73	0.764	0.316
	115.000	29.000	29.000	23.000	3.0	2.5	123	173	3 200	4 300	JLM813049	JLM813010	26.1	78.0	77.0	98.0	105.0	1.0	2.5	0.49	1.23	0.68	0.590	0.300
70.000	115.000	29.000	29.000	23.000	3.0	2.5	123	173	3 200	4 300	JM612949	JM612910	26.2	83.0	77.0	103.0	110.0	3.0	2.5	0.43	1.39	0.77	0.776	0.358
	117.475	30.162	30.162	23.812	3.6	3.2	118	179	3 200	4 200	33281	33462	27.8	85.0	79.0	104.0	112.0	3.6	3.2	0.44	1.38	0.76	0.789	0.436
	120.000	32.545	32.545	26.195	3.6	3.2	150	218	3 100	4 200	47490R	47420	26.6	86.0	79.0	107.0	114.0	3.6	3.2	0.36	1.67	0.92	0.964	0.476
	127.000	36.512	36.170	28.575	3.6	3.2	156	226	3 000	4 000	567A	563	28.6	86.0	80.0	112.0	120.0	3.6	3.2	0.36	1.65	0.91	1.19	0.648
	127.000	36.512	36.512	26.988	3.6	1.6	166	235	3 000	4 000	HM813849	HM813811	32.9	89.0	81.9	113.0	121.0	3.6	1.6	0.50	1.20	0.66	1.28	0.622
	136.525	41.275	41.275	31.750	3.6	3.2	241	308	2 900	3 800	H414249	H414210	30.3	89.0	83.3	121.0	129.0	3.6	3.2	0.36	1.67	0.92	1.80	0.788
	136.525	46.038	46.038	36.512	3.6	3.2	231	369	2 800	3 700	H715345	H715311	37.0	93.0	87.0	118.0	132.0	3.6	3.2	0.47	1.27	0.70	2.15	0.950
73.025	112.712	25.400	25.400	19.050	3.6	3.2	97.0	155	3 200	4 300	29685	29620	26.2	86.0	80.0	101.0	109.0	3.6	3.2	0.49	1.23	0.68	0.602	0.270
	117.475	30.162	30.162	23.812	3.6	3.2	118	179	3 200	4 200	33287	33462	27.8	87.0	80.0	104.0	112.0	3.6	3.2	0.44	1.38	0.76	0.747	0.436
	127.000	36.512	36.170	28.575	3.6	3.2	156	226	3 000	4 000	567	563	28.6	88.0	81.0	112.0	120.0	3.6	3.2	0.36	1.65	0.91	1.14	0.648
	139.992	36.512	36.098	28.575	3.6	3.2	175	262	2 700	3 600	576R	572	31.0	90.0	83.0	125.0	133.0	3.6	3.2	0.40	1.49	0.82	1.74	0.779

[Note] 1) To the bearings with supplementary code "J" attached at the front of bearing number, tolerances shown in table 7-8 on page A66 are applied.

[Remark] Inch series tapered roller bearings with bore diameter larger than 100 mm are shown in catalog "large size ball & roller bearings".



Single-row tapered roller bearings  
inch series

$d$  (73.025) ~ 76.200 mm

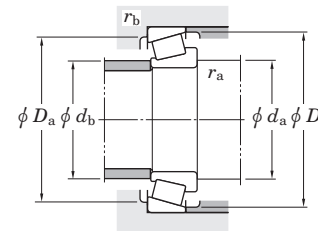
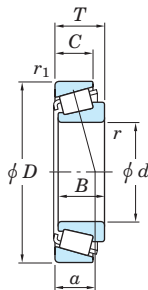

Boundary dimensions (mm)							Basic load ratings (kN)		Limiting speeds (min <sup>-1</sup> )		Bearing No. <sup>1)</sup>	Load center (mm) a	Mounting dimensions (mm)					Constant e	Axial load factors		(Refer.) Mass (kg)					
d	D	T	B	C	r min.	r <sub>1</sub> min.	C <sub>r</sub>	C <sub>0r</sub>	Grease lub.	Oil lub.			Inner ring	Outer ring	d <sub>a</sub>	d <sub>b</sub>	D <sub>a</sub>		D <sub>b</sub>	r <sub>a</sub> max.	r <sub>b</sub> max.	Y <sub>1</sub>	Y <sub>0</sub>	Inner ring	Outer ring	
<b>73.025</b>	146.050	41.275	41.275	31.750	3.6	3.2	208	301	2 600	3 400	<b>657</b>	<b>653</b>	33.4	90.0	85.0	131.0	139.0	3.6	3.2	0.41	1.47	0.81	2.28	0.880		
	149.225	53.975	54.229	44.450	3.6	3.2	285	404	2 700	3 500			<b>6460</b>	<b>6420</b>	39.3	93.0	87.0	129.0	141.0	3.6	3.2	0.36	1.66	0.91	2.79	1.61
	150.089	44.450	46.672	36.512	3.6	3.2	264	368	2 500	3 400			<b>744R</b>	<b>742</b>	32.4	91.0	85.0	134.0	142.0	3.6	3.2	0.33	1.84	1.01	2.66	1.07
	161.925	47.625	48.260	38.100	3.6	3.2	273	391	2 400	3 200			<b>762</b>	<b>752</b>	35.5	92.0	97.0	144.0	150.0	3.6	3.2	0.34	1.76	0.97	3.18	1.61
<b>73.817</b>	112.712	25.400	25.400	19.050	1.6	3.2	97.0	155	3 200	4 300	<b>29688</b>	<b>29620</b>	26.2	83.0	81.0	101.0	109.0	1.6	3.2	0.49	1.23	0.68	0.588	0.270		
	127.000	36.512	36.170	28.575	0.8	3.2	156	226	3 000	4 000			<b>568</b>	<b>563</b>	28.6	83.0	82.0	112.0	120.0	0.8	3.2	0.36	1.65	0.91	1.12	0.648
<b>74.612</b>	139.992	36.512	36.098	28.575	3.6	3.2	175	262	2 700	3 600	<b>577R</b>	<b>572</b>	31.0	91.0	85.0	125.0	133.0	3.6	3.2	0.40	1.49	0.82	1.69	0.779		
<b>75.000</b>	115.000	25.000	25.000	19.000	3.0	2.8	101	151	3 100	4 200	<b>JLM714149</b>	<b>JLM714110</b>	25.5	87.0	81.0	104.0	110.0	3.0	2.8	0.46	1.31	0.72	0.612	0.269		
	120.000	31.000	29.500	25.000	3.0	2.8	145	216	3 100	4 100			<b>JM714249</b>	<b>JM714210</b>	30.0	88.0	82.9	108.0	115.0	3.0	2.8	0.44	1.35	0.74	0.846	0.430
	145.000	51.000	51.000	42.000	3.0	2.5	290	412	2 700	3 600			<b>JH415647</b>	<b>JH415610</b>	36.6	94.0	89.0	129.0	139.0	3.0	2.5	0.36	1.66	0.91	2.66	1.18
<b>76.200</b>	121.442	24.608	23.012	17.462	3.6	2.0	90.0	127	3 000	4 000	<b>34301</b>	<b>34478</b>	26.8	89.0	83.0	110.0	116.0	3.6	2.0	0.45	1.33	0.73	0.617	0.313		
	127.000	30.162	31.000	22.225	3.6	3.2	143	225	2 400	3 200			<b>42687</b>	<b>42620</b>	27.1	90.0	84.0	114.0	121.0	3.6	3.2	0.42	1.43	0.79	1.05	0.434
	127.000	30.162	31.000	22.225	6.4	3.2	143	225	2 400	3 200			<b>42688</b>	<b>42620</b>	27.1	96.0	84.0	114.0	121.0	6.4	3.2	0.42	1.43	0.79	1.04	0.434
	133.350	30.162	29.769	22.225	6.4	3.2	133	198	2 700	3 600			<b>495AX</b>	<b>492A</b>	29.8	98.0	86.0	120.0	128.0	6.4	3.2	0.44	1.35	0.74	1.20	0.430
	133.350	33.338	33.338	26.195	6.4	3.2	154	245	2 700	3 700			<b>47678R</b>	<b>47620</b>	29.2	97.0	90.0	119.0	128.0	6.4	3.2	0.40	1.48	0.82	1.29	0.577
	133.350	33.338	33.338	26.195	0.8	3.2	154	245	2 700	3 700			<b>47680R</b>	<b>47620</b>	29.2	86.0	85.0	119.0	128.0	0.8	3.2	0.40	1.48	0.82	1.39	0.577
	135.733	44.450	46.101	34.925	3.6	3.2	213	337	2 800	3 700			<b>5760</b>	<b>5735</b>	33.0	94.0	88.0	119.0	130.0	3.6	3.2	0.41	1.48	0.81	1.85	0.877
	136.525	30.162	29.769	22.225	3.6	3.2	133	198	2 700	3 600			<b>495A</b>	<b>493</b>	29.8	92.0	86.0	122.0	130.0	3.6	3.2	0.44	1.35	0.74	1.26	0.544
	139.992	36.512	36.098	28.575	3.6	3.2	175	262	2 700	3 600			<b>575R</b>	<b>572</b>	31.0	92.0	86.0	125.0	133.0	3.6	3.2	0.40	1.49	0.82	1.64	0.779
	139.992	36.512	36.098	28.575	6.7	3.2	175	262	2 700	3 600			<b>575SR</b>	<b>572</b>	31.0	99.0	86.0	125.0	133.0	6.7	3.2	0.40	1.49	0.82	1.61	0.779
	149.225	53.975	54.229	44.450	3.6	3.2	285	404	2 700	3 500			<b>6461</b>	<b>6420</b>	39.3	96.0	89.5	129.0	141.0	3.6	3.2	0.36	1.66	0.91	2.64	1.61
	149.225	53.975	54.229	44.450	9.5	3.2	285	404	2 700	3 500			<b>6461A</b>	<b>6420</b>	39.3	105.0	90.0	129.0	141.0	9.5	3.2	0.36	1.66	0.91	2.60	1.61
	150.089	44.450	46.672	36.512	3.6	3.2	264	368	2 500	3 400			<b>748SR</b>	<b>742</b>	32.4	93.0	87.0	134.0	142.0	3.6	3.2	0.33	1.84	1.01	2.51	1.06
	152.400	41.275	41.275	31.750	3.6	3.2	208	301	2 600	3 400			<b>659</b>	<b>652</b>	33.4	93.0	87.0	134.0	141.0	3.6	3.2	0.41	1.47	0.81	2.16	1.25
	190.500	57.150	57.531	46.038	3.6	3.2	440	602	2 000	2 700			<b>HH221430</b>	<b>HH221410</b>	42.5	101.0	95.0	171.0	179.0	3.6	3.2	0.33	1.79	0.99	6.33	2.21

[Note] 1) To the bearings with supplementary code "J" attached at the front of bearing number, tolerances shown in table 7-8 on page A66 are applied.

[Remark] Inch series tapered roller bearings with bore diameter larger than 100 mm are shown in catalog "large size ball & roller bearings".

Single-row tapered roller bearings  
inch series

*d* 77.788 ~ (83.345) mm

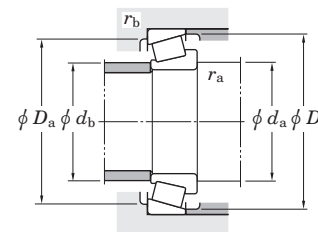
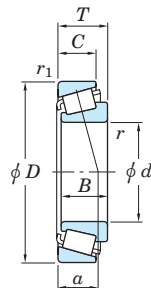

Boundary dimensions (mm)							Basic load ratings (kN)		Limiting speeds (min <sup>-1</sup> )		Bearing No. <sup>1)</sup>	Load center (mm) <i>a</i>	Mounting dimensions (mm)						Constant <i>e</i>	Axial load factors		(Refer.) Mass (kg)				
<i>d</i>	<i>D</i>	<i>T</i>	<i>B</i>	<i>C</i>	<i>r</i> <sub>min.</sub>	<i>r</i> <sub>1 min.</sub>	<i>C<sub>r</sub></i>	<i>C<sub>0r</sub></i>	Grease lub.	Oil lub.			Inner ring	Outer ring	<i>d<sub>a</sub></i>	<i>d<sub>b</sub></i>	<i>D<sub>a</sub></i>	<i>D<sub>b</sub></i>		<i>r<sub>a</sub></i> <sub>max.</sub>	<i>r<sub>b</sub></i> <sub>max.</sub>	<i>Y</i> <sub>1</sub>	<i>Y</i> <sub>0</sub>	Inner ring	Outer ring	
<b>77.788</b>	117.475	25.400	25.400	19.050	3.6	3.2	101	166	3 100	4 100	<b>LM814849</b>	<b>LM814810</b>	27.6	91.0	85.0	105.0	113.0	3.6	3.2	0.51	1.18	0.65	0.619	0.295		
	121.442	24.608	23.012	17.462	3.6	2.0	90.0	127	3 000	4 000			<b>34306</b>	<b>34478</b>	26.8	90.0	84.0	110.0	116.0	3.6	2.0	0.45	1.33	0.73	0.583	0.313
	121.442	24.608	23.012	17.462	6.4	2.0	90.0	127	3 000	4 000			<b>34307</b>	<b>34478</b>	26.8	96.0	84.0	110.0	116.0	6.4	2.0	0.45	1.33	0.73	0.571	0.313
	127.000	30.162	31.000	22.225	3.6	3.2	143	225	2 400	3 200			<b>42690</b>	<b>42620</b>	27.1	91.0	85.0	114.0	121.0	3.6	3.2	0.42	1.43	0.79	1.00	0.434
<b>79.375</b>	146.050	41.275	41.275	31.750	3.6	3.2	208	301	2 600	3 400	<b>661</b>	<b>653</b>	33.4	96.0	90.0	131.0	139.0	3.6	3.2	0.41	1.47	0.81	2.04	0.880		
	161.925	47.625	48.260	38.100	7.9	3.2	273	391	2 400	3 200			<b>756A</b>	<b>752</b>	35.5	106.0	91.0	144.0	150.0	7.9	3.2	0.34	1.76	0.97	2.95	1.59
	190.500	57.150	57.531	46.038	3.6	3.2	440	602	2 000	2 700			<b>HH221431</b>	<b>HH221410</b>	42.5	103.0	97.0	171.0	179.0	3.6	3.2	0.33	1.79	0.99	6.16	2.21
<b>80.000</b>	130.000	35.000	34.000	28.500	3.2	2.5	168	256	2 800	3 800	<b>JM515649</b>	<b>JM515610</b>	29.6	94.0	88.0	117.0	125.0	3.2	2.5	0.39	1.54	0.85	1.19	0.575		
	200.000	52.761	49.212	34.925	3.6	3.2	347	471	1 400	1 900			<b>98316</b>	<b>98788</b>	54.5	111.0	105.0	174.0	188.0	3.6	3.2	0.63	0.95	0.52	5.73	2.28
<b>80.962</b>	133.350	30.162	29.769	22.225	3.6	3.2	133	198	2 700	3 600	<b>496</b>	<b>492A</b>	29.8	95.0	89.0	120.0	128.0	3.6	3.2	0.44	1.35	0.74	1.12	0.429		
	133.350	33.338	33.338	26.195	3.6	3.2	154	245	2 700	3 700			<b>47681R</b>	<b>47620</b>	29.2	95.0	89.0	119.0	128.0	3.6	3.2	0.40	1.48	0.82	1.17	0.577
	139.992	36.512	36.098	28.575	3.6	3.2	175	262	2 700	3 600			<b>581R</b>	<b>572</b>	31.0	96.0	90.0	125.0	133.0	3.6	3.2	0.40	1.49	0.82	1.47	0.779
	150.089	44.450	46.672	36.512	5.2	3.2	264	368	2 500	3 400			<b>740R</b>	<b>742</b>	32.4	101.0	91.0	134.0	142.0	5.2	3.2	0.33	1.84	1.01	2.30	1.06
<b>82.550</b>	125.412	25.400	25.400	19.845	3.6	1.6	101	162	2 900	3 800	<b>27687</b>	<b>27620</b>	24.7	96.0	89.0	115.0	120.0	3.6	1.6	0.42	1.44	0.79	0.710	0.344		
	133.350	30.162	29.769	22.225	3.6	3.2	133	198	2 700	3 600			<b>495</b>	<b>492A</b>	29.8	97.0	90.0	120.0	128.0	3.6	3.2	0.44	1.35	0.74	1.08	0.429
	133.350	33.338	33.338	26.195	3.6	0.8	154	245	2 700	3 700			<b>47686R</b>	<b>47620A</b>	29.2	97.0	90.0	121.0	128.0	3.6	0.8	0.40	1.48	0.82	1.13	0.577
	133.350	39.688	39.688	32.545	6.7	3.2	177	306	2 800	3 700	<b>HM516448</b>	<b>HM516410</b>	32.2	105.0	92.0	118.0	128.0	6.7	3.2	0.40	1.49	0.82	1.33	0.763		
	139.700	36.512	36.098	28.575	3.6	3.2	175	262	2 700	3 600			<b>580R</b>	<b>572X</b>	31.0	98.0	91.0	125.0	133.0	3.6	3.2	0.40	1.49	0.82	1.41	0.765
	139.992	36.512	36.098	28.575	3.6	3.2	175	262	2 700	3 600			<b>580R</b>	<b>572</b>	31.0	98.0	91.0	125.0	133.0	3.6	3.2	0.40	1.49	0.82	1.41	0.779
	139.992	36.512	36.098	28.575	6.7	3.2	175	262	2 700	3 600	<b>582R</b>	<b>572</b>	31.0	104.0	91.0	125.0	133.0	6.7	3.2	0.40	1.49	0.82	1.40	0.779		
	146.050	41.275	41.275	31.750	3.6	3.2	208	301	2 600	3 400	<b>663</b>	<b>653</b>	33.4	99.0	92.0	131.0	139.0	3.6	3.2	0.41	1.47	0.81	1.91	0.880		
	150.089	44.450	46.672	36.512	3.6	3.2	264	368	2 500	3 400	<b>749AR</b>	<b>742</b>	32.4	99.0	93.0	134.0	142.0	3.6	3.2	0.33	1.84	1.01	2.23	1.06		
	150.089	44.450	46.672	36.512	6.7	3.2	264	368	2 500	3 400	<b>750AR</b>	<b>742</b>	32.4	106.0	93.0	134.0	142.0	6.7	3.2	0.33	1.84	1.01	2.19	1.06		
	161.925	47.625	48.260	38.100	3.6	3.2	273	391	2 400	3 200	<b>757</b>	<b>752</b>	35.5	100.0	94.0	144.0	150.0	3.6	3.2	0.34	1.76	0.97	2.83	1.59		
	<b>83.345</b>	125.412	25.400	25.400	19.845	0.8	1.6	101	162	2 900	3 800	<b>27689</b>	<b>27620</b>	24.7	90.0	90.0	115.0	120.0	0.8	1.6	0.42	1.44	0.79	0.746	0.344	

[Note] 1) To the bearings with supplementary code "J" attached at the front of bearing number, tolerances shown in table 7-8 on page A66 are applied.

[Remark] Inch series tapered roller bearings with bore diameter larger than 100 mm are shown in catalog "large size ball & roller bearings".

Single-row tapered roller bearings  
inch series

$d$  (83.345) ~ (88.900) mm

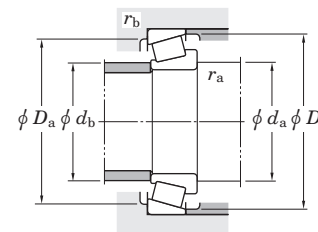
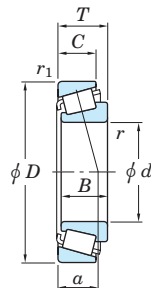

Boundary dimensions (mm)							Basic load ratings (kN)		Limiting speeds (min <sup>-1</sup> )		Bearing No. <sup>1)</sup>	Load center (mm) $a$	Mounting dimensions (mm)						Constant $e$	Axial load factors		(Refer.) Mass (kg)		
$d$	$D$	$T$	$B$	$C$	$r_{min.}$	$r_{1 min.}$	$C_r$	$C_{0r}$	Grease lub.	Oil lub.			Inner ring	Outer ring	$d_a$	$d_b$	$D_a$	$D_b$		$r_{a max.}$	$r_{b max.}$	$Y_1$	$Y_0$	Inner ring
<b>83.345</b>	125.412	25.400	25.400	19.845	3.6	1.6	101	162	2 900	3 800	<b>27690</b>	<b>27620</b>	24.7	96.0	90.0	115.0	120.0	3.6	1.6	0.42	1.44	0.79	0.689	0.344
	125.412	25.400	25.400	19.845	6.4	1.6	101	162	2 900	3 800			24.7	102.0	90.0	115.0	120.0	6.4	1.6	0.42	1.44	0.79	0.646	0.344
<b>84.138</b>	133.350	30.162	29.769	22.225	3.6	3.2	133	198	2 700	3 600	<b>498</b>	<b>492A</b>	29.8	98.0	91.0	120.0	128.0	3.6	3.2	0.44	1.35	0.74	1.04	0.429
<b>85.000</b>	130.000	30.000	29.000	24.000	3.0	2.5	142	228	2 800	3 700	<b>JM716649</b>	<b>JM716610</b>	29.1	98.0	92.0	117.0	125.0	3.0	2.5	0.44	1.35	0.74	0.937	0.456
	140.000	39.000	38.000	31.500	3.0	2.5	203	308	2 700	3 500			32.8	100.0	93.9	125.0	134.0	3.0	2.5	0.41	1.47	0.81	1.54	0.759
	150.000	46.000	46.000	38.000	3.0	2.5	274	390	2 500	3 400			33.6	101.0	95.2	134.0	142.0	3.0	2.5	0.33	1.80	0.99	2.28	1.08
	200.000	52.761	49.212	34.925	3.6	3.2	347	471	1 400	1 900			54.5	115.0	109.0	174.0	188.0	3.6	3.2	0.63	0.95	0.52	5.47	2.28
<b>85.026</b>	150.089	44.450	46.672	36.512	3.6	3.2	264	368	2 500	3 400	<b>749R</b>	<b>742</b>	32.4	101.0	95.0	134.0	142.0	3.6	3.2	0.33	1.84	1.01	2.12	1.06
	150.089	44.450	46.672	36.512	5.2	3.2	264	368	2 500	3 400			32.4	104.0	95.0	134.0	142.0	5.2	3.2	0.33	1.84	1.01	2.08	1.06
<b>85.725</b>	133.350	30.162	29.769	22.225	3.6	3.2	133	198	2 700	3 600	<b>497</b>	<b>492A</b>	29.8	99.0	93.0	120.0	128.0	3.6	3.2	0.44	1.35	0.74	0.978	0.429
	136.525	30.162	29.769	22.225	6.4	3.2	133	198	2 700	3 600			29.8	105.0	93.0	122.0	130.0	6.4	3.2	0.44	1.35	0.74	0.965	0.544
	142.138	42.862	42.862	34.133	4.8	3.2	219	351	2 600	3 500			35.2	106.0	95.7	125.0	137.0	4.8	3.2	0.43	1.39	0.76	1.72	0.902
	146.050	41.275	41.275	31.750	3.6	3.2	208	301	2 600	3 400			33.4	102.0	95.0	131.0	139.0	3.6	3.2	0.41	1.47	0.81	1.77	0.880
	146.050	41.275	41.275	31.750	6.4	3.2	208	301	2 600	3 400			33.4	107.0	95.0	131.0	139.0	6.4	3.2	0.41	1.47	0.81	1.76	0.880
	152.400	39.688	36.322	30.162	3.6	3.2	183	287	2 400	3 300			37.1	102.0	96.0	135.0	144.0	3.6	3.2	0.44	1.36	0.75	1.83	1.04
	161.925	47.625	48.260	38.100	3.6	3.2	273	391	2 400	3 200			35.5	103.0	97.0	144.0	150.0	3.6	3.2	0.34	1.76	0.97	2.67	1.59
	168.275	41.275	41.275	30.162	3.6	3.2	224	349	2 200	3 000			38.6	105.0	99.0	149.0	160.0	3.6	3.2	0.47	1.28	0.70	2.89	1.22
	168.275	53.975	56.363	41.275	3.6	3.2	344	467	2 300	3 100			35.0	104.0	97.0	149.0	155.0	3.6	3.2	0.30	2.00	1.10	3.47	1.72
	<b>88.900</b>	123.825	20.638	20.638	16.670	1.6	1.6	81.8	145	2 800			3 700	<b>L217849</b>	<b>L217810</b>	20.7	97.0	94.0	116.0	119.0	1.6	1.6	0.33	1.82
152.400		39.688	39.688	30.162	6.4	3.2	248	359	2 400	3 200	33.1	110.0	98.0			135.0	114.0	6.4	3.2	0.40	1.49	0.82	2.10	0.768
161.925		47.625	48.260	38.100	3.6	3.2	273	391	2 400	3 200	35.5	106.0	99.0			144.0	150.0	3.6	3.2	0.34	1.76	0.97	2.50	1.59
161.925		47.625	48.260	38.100	7.1	3.2	273	391	2 400	3 200	35.5	113.0	99.0			144.0	150.0	7.1	3.2	0.34	1.76	0.97	2.48	1.59
161.925		53.975	55.100	42.862	3.6	3.2	316	471	2 400	3 200	49.8	109.0	98.0			141.0	154.0	3.6	3.2	0.40	1.50	0.82	3.09	1.65
168.275		41.275	41.275	30.162	3.6	3.2	224	349	2 200	3 000	38.6	107.0	101.0			149.0	160.0	3.6	3.2	0.47	1.28	0.70	2.75	1.22
190.500		57.150	57.531	44.450	7.9	3.2	385	565	2 100	2 700	40.0	118.0	103.0			170.0	174.0	7.9	3.2	0.33	1.79	0.99	5.05	2.66

[Note] 1) To the bearings with supplementary code "J" attached at the front of bearing number, tolerances shown in table 7-8 on page A66 are applied.

[Remark] Inch series tapered roller bearings with bore diameter larger than 100 mm are shown in catalog "large size ball & roller bearings".

Single-row tapered roller bearings  
inch series

$d$  (88.900) ~ 99.975 mm

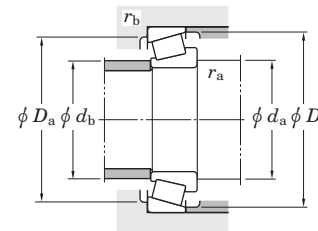
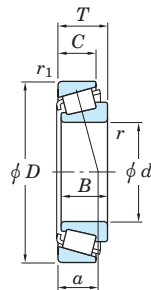

Boundary dimensions (mm)							Basic load ratings (kN)		Limiting speeds (min <sup>-1</sup> )		Bearing No. <sup>1)</sup>	Load center (mm) a	Mounting dimensions (mm)					Constant e	Axial load factors		(Refer.) Mass (kg)					
d	D	T	B	C	r min.	r <sub>1</sub> min.	C <sub>r</sub>	C <sub>0r</sub>	Grease lub.	Oil lub.			Inner ring	Outer ring	d <sub>a</sub>	d <sub>b</sub>	D <sub>a</sub>		D <sub>b</sub>	r <sub>a</sub> max.	r <sub>b</sub> max.	Y <sub>1</sub>	Y <sub>0</sub>	Inner ring	Outer ring	
<b>88.900</b>	190.500	57.150	57.531	46.038	7.9	3.2	440	602	2 000	2 700	<b>HH221434</b>	<b>HH221410</b>	42.5	120.0	105.0	171.0	179.0	7.9	3.2	0.33	1.79	0.99	5.57	2.21		
	200.000	52.761	49.212	34.925	3.6	3.2	347	471	1 400	1 900			<b>98350</b>	<b>98788</b>	54.5	118.0	112.0	174.0	188.0	3.6	3.2	0.63	0.95	0.52	5.27	2.28
<b>89.974</b>	146.975	40.000	40.000	32.500	7.1	3.6	206	310	2 500	3 300	<b>HM218248</b>	<b>HM218210</b>	30.8	112.0	99.0	133.0	141.0	7.1	3.6	0.33	1.80	0.99	1.66	0.784		
<b>90.000</b>	145.000	35.000	34.000	27.000	3.0	2.5	194	291	2 500	3 400	<b>JM718149</b>	<b>JM718110</b>	32.7	105.0	99.0	131.0	139.0	3.0	2.5	0.44	1.35	0.74	1.47	0.652		
	155.000	44.000	44.000	35.500	3.0	2.5	290	407	2 400	3 200			<b>JHM318448</b>	<b>JHM318410</b>	34.5	106.0	100.0	140.0	148.0	3.0	2.5	0.34	1.76	0.97	2.37	1.00
	161.925	53.975	55.100	42.862	3.0	3.2	316	471	2 400	3 200			<b>6581XR</b>	<b>6535</b>	41.0	102.0	98.0	141.0	154.0	3.0	3.2	0.40	1.50	0.82	3.02	1.65
<b>90.488</b>	161.925	47.625	48.260	38.100	3.6	3.2	273	391	2 400	3 200	<b>760</b>	<b>752</b>	35.5	107.0	101.0	144.0	150.0	3.6	3.2	0.34	1.76	0.97	2.42	1.59		
<b>92.075</b>	146.050	33.338	34.925	26.195	3.6	3.2	178	293	2 500	3 300	<b>47890R</b>	<b>47820</b>	32.6	107.0	101.0	131.0	140.0	3.6	3.2	0.45	1.34	0.74	1.46	0.657		
	168.275	41.275	41.275	30.162	3.6	3.2	224	349	2 200	3 000			<b>681</b>	<b>672</b>	38.6	110.0	104.0	149.0	160.0	3.6	3.2	0.47	1.28	0.70	2.61	1.22
	168.275	41.275	41.275	30.162	6.4	3.2	224	349	2 200	3 000			<b>681A</b>	<b>672</b>	38.6	116.0	104.0	149.0	160.0	6.4	3.2	0.47	1.28	0.70	2.60	1.22
	180.975	47.625	48.006	38.100	3.6	3.2	288	438	2 100	2 800			<b>778</b>	<b>772</b>	39.5	111.0	105.0	161.0	168.0	3.6	3.2	0.39	1.56	0.86	3.65	1.92
	190.500	57.150	57.531	44.450	7.9	3.2	385	565	2 100	2 700			<b>857R</b>	<b>854</b>	39.9	121.0	106.0	170.0	174.0	7.9	3.2	0.33	1.79	0.99	4.86	2.66
<b>95.000</b>	150.000	35.000	34.000	27.000	3.0	2.5	187	294	2 400	3 300	<b>JM719149</b>	<b>JM719113</b>	33.5	109.0	104.0	135.0	143.0	3.0	2.5	0.44	1.36	0.75	1.43	0.766		
<b>95.250</b>	128.588	15.875	15.083	11.908	1.6	1.6	58.0	93.0	2 600	3 500	<b>LL319349</b>	<b>LL319310</b>	20.3	103.0	100.0	122.0	124.0	1.6	1.6	0.35	1.71	0.94	0.393	0.147		
	130.175	20.638	21.432	16.670	1.6	1.6	97.0	167	2 600	3 500			<b>L319249</b>	<b>L319210</b>	22.2	107.0	101.0	122.0	125.0	1.6	1.6	0.35	1.72	0.95	0.548	0.246
	146.050	33.338	34.925	26.195	3.6	3.2	178	293	2 500	3 300			<b>47896R</b>	<b>47820</b>	32.6	110.0	103.0	131.0	140.0	3.6	3.2	0.45	1.34	0.74	1.34	0.657
	147.638	35.717	36.322	26.192	5.2	0.8	183	287	2 400	3 300			<b>594A</b>	<b>592XE</b>	33.4	113.0	104.0	135.0	142.0	5.2	0.8	0.44	1.36	0.75	1.45	0.620
	157.162	36.512	36.116	26.195	3.6	3.2	180	288	2 300	3 000			<b>52375</b>	<b>52618</b>	36.0	112.0	105.0	142.0	152.0	3.6	3.2	0.47	1.26	0.69	1.94	0.694
	168.275	41.275	41.275	30.162	3.6	3.2	224	349	2 200	3 000			<b>683</b>	<b>672</b>	38.6	113.0	106.0	149.0	160.0	3.6	3.2	0.47	1.28	0.70	2.46	1.22
	190.500	57.150	57.531	44.450	7.9	3.2	385	565	2 100	2 700			<b>864R</b>	<b>854</b>	39.9	123.0	108.0	170.0	174.0	7.9	3.2	0.33	1.79	0.99	4.64	2.66
	190.500	57.150	57.531	46.038	7.9	3.2	440	602	2 000	2 700			<b>HH221440</b>	<b>HH221410</b>	42.5	125.0	110.0	171.0	179.0	7.9	3.2	0.33	1.79	0.99	5.16	2.21
	<b>98.425</b>	168.275	41.275	41.275	30.162	3.6	3.2	224	349	2 200			3 000	<b>685</b>	<b>672</b>	38.6	116.0	109.0	149.0	160.0	3.6	3.2	0.47	1.28	0.70	2.29
190.500		57.150	57.531	46.038	3.6	3.2	440	602	2 000	2 700	<b>HH221442</b>	<b>HH221410</b>	42.5			119.0	113.0	171.0	179.0	3.6	3.2	0.33	1.79	0.99	4.97	2.21
<b>99.975</b>	212.725	66.675	66.675	53.975	3.6	3.2	513	699	1 800	2 400	<b>HH224334</b>	<b>HH224310</b>	47.6	122.0	117.0	192.0	202.0	3.6	3.2	0.33	1.84	1.01	7.91	3.03		

[Note] 1) To the bearings with supplementary code "J" attached at the front of bearing number, tolerances shown in table 7-8 on page A66 are applied.

[Remark] Inch series tapered roller bearings with bore diameter larger than 100 mm are shown in catalog "large size ball & roller bearings".

Single-row tapered roller bearings  
inch series

$d$  99.982 ~ (107.950) mm

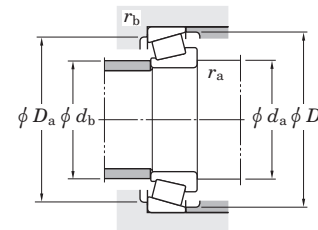
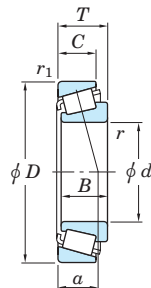

Boundary dimensions (mm)							Basic load ratings (kN)		Limiting speeds (min <sup>-1</sup> )		Bearing No. <sup>1)</sup>	Load center (mm) a	Mounting dimensions (mm)						Constant e	Axial load factors		(Refer.) Mass (kg)		
d	D	T	B	C	r min.	r <sub>1</sub> min.	C <sub>r</sub>	C <sub>0r</sub>	Grease lub.	Oil lub.			Inner ring	Outer ring	d <sub>a</sub>	d <sub>b</sub>	D <sub>a</sub>	D <sub>b</sub>		r <sub>a</sub> max.	r <sub>b</sub> max.	Y <sub>1</sub>	Y <sub>0</sub>	Inner ring
<b>99.982</b>	190.500	57.150	57.531	46.038	6.4	3.2	440	602	2 000	2 700	<b>HH221447</b>	<b>HH221410</b>	42.5	126.0	114.0	171.0	179.0	6.4	3.2	0.33	1.79	0.99	4.84	2.21
<b>100.000</b>	155.000	36.000	35.000	28.000	3.0	2.5	204	328	2 300	3 100	<b>JM720249</b>	<b>JM720210</b>	35.6	110.0	110.0	139.0	148.0	3.0	2.5	0.47	1.27	0.70	1.64	0.763
	160.000	41.000	40.000	32.000	3.0	2.5	237	378	2 300	3 000	<b>JHM720249</b>	<b>JHM720210</b>	38.3	110.0	111.0	143.0	153.0	3.0	2.5	0.47	1.28	0.70	2.11	0.964
<b>100.012</b>	157.162	36.512	36.116	26.195	3.6	3.2	180	288	2 300	3 000	<b>52393</b>	<b>52618</b>	36.0	113.0	115.0	142.0	150.0	3.6	3.2	0.47	1.26	0.69	1.74	0.694
<b>101.600</b>	157.162	36.512	36.116	26.195	3.6	3.2	180	288	2 300	3 000	<b>52400</b>	<b>52618</b>	36.0	114.0	115.0	142.0	150.0	3.6	3.2	0.47	1.26	0.69	1.67	0.694
	157.162	36.512	36.116	26.195	7.9	3.2	180	288	2 300	3 000	<b>52401</b>	<b>52618</b>	36.0	126.0	111.0	142.0	152.0	7.9	3.2	0.47	1.26	0.69	1.64	0.694
	168.275	41.275	41.275	30.162	3.6	3.2	224	349	2 200	3 000	<b>687</b>	<b>672</b>	38.6	114.0	115.0	146.0	156.0	3.6	3.2	0.47	1.28	0.70	2.15	1.22
	180.975	47.625	48.006	38.100	3.6	3.2	288	438	2 100	2 800	<b>780</b>	<b>772</b>	39.5	114.0	120.0	156.0	165.0	3.6	3.2	0.39	1.56	0.86	3.09	1.92
	190.500	57.150	57.531	44.450	7.9	3.2	385	565	2 100	2 700	<b>861R</b>	<b>854</b>	39.9	129.0	114.0	170.0	174.0	7.9	3.2	0.33	1.79	0.99	4.20	2.66
	190.500	57.150	57.531	46.038	7.9	3.2	440	602	2 000	2 700	<b>HH221449</b>	<b>HH221410</b>	42.5	123.0	119.0	168.0	178.0	7.9	3.2	0.33	1.79	0.99	4.72	2.21
	200.000	52.761	49.212	34.925	3.6	3.2	347	471	1 400	1 900	<b>98400</b>	<b>98788</b>	54.5	114.0	123.0	170.0	185.0	3.6	3.2	0.63	0.95	0.52	4.55	2.28
	212.725	66.675	66.675	53.975	7.1	3.2	450	674	1 800	2 400	<b>941</b>	<b>932</b>	47.6	121.0	135.0	181.0	192.0	7.1	3.2	0.33	1.84	1.01	7.07	4.07
	212.725	66.675	66.675	53.975	7.1	3.2	513	699	1 800	2 400	<b>HH224335</b>	<b>HH224310</b>	47.6	121.0	134.0	189.0	201.0	7.1	3.2	0.33	1.84	1.01	7.76	3.03
<b>104.775</b>	180.975	47.625	48.006	38.100	3.6	3.2	288	438	2 100	2 800	<b>782</b>	<b>772</b>	39.5	117.0	120.0	156.0	165.0	3.6	3.2	0.39	1.56	0.86	2.90	1.92
	180.975	47.625	48.006	38.100	6.4	3.2	288	438	2 100	2 800	<b>786</b>	<b>772</b>	39.5	123.0	120.0	156.0	165.0	6.4	3.2	0.39	1.56	0.86	2.88	1.92
	180.975	47.625	48.006	38.100	7.1	3.2	288	438	2 100	2 800	<b>787</b>	<b>772</b>	39.5	129.0	116.0	161.0	168.0	7.1	3.2	0.39	1.56	0.86	2.87	1.92
	190.500	47.625	49.212	34.925	3.6	3.2	303	483	1 900	2 600	<b>71412</b>	<b>71750</b>	40.9	117.0	131.0	167.0	177.0	3.6	3.2	0.42	1.44	0.79	3.96	1.72
<b>106.362</b>	165.100	36.512	36.512	26.988	3.6	3.2	195	325	2 200	2 900	<b>56418R</b>	<b>56650</b>	38.6	122.0	116.0	149.0	159.0	3.6	3.2	0.50	1.21	0.66	1.84	0.852
<b>107.950</b>	146.050	21.432	21.432	16.670	1.6	1.6	86.4	167	2 300	3 100	<b>L521949R</b>	<b>L521910</b>	26.2	116.0	114.0	136.0	141.0	1.6	1.6	0.39	1.53	0.84	0.665	0.325
	158.750	23.020	21.438	15.875	3.6	3.2	104	169	2 200	3 000	<b>37425</b>	<b>37625</b>	36.5	121.0	121.0	141.0	148.0	3.6	3.2	0.61	0.99	0.54	0.893	0.484
	159.987	34.925	34.925	26.988	3.6	3.2	184	319	2 200	2 900	<b>LM522546</b>	<b>LM522510</b>	32.9	122.0	116.0	146.0	154.0	3.6	3.2	0.40	1.50	0.82	1.64	0.784
	161.925	34.925	34.925	26.988	3.6	3.2	173	293	2 200	2 900	<b>48190</b>	<b>48120</b>	39.1	121.0	120.0	145.0	154.0	3.6	3.2	0.51	1.19	0.65	1.57	0.820
	165.100	36.512	36.512	26.988	3.6	3.2	195	325	2 200	2 900	<b>56425R</b>	<b>56650</b>	38.6	123.0	117.0	149.0	159.0	3.6	3.2	0.50	1.21	0.66	1.76	0.852
	168.275	36.512	36.512	26.988	3.6	3.2	195	325	2 200	2 900	<b>56425R</b>	<b>56662</b>	38.6	123.0	117.0	150.0	160.0	3.6	3.2	0.50	1.21	0.66	1.76	1.03
	190.500	47.625	49.212	34.925	3.6	3.2	303	483	1 900	2 600	<b>71425</b>	<b>71750</b>	40.9	121.0	131.0	167.0	177.0	3.6	3.2	0.42	1.44	0.79	3.76	1.72

[Note] 1) To the bearings with supplementary code "J" attached at the front of bearing number, tolerances shown in table 7-8 on page A66 are applied.

[Remark] Inch series tapered roller bearings with bore diameter larger than 100 mm are shown in catalog "large size ball & roller bearings".

Single-row tapered roller bearings  
inch series

$d$  (107.950) ~ 127.000 mm

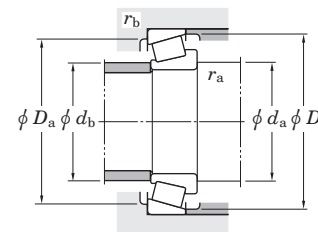
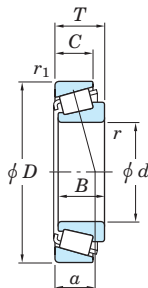

Boundary dimensions (mm)							Basic load ratings (kN)		Limiting speeds (min <sup>-1</sup> )		Bearing No. <sup>1)</sup>	Load center (mm) $a$	Mounting dimensions (mm)						Con- stant $e$	Axial load factors		(Refer.) Mass (kg)				
$d$	$D$	$T$	$B$	$C$	$r_{min.}$	$r_{1 min.}$	$C_r$	$C_{0r}$	Grease lub.	Oil lub.			Inner ring	Outer ring	$d_a$	$d_b$	$D_a$	$D_b$		$r_{a max.}$	$r_{b max.}$	$Y_1$	$Y_0$	Inner ring	Outer ring	
<b>107.950</b>	212.725	66.675	66.675	53.975	7.9	3.2	450	674	1 800	2 400	<b>936</b>	<b>932</b>	47.6	137.0	122.0	187.0	193.0	7.9	3.2	0.33	1.84	1.01	6.52	4.07		
	212.725	66.675	66.675	53.975	7.9	3.2	513	699	1 800	2 400			<b>HH224340</b>	<b>HH224310</b>	47.6	129.0	134.0	189.0	201.0	7.9	3.2	0.33	1.84	1.01	7.21	3.03
<b>109.538</b>	158.750	23.020	21.438	15.875	3.6	3.2	104	169	2 200	3 000	<b>37431</b>	<b>37625</b>	36.5	123.0	116.0	143.0	152.0	6.4	6.4	0.61	0.99	0.54	0.848	0.484		
<b>109.987</b>	159.987	34.925	34.925	26.988	7.9	3.2	184	319	2 200	2 900	<b>LM522548</b>	<b>LM522510</b>	32.9	131.0	121.0	146.0	153.0	7.9	3.2	0.40	1.50	0.82	1.52	0.784		
	159.987	34.925	34.925	26.988	3.6	3.2	184	319	2 200	2 900			<b>LM522549</b>	<b>LM522510</b>	32.9	123.0	121.0	146.0	153.0	3.6	3.2	0.40	1.50	0.82	1.55	0.784
<b>109.992</b>	177.800	41.275	41.275	30.162	3.6	3.2	234	380	2 000	2 700	<b>64433R</b>	<b>64700</b>	42.8	128.0	121.0	160.0	172.6	3.6	3.2	0.52	1.16	0.64	2.69	1.10		
<b>110.000</b>	165.000	35.000	35.000	26.500	3.0	2.5	195	325	2 200	2 900	<b>JM822049</b>	<b>JM822010</b>	38.1	121.0	121.0	148.0	157.0	3.0	2.5	0.50	1.21	0.66	1.64	0.826		
	180.000	47.000	46.000	38.000	3.0	2.5	306	487	2 000	2 700			<b>JHM522649</b>	<b>JHM522610</b>	40.6	121.0	125.0	160.0	171.0	3.0	2.5	0.41	1.48	0.81	3.08	1.49
<b>114.300</b>	177.800	41.275	41.275	30.162	3.6	3.2	234	380	2 000	2 700	<b>64450R</b>	<b>64700</b>	42.8	131.0	125.0	160.0	172.0	3.6	3.2	0.52	1.16	0.64	2.45	1.10		
	180.975	34.925	31.750	25.400	3.6	3.2	171	247	2 000	2 700			<b>68450</b>	<b>68712</b>	40.6	127.0	131.0	161.0	169.0	3.6	3.2	0.50	1.21	0.66	1.89	1.04
	190.500	47.625	49.212	34.925	3.6	3.2	303	483	1 900	2 600			<b>71450</b>	<b>71750</b>	40.9	127.0	131.0	167.0	177.0	3.6	3.2	0.42	1.44	0.79	3.33	1.72
	212.725	66.675	66.675	53.975	7.1	3.2	450	674	1 800	2 400			<b>938</b>	<b>932</b>	47.6	141.0	128.0	187.0	193.0	7.1	3.2	0.33	1.84	1.01	5.96	4.07
	212.725	66.675	66.675	53.975	7.1	3.2	513	699	1 800	2 400			<b>HH224346</b>	<b>HH224310</b>	47.6	134.0	134.0	189.0	201.0	7.1	3.2	0.33	1.84	1.01	6.64	3.03
	273.050	82.550	82.550	53.975	6.4	6.4	707	898	1 500	1 900			<b>HH926744</b>	<b>HH926710</b>	76.1	133.0	151.0	230.0	252.0	6.4	6.4	0.63	0.95	0.52	15.0	6.97
	212.725	66.675	66.675	53.975	7.1	3.2	513	699	1 800	2 400			<b>HH224349</b>	<b>HH224310</b>	47.6	135.0	134.0	189.0	201.0	7.1	3.2	0.33	1.84	1.01	6.58	3.03
<b>115.087</b>	190.500	47.625	49.212	34.925	3.6	3.2	303	483	1 900	2 600	<b>71453</b>	<b>71750</b>	40.9	133.0	126.0	171.0	181.0	3.6	3.2	0.42	1.44	0.79	3.28	1.72		
	190.500	47.625	49.212	34.925	7.9	3.2	303	483	1 900	2 600			<b>71455</b>	<b>71750</b>	40.9	136.0	131.0	167.0	177.0	7.9	3.2	0.42	1.44	0.79	3.25	1.72
<b>117.475</b>	180.975	34.925	31.750	25.400	3.6	3.2	171	247	2 000	2 700	<b>68462</b>	<b>68712</b>	40.6	130.0	131.0	161.0	169.0	3.6	3.2	0.50	1.21	0.66	1.75	1.04		
	180.975	34.925	31.750	25.400	7.9	3.2	171	247	2 000	2 700			<b>68463</b>	<b>68712</b>	40.6	141.0	125.0	163.0	172.0	7.9	3.2	0.50	1.21	0.66	1.61	1.05
<b>120.650</b>	190.500	46.038	46.038	34.925	3.6	1.6	313	512	1 900	2 500	<b>HM624749</b>	<b>HM624710</b>	41.6	146.0	132.0	174.0	184.0	3.6	1.6	0.43	1.41	0.77	3.20	1.44		
	254.000	77.788	82.550	61.912	9.5	6.4	717	1 050	1 500	2 000			<b>HH228340</b>	<b>HH228310</b>	54.3	158.0	142.0	223.0	234.0	9.5	6.4	0.32	1.87	1.03	12.6	6.00
<b>127.000</b>	254.000	77.788	82.550	61.912	9.5	6.4	717	1 050	1 500	2 000	<b>HH228349</b>	<b>HH228310</b>	54.3	164.0	148.0	223.0	234.0	9.5	6.4	0.32	1.87	1.03	11.8	6.00		

[Note] 1) To the bearings with supplementary code "J" attached at the front of bearing number, tolerances shown in table 7-8 on page A66 are applied.

[Remark] Inch series tapered roller bearings with bore diameter larger than 100 mm are shown in catalog "large size ball & roller bearings".

Single-row tapered roller bearings  
inch series

*d* 133.350 ~ 292.100 mm

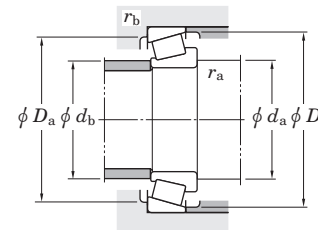
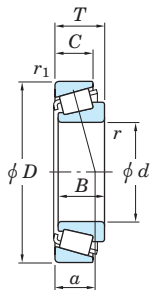

Boundary dimensions (mm)							Basic load ratings (kN)		Limiting speeds (min <sup>-1</sup> )		Bearing No. <sup>1)</sup>	Load center (mm) <i>a</i>	Mounting dimensions (mm)						Con-stant <i>e</i>	Axial load factors		(Refer.) Mass (kg)		
<i>d</i>	<i>D</i>	<i>T</i>	<i>B</i>	<i>C</i>	<i>r</i> <sub>min.</sub>	<i>r</i> <sub>1 min.</sub>	<i>C<sub>r</sub></i>	<i>C<sub>0r</sub></i>	Grease lub.	Oil lub.			Inner ring	Outer ring	<i>d<sub>a</sub></i>	<i>d<sub>b</sub></i>	<i>D<sub>a</sub></i>	<i>D<sub>b</sub></i>		<i>r<sub>a</sub></i> <sub>max.</sub>	<i>r<sub>b</sub></i> <sub>max.</sub>	<i>Y</i> <sub>1</sub>	<i>Y</i> <sub>0</sub>	Inner ring
<b>133.350</b>	177.008	25.400	26.195	20.638	1.6	1.6	141	278	1 900	2 500	<b>L327249</b>	<b>L327210</b>	29.1	142.0	145.0	164.0	169.0	1.6	1.6	0.35	1.72	0.95	1.14	0.543
<b>142.875</b>	200.025	41.275	39.688	34.130	7.9	3.3	246	491	1 700	2 200	<b>48684</b>	<b>48620</b>	38.4	166.0	151.0	185.0	193.0	7.9	3.3	0.34	1.78	0.98	2.43	1.38
	200.025	41.275	39.688	34.130	3.6	3.3	246	491	1 700	2 200	<b>48685</b>	<b>48620</b>	38.4	156.0	157.0	182.0	190.0	3.6	3.3	0.34	1.78	0.98	2.46	1.38
<b>170.000</b>	230.000	39.000	38.000	31.000	3.0	2.5	291	558	1 400	1 900	<b>JHM534149</b>	<b>JHM534110</b>	43.6	181.0	184.0	214.0	222.0	3.0	2.5	0.38	1.57	0.86	3.17	1.29
	240.000	46.000	44.500	37.000	3.0	2.5	353	666	1 400	1 800	<b>JM734449</b>	<b>JM734410</b>	50.6	181.0	184.0	220.0	231.0	3.0	2.5	0.44	1.37	0.75	4.31	2.00
<b>171.450</b>	222.250	25.400	24.608	19.050	1.6	1.6	157	299	1 400	1 900	<b>L435049</b>	<b>L435010</b>	36.0	181.0	179.0	211.0	215.0	1.6	1.6	0.38	1.60	0.88	1.63	0.697
<b>180.000</b>	250.000	47.000	45.000	37.000	3.0	2.5	365	705	1 300	1 700	<b>JM736149</b>	<b>JM736110</b>	55.2	191.0	193.0	230.0	242.0	3.0	2.5	0.48	1.25	0.69	4.47	2.10
<b>190.000</b>	260.000	46.000	44.000	36.500	3.0	2.5	369	723	1 200	1 700	<b>JM738249</b>	<b>JM738210</b>	56.0	201.0	203.0	240.0	251.0	3.0	2.5	0.48	1.26	0.69	4.71	2.18
<b>196.850</b>	254.000	28.575	27.783	21.433	1.6	1.6	188	387	1 200	1 600	<b>L540049</b>	<b>L540010</b>	43.1	206.0	214.0	238.0	243.0	1.6	1.6	0.40	1.51	0.83	2.34	1.02
<b>200.000</b>	300.000	65.000	62.000	51.000	3.6	2.5	617	1 140	1 100	1 500	<b>JHM840449</b>	<b>JHM840410</b>	72.1	213.0	218.0	270.0	288.0	3.6	2.5	0.52	1.15	0.63	9.97	5.13
<b>220.878</b>	317.500	47.625	52.388	36.513	3.2	3.2	488	928	970	1 300	<b>LM245833</b>	<b>LM245810</b>	50.5	234.0	253.0	296.0	304.0	3.2	3.2	0.33	1.80	0.99	9.56	2.78
<b>228.600</b>	358.775	71.438	71.438	53.975	3.6	3.2	773	1 590	840	1 100	<b>M249732</b>	<b>M249710</b>	64.4	242.0	279.0	330.0	342.0	3.6	3.2	0.33	1.80	0.99	20.1	6.44
<b>230.188</b>	317.500	47.625	52.388	36.513	3.2	3.2	488	928	970	1 300	<b>LM245846</b>	<b>LM245810</b>	50.5	242.0	238.0	309.0	312.0	3.2	3.2	0.33	1.80	0.99	8.25	2.78
<b>231.775</b>	317.500	47.625	52.388	36.513	3.2	3.2	488	928	970	1 300	<b>LM245848</b>	<b>LM245810</b>	50.5	244.0	240.0	309.0	312.0	3.2	3.2	0.33	1.80	0.99	8.02	2.78
	336.550	65.088	65.088	50.800	6.4	3.2	708	1 380	920	1 200	<b>M246942</b>	<b>M246910</b>	59.9	258.0	249.0	313.0	322.0	6.4	3.2	0.33	1.80	0.99	13.1	5.44
	358.775	71.438	71.438	53.975	6.4	3.2	773	1 590	920	1 200	<b>M249734</b>	<b>M249710</b>	64.4	258.0	253.0	335.0	343.0	6.4	3.2	0.33	1.80	0.99	19.9	6.44
<b>254.000</b>	358.775	71.438	71.438	53.975	3.6	3.2	773	1 590	840	1 100	<b>M249749</b>	<b>M249710</b>	64.4	268.0	279.0	330.0	342.0	3.6	3.2	0.33	1.80	0.99	14.8	6.44
<b>257.175</b>	342.900	57.150	57.150	44.450	6.4	3.2	612	1 280	870	1 200	<b>M349549</b>	<b>M349510</b>	60.1	276.0	276.0	320.0	330.0	6.4	3.2	0.35	1.73	0.95	9.27	3.99
<b>292.100</b>	374.650	47.625	47.625	34.925	3.6	3.2	468	971	760	1 000	<b>L555249</b>	<b>L555210</b>	64.7	306.0	309.0	351.0	360.0	3.6	3.2	0.40	1.49	0.82	7.97	3.53

[Note] 1) To the bearings with supplementary code "J" attached at the front of bearing number, tolerances shown in table 7-8 on page A66 are applied.

[Remark] Inch series tapered roller bearings with bore diameter larger than 100 mm are shown in catalog "large size ball & roller bearings".

Double-row tapered roller bearings

TDO type

d 25 ~ (60) mm

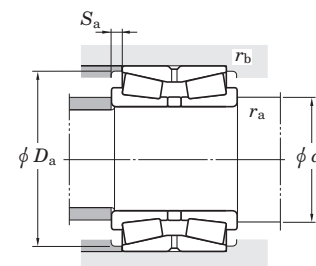
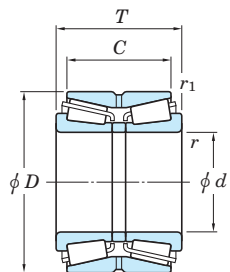

Boundary dimensions (mm)						Basic load ratings (kN)		Limiting speeds (min <sup>-1</sup> )		Bearing No.	Mounting dimensions (mm)					Constant e	Axial load factors			(Refer.) Mass (kg)
d	D	T	C	r min.	r <sub>1</sub> min.	C <sub>r</sub>	C <sub>0r</sub>	Grease lub.	Oil lub.		d <sub>a</sub> min.	D <sub>a</sub> min.	S <sub>a</sub> min.	r <sub>a</sub> max.	r <sub>b</sub> max.		Y <sub>2</sub>	Y <sub>3</sub>	Y <sub>0</sub>	
25	62	40	29.5	1.5	0.6	68.3	84.9	4 500	6 400	46T30305DJR/29.5	33.5	58.5	5	1.5	0.6	0.83	0.82	1.22	0.8	0.592
30	72	45	31.5	1.5	0.6	87.3	110	3 900	5 400	46T30306DJR/31.5	38.5	68	6.5	1.5	0.6	0.83	0.82	1.22	0.8	0.872
35	80	51	35.5	2	0.6	108	138	3 400	4 800	46T30307DJR/35.5	45	76.5	7.5	2	0.6	0.83	0.82	1.22	0.8	1.2
40	80	45	37.5	1.5	0.6	108	138	4 000	5 300	46T30208JR/37.5	48.5	75	3.5	1.5	0.6	0.37	1.8	2.68	1.76	0.954
	80	55	43.5	1.5	0.6	133	182	4 000	5 300	46T32208JR/43.5	48.5	75	5.5	1.5	0.6	0.37	1.8	2.68	1.76	1.19
	90	56	39.5	2	0.6	138	180	3 000	4 200	46T30308DJR/39.5	50	86.5	8	2	0.6	0.83	0.82	1.22	0.8	1.67
	90	56	45.5	2	0.6	155	202	3 600	4 900	46T30308JR/45.5	50	82	5	2	0.6	0.35	1.96	2.91	1.91	1.67
45	85	47	37.5	1.5	0.6	115	155	3 700	4 900	46T30209JR/37.5	53.5	80	4.5	1.5	0.6	0.4	1.67	2.48	1.63	1.1
	85	55	43.5	1.5	0.6	144	207	3 700	4 900	46T32209JR-1/43.5	53.5	81	5.5	1.5	0.6	0.4	1.67	2.48	1.63	1.31
	100	60	41.5	2	0.6	163	214	2 700	3 800	46T30309DJR/41.5	55	96	9	2	0.6	0.83	0.82	1.22	0.8	2.15
	100	60	49.5	2	0.6	193	256	3 300	4 300	46T30309JR/49.5	55	93	5	2	0.6	0.35	1.96	2.91	1.91	2.2
50	90	49	39.5	1.5	0.6	131	183	3 400	4 600	46T30210JR/39.5	58.5	85	4.5	1.5	0.6	0.42	1.61	2.39	1.57	1.22
	90	55	43.5	1.5	0.6	146	211	3 500	4 600	46T32210JR/43.5	58.5	85	5.5	1.5	0.6	0.42	1.61	2.39	1.57	1.39
	110	64	51.5	2	0.6	236	305	3 000	4 000	46T30310JR/51.5	62	102	6	2	0.6	0.35	1.96	2.91	1.91	2.68
	110	73	52.5	2	0.6	198	266	2 500	3 500	46T30310DJR/52.5	62	105	10	2	0.6	0.83	0.82	1.22	0.8	3.11
	110	90	71.5	2	0.6	302	440	3 000	4 000	46T32310JR/71.5	62	102	9	2	0.6	0.35	1.96	2.91	1.91	3.95
55	100	51	41.5	2	0.6	162	226	3 100	4 100	46T30211JR/41.5	65	94	4.5	2	0.6	0.4	1.67	2.48	1.63	1.6
	100	60	48.5	2	0.6	184	266	3 100	4 100	46T32211JR-1/48.5	65	95	5.5	2	0.6	0.4	1.67	2.48	1.63	1.87
	120	70	49	2	0.6	221	297	2 300	3 200	46T30311DJR/49	67	113	10.5	2	0.6	0.83	0.82	1.22	0.8	3.54
	120	70	57	2	0.6	256	341	2 700	3 600	46T30311JR/57	67	111	6.5	2	0.6	0.35	1.96	2.91	1.91	3.57
	120	97	76	2	0.6	343	500	2 700	3 600	46T32311JR/76	67	111	10.5	2	0.6	0.35	1.96	2.91	1.91	4.98
60	110	53	43.5	2	0.6	182	254	2 800	3 800	46T30212JR/43.5	70	103	4.5	2	0.6	0.4	1.67	2.48	1.63	2.04
	110	66	54.5	2	0.6	226	334	2 800	3 800	46T32212JR/54.5	70	104	5.5	2	0.6	0.4	1.67	2.48	1.63	—
	130	74	51	2.5	1	262	359	2 100	2 900	46T30312DJR/51	74	124	11.5	2.5	1	0.83	0.82	1.22	0.8	4.45
	130	74	59	2.5	1	297	401	2 500	3 300	46T30312JR/59	74	120	7.5	2.5	1	0.35	1.96	2.91	1.91	4.46

[Remark] Bearings not shown above (e.g. inch series) are shown in catalog "large size ball & roller bearings".



Double-row tapered roller bearings

TDO type

d (60) ~ (90) mm

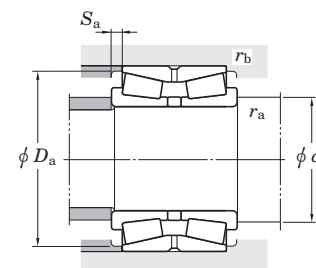
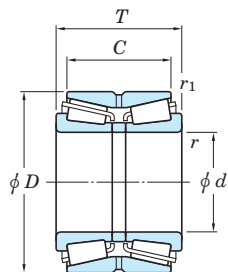

Boundary dimensions (mm)						Basic load ratings (kN)		Limiting speeds (min <sup>-1</sup> )		Bearing No.	Mounting dimensions (mm)					Constant e	Axial load factors			(Refer.) Mass (kg)
d	D	T	C	r min.	r1 min.	Cr	C0r	Grease lub.	Oil lub.		da min.	Da min.	Sa min.	ra max.	rb max.		Y2	Y3	Y0	
60	130	104	81	2.5	1	419	629	2 500	3 300	<b>46T32312JR/81</b>	74	120	11.5	2.5	1	0.35	1.96	2.91	1.91	6.45
65	120	56	46.5	2	0.6	220	311	2 600	3 400	<b>46T30213JR/46.5</b>	75	113	4.5	2	0.6	0.4	1.67	2.48	1.63	—
	120	73	61.5	2	0.6	270	406	2 600	3 400	<b>46T32213JR/61.5</b>	75	115	5.5	2	0.6	0.4	1.67	2.48	1.63	3.4
	140	79	53	2.5	1	302	417	1 900	2 700	<b>46T30313DJR/53</b>	79	133	13	2.5	1	0.83	0.82	1.22	0.8	5.3
	140	79	63	2.5	1	349	478	2 300	3 000	<b>46T30313JR/63</b>	79	130	8	2.5	1	0.35	1.96	2.91	1.91	5.51
	140	108	84	2.5	1	474	714	2 300	3 100	<b>46T32313JR/84</b>	79	130	12	2.5	1	0.35	1.96	2.91	1.91	7.71
70	125	59	48.5	2	0.6	236	346	2 400	3 300	<b>46T30214JR/48.5</b>	80	118	5	2	0.6	0.42	1.61	2.39	1.57	—
	125	74	61.5	2	0.6	290	450	2 400	3 300	<b>46T32214JR/61.5</b>	80	119	6	2	0.6	0.42	1.61	2.39	1.57	3.7
	150	83	57	2.5	1	338	470	1 800	2 500	<b>46T30314DJR/57</b>	84	142	13	2.5	1	0.83	0.82	1.22	0.8	6.48
	150	83	67	2.5	1	394	546	2 100	2 800	<b>46T30314JR/67</b>	84	140	8	2.5	1	0.35	1.96	2.91	1.91	6.65
	150	116	92	2.5	1	543	829	2 200	2 900	<b>46T32314JR/92</b>	84	140	12	2.5	1	0.35	1.96	2.91	1.91	9.46
75	115	30	26	1.5	0.6	71.7	105	2 500	3 300	<b>46215</b>	83.5	106.5	2	1.5	0.6	0.32	2.12	3.15	2.07	0.994
	115	38	30	1.5	0.6	122	207	2 500	3 300	<b>46215A</b>	83.5	107.4	4	1.5	0.6	0.32	2.12	3.15	2.07	1.32
	130	62	51.5	2	0.6	244	362	2 300	3 100	<b>46T30215JR/51.5</b>	85	124	5	2	0.6	0.44	1.55	2.31	1.52	3.12
	130	74	61.5	2	0.6	298	469	2 300	3 100	<b>46T32215JR/61.5</b>	85	125	6	2	0.6	0.44	1.55	2.31	1.52	3.85
	160	87	69	2.5	1	445	621	2 000	2 600	<b>46T30315JR/69</b>	89	149	9	2.5	1	0.35	1.96	2.91	1.91	7.8
	160	125	99	2.5	1	622	963	2 000	2 700	<b>46T32315JR/99</b>	89	149	13	2.5	1	0.35	1.96	2.91	1.91	11.5
	160	125	99	2.5	1	622	963	2 000	2 700	<b>46T32315JR/99</b>	89	149	13	2.5	1	0.35	1.96	2.91	1.91	11.5
80	125	34	30	1.5	0.6	108	155	2 300	3 100	<b>46216</b>	88.5	116.9	2	1.5	0.6	0.35	1.95	2.90	1.91	1.38
	140	64	51.5	2	0.6	277	405	2 200	2 900	<b>46T30216JR/51.5</b>	92	132	6	2	0.6	0.42	1.61	2.39	1.57	3.76
	140	78	63.5	2	0.6	347	542	2 200	2 900	<b>46T32216JR/63.5</b>	92	134	7	2	0.6	0.42	1.61	2.39	1.57	4.71
	170	92	73	2.5	1	504	711	1 800	2 500	<b>46T30316JR/73</b>	94	159	9.5	2.5	1	0.35	1.96	2.91	1.91	9.44
85	150	70	57	2	0.6	313	463	2 000	2 700	<b>46T30217JR/57</b>	97	141	6.5	2	0.6	0.42	1.61	2.39	1.57	4.79
	150	86	69	2	0.6	398	630	2 000	2 700	<b>46T32217JR/69</b>	97	142	8.5	2	0.6	0.42	1.61	2.39	1.57	6.05
	180	98	77	3	1	543	768	1 700	2 300	<b>46T30317JR/77</b>	103	167	10.5	3	1	0.35	1.96	2.91	1.91	11
	180	137	108	3	1	752	1 170	1 800	2 400	<b>46T32317JR/108</b>	103	167	14.5	3	1	0.35	1.96	2.91	1.91	16
90	140	37	33	2	0.6	136	199	2 100	2 800	<b>46218</b>	100	130.6	2	2	0.6	0.35	1.95	2.90	1.91	1.89

[Remark] Bearings not shown above (e.g. inch series) are shown in catalog "large size ball & roller bearings".

Double-row tapered roller bearings

TDO type

$d$  (90) ~ 110 mm

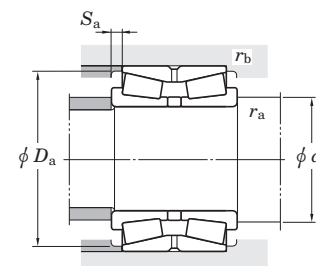
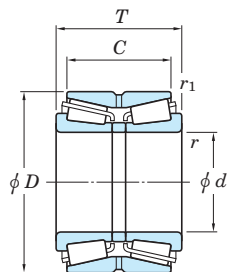

Boundary dimensions (mm)						Basic load ratings (kN)		Limiting speeds (min <sup>-1</sup> )		Bearing No.	Mounting dimensions (mm)					Constant $e$	Axial load factors			(Refer.) Mass (kg)	
$d$	$D$	$T$	$C$	$r_{min.}$	$r_{1 min.}$	$C_r$	$C_{0r}$	Grease lub.	Oil lub.		$d_a min.$	$D_a min.$	$S_a min.$	$r_a max.$	$r_b max.$		$Y_2$	$Y_3$	$Y_0$		
<b>90</b>	140	46	37	2	0.6	157	266	2 000	2 700	<b>46218A</b>	100	129.9	4.5	2	0.6	0.32	2.12	3.15	2.07	2.37	
	160	74	61	2	0.6	350	522	1 900	2 500		<b>46T30218JR/61</b>	102	150	6.5	2	0.6	0.42	1.61	2.39	1.57	5.85
	160	94	77	2	0.6	451	724	1 900	2 500		<b>46T32218JR/77</b>	102	152	8.5	2	0.6	0.42	1.61	2.39	1.57	7.53
	190	102	81	3	1	592	841	1 600	2 200		<b>46T30318JR/81</b>	108	177	10.5	3	1	0.35	1.96	2.91	1.91	13
	190	144	115	3	1	791	1 230	1 700	2 200		<b>46T32318JR/115</b>	108	177	14.5	3	1	0.35	1.96	2.91	1.91	18.6
<b>95</b>	170	78	63	2.5	1	396	598	1 800	2 400	<b>46T30219JR/63</b>	109	159	7.5	2.5	1	0.42	1.61	2.39	1.57	7.01	
	170	100	83	2.5	1	533	877	1 800	2 400		<b>46T32219JR/83</b>	109	161	8.5	2.5	1	0.42	1.61	2.39	1.57	9.25
	200	108	85	3	1	638	909	1 600	2 100		<b>46T30319JR/85</b>	113	186	11.5	3	1	0.35	1.96	2.91	1.91	14.8
	200	151	118	3	1	886	1 390	1 600	2 100		<b>46T32319JR/118</b>	113	186	16.5	3	1	0.35	1.96	2.91	1.91	21.4
<b>100</b>	150	46	37	2	0.6	180	293	1 900	2 500	<b>46220A</b>	110	142	4.5	2	0.6	0.35	1.95	2.90	1.91	2.53	
	165	52	46	2.5	0.6	198	305	1 700	2 300		<b>46320</b>	112	154	3	2	0.6	0.35	1.95	2.90	1.91	4.03
	165	65	52	2.5	0.6	265	443	1 800	2 300		<b>46320A</b>	112	153	6.5	2	0.6	0.35	1.95	2.90	1.91	4.97
	180	83	67	2.5	1	443	676	1 700	2 200		<b>46T30220JR/67</b>	114	168	8	2.5	1	0.42	1.61	2.39	1.57	8.33
	180	107	87	2.5	1	596	990	1 700	2 200		<b>46T32220JR/87</b>	114	171	10	2.5	1	0.42	1.61	2.39	1.57	11.1
	215	112	87	3	1	724	1 040	1 500	1 900		<b>46T30320JR/87</b>	118	200	12.5	3	1	0.35	1.96	2.91	1.91	18.1
	215	162	127	3	1	993	1 570	1 500	2 000		<b>46T32320JR/127</b>	118	200	17.5	3	1	0.35	1.96	2.91	1.91	27.2
<b>105</b>	190	88	70	2.5	1	494	761	1 600	2 100	<b>46T30221JR/70</b>	119	178	9	2.5	1	0.42	1.61	2.39	1.57	9.87	
	190	115	95	2.5	1	672	1 130	1 600	2 100		<b>46T32221JR/95</b>	119	180	10	2.5	1	0.42	1.61	2.39	1.57	13.5
	225	116	91	3	1	796	1 160	1 400	1 800		<b>46T30321JR/91</b>	123	209	12.5	3	1	0.35	1.96	2.91	1.91	20.7
	225	170	133	3	1	1 090	1 730	1 400	1 900		<b>46T32321JR/133</b>	123	209	18.5	3	1	0.35	1.96	2.91	1.91	30.9
<b>110</b>	170	45	40	2.5	0.6	175	304	1 700	2 200	<b>46222</b>	122	158	2.5	2	0.6	0.35	1.95	2.90	1.91	3.58	
	180	56	50	2.5	0.6	245	388	1 600	2 100		<b>46322</b>	122	168	3	2	0.6	0.35	1.95	2.90	1.91	5.13
	180	70	56	2.5	0.6	324	533	1 600	2 100		<b>46322A</b>	122	168	7	2	0.6	0.35	1.92	2.86	1.88	6.43
	200	92	74	2.5	1	556	868	1 500	2 000		<b>46T30222JR/74</b>	124	188	9	2.5	1	0.42	1.61	2.39	1.57	11.6
	200	121	101	2.5	1	750	1 280	1 500	2 000		<b>46T32222JR/101</b>	124	190	10	2.5	1	0.42	1.61	2.39	1.57	15.9
	240	118	93	3	1	824	1 180	1 300	1 700		<b>46T30322JR/93</b>	128	222	12.5	3	1	0.35	1.96	2.91	1.91	23.8
	240	181	142	3	1	1 190	1 890	1 300	1 700		<b>46T32322JR/142</b>	128	222	19.5	3	1	0.35	1.96	2.91	1.91	37.3

[Remark] Bearings not shown above (e.g. inch series) are shown in catalog "large size ball & roller bearings".

Double-row tapered roller bearings

TDO type

d 120 ~ (150) mm

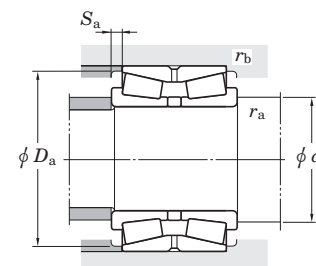
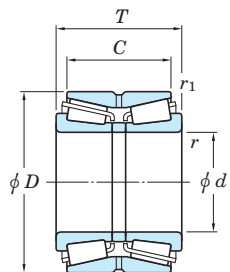

Boundary dimensions (mm)						Basic load ratings (kN)		Limiting speeds (min <sup>-1</sup> )		Bearing No.	Mounting dimensions (mm)					Constant e	Axial load factors			(Refer.) Mass (kg)
d	D	T	C	r min.	r1 min.	Cr	C0r	Grease lub.	Oil lub.		da min.	Da min.	Sa min.	ra max.	rb max.		Y2	Y3	Y0	
120	180	46	41	2.5	0.6	185	317	1 500	2 000	46224 46224A 46324 46324A 46324AS 46T30224JR/78 46T32224JR/109 46T30324JR/101 46T32324JR/145	132	170	2.5	2	0.6	0.35	1.95	2.90	1.91	3.81
	180	58	46	2.5	0.6	247	460	1 500	2 100		132	169	6	2	0.6	0.35	1.95	2.90	1.91	4.66
	200	62	55	2.5	0.6	292	470	1 400	1 900		132	184	3.5	2	0.6	0.35	1.95	2.90	1.91	7.28
	200	78	62	2.5	0.6	387	672	1 400	1 900		132	185	8	2	0.6	0.35	1.95	2.90	1.91	9.14
	200	100	84	2.5	0.6	533	1 010	1 400	1 900		132	190	8	2	0.6	0.35	1.95	2.90	1.91	12.0
	215	97	78	2.5	1	595	945	1 400	1 800		134	203	9.5	2.5	1	0.44	1.55	2.31	1.52	13.9
	215	132	109	2.5	1	806	1 380	1 400	1 900		134	204	11.5	2.5	1	0.44	1.55	2.31	1.52	19.8
	260	128	101	3	1	976	1 430	1 200	1 600		138	239	13.5	3	1	0.35	1.96	2.91	1.91	30.6
	260	188	145	4	1.5	1 370	2 210	1 200	1 600		142	239	21.5	4	1.5	0.35	1.96	2.91	1.91	45.9
130	200	52	46	2.5	0.6	239	425	1 400	1 800	46226 46226A 46326 46326A 46T30226JR/78.5 46T32226JR/117.5 46T30326JR/107.5	142	187	3	2	0.6	0.35	1.95	2.90	1.91	5.57
	200	65	52	2.5	0.6	319	618	1 400	1 900		142	185	6.5	2	0.6	0.35	1.95	2.90	1.91	7.06
	210	64	57	2.5	0.6	322	535	1 400	1 800		142	196	3.5	2	0.6	0.36	1.87	2.79	1.83	7.81
	210	80	64	2.5	0.6	424	723	1 300	1 800		142	198	8	2	0.6	0.36	1.87	2.79	1.83	9.57
	230	98	78.5	3	1	646	1 020	1 300	1 700		148	218	9.5	3	1	0.44	1.55	2.31	1.52	15.7
	230	145	117.5	3	1	949	1 660	1 300	1 700		148	219	14	3	1	0.44	1.55	2.31	1.52	24.1
	280	137	107.5	4	1.5	1 130	1 670	1 100	1 400		152	255	15	4	1.5	0.35	1.96	2.91	1.91	38.1
140	210	53	47	2.5	0.6	239	404	1 300	1 800	46228 46228A 46328 46328A 46T30228JR/82.5 46T32228JR/125.5 46T30328JR/115.5	152	196	3	2	0.6	0.33	2.03	3.02	1.98	5.85
	210	66	53	2.5	0.6	360	639	1 300	1 800		152	199	6.5	2	0.6	0.47	1.43	2.12	1.40	7.18
	225	68	61	3	1	360	564	1 200	1 700		154	210	3.5	2.5	1	0.35	1.95	2.90	1.91	9.56
	225	85	68	3	1	475	836	1 200	1 700		154	212	8	2.5	1	0.35	1.95	2.90	1.91	11.8
	250	102	82.5	3	1	720	1 140	1 200	1 500		158	237	9.5	3	1	0.44	1.55	2.31	1.52	19.7
	250	153	125.5	3	1	1 090	1 920	1 200	1 600		158	238	14	3	1	0.44	1.55	2.31	1.52	30.2
	300	145	115.5	4	1.5	1 280	1 920	1 000	1 300		162	273	15	4	1.5	0.35	1.96	2.91	1.91	46.6
	150	225	56	50	3	1	278	476	1 200		1 600	46230 46230A 46330 46330A 46T30230JR/87	164	213	3	2.5	1	0.33	2.03	3.02
225		70	56	3	1	377	703	1 200	1 600	164	213		7	2.5	1	0.33	2.03	3.02	1.98	8.82
250		80	71	3	1	467	786	1 100	1 500	164	233		4.5	2.5	1	0.35	1.95	2.90	1.91	14.6
250		100	80	3	1	595	1 070	1 100	1 500	164	234		10	2.5	1	0.35	1.95	2.90	1.91	17.6
270		109	87	3	1	827	1 330	1 100	1 400	168	255		11	3	1	0.44	1.55	2.31	1.52	24.6

[Remark] Bearings not shown above (e.g. inch series) are shown in catalog "large size ball & roller bearings".

Double-row tapered roller bearings

TDO type

d (150) ~ (200) mm

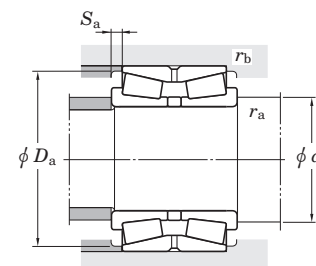
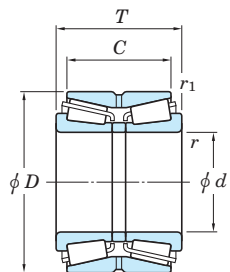

Boundary dimensions (mm)						Basic load ratings (kN)		Limiting speeds (min <sup>-1</sup> )		Bearing No.	Mounting dimensions (mm)					Constant e	Axial load factors			(Refer.) Mass (kg)
d	D	T	C	r min.	r1 min.	Cr	C0r	Grease lub.	Oil lub.		da min.	Da min.	Sa min.	ra max.	rb max.		Y2	Y3	Y0	
150	270	164	130	3	1	1 210	2 130	1 100	1 400	46T32230JR/130 46T30330JR/120	168	254	17	3	1	0.44	1.55	2.31	1.52	38
	320	154	120	4	1.5	1 430	2 160	930	1 200		172	292	17	4	1.5	0.35	1.96	2.91	1.91	56
160	240	60	53	3	1	324	565	1 100	1 500	46232 46232A 46332 46332A 46T30232JR/91 46T32232JR/144	174	228	3.5	2.5	1	0.33	2.03	3.02	1.98	8.71
	240	75	60	3	1	406	756	1 100	1 500		174	226	7.5	2.5	1	0.33	2.03	3.02	1.98	10.6
	270	86	76	3	1	592	950	1 000	1 400		174	252	5	2.5	1	0.35	1.95	2.90	1.91	18.8
	270	108	86	3	1	727	1 270	1 000	1 400		174	252	11	2.5	1	0.35	1.95	2.90	1.91	23.1
	290	115	91	3	1	929	1 500	980	1 300		178	269	12	3	1	0.44	1.55	2.31	1.52	29.9
	290	178	144	3	1	1 360	2 420	1 000	1 300		178	274	17	3	1	0.44	1.55	2.31	1.52	47.6
170	260	67	60	3	1	382	642	1 000	1 400	46234 46234A 46334 46334A 46T30234JR/97 46T32234JR/152	184	243	3.5	2.5	1	0.33	2.03	3.02	1.98	11.4
	260	84	67	3	1	502	969	1 000	1 400		184	244	8.5	2.5	1	0.33	2.03	3.02	1.98	14.7
	280	88	78	3	1	599	1 050	970	1 300		184	263	5	2.5	1	0.33	2.06	3.06	2.01	19.8
	280	110	88	3	1	776	1 390	980	1 300		184	260	11	2.5	1	0.33	2.06	3.06	2.01	24.7
	310	125	97	4	1.5	1 060	1 730	900	1 200		192	288	14	4	1.5	0.44	1.55	2.31	1.52	37.5
	310	192	152	4	1.5	1 540	2 760	910	1 200		192	294	20	4	1.5	0.44	1.55	2.31	1.52	58.8
180	280	74	66	3	1	464	801	950	1 300	46236 46236A 46336 46336A 46T30236JR/99 46T32236JR/152	194	263	4	2.5	1	0.33	2.03	3.02	1.98	15.5
	280	93	74	3	1	584	1 080	960	1 300		194	261	9.5	2.5	1	0.33	2.03	3.02	1.98	19.0
	300	96	85	4	1.5	693	1 240	910	1 200		198	277	5.5	3	1.5	0.33	2.06	3.06	2.01	25.8
	300	120	96	4	1.5	894	1 630	900	1 200		198	279	12	3	1.5	0.33	2.06	3.06	2.01	31.3
	320	127	99	4	1.5	1 060	1 740	860	1 200		202	297	14	4	1.5	0.45	1.5	2.23	1.47	40.1
	320	192	152	4	1.5	1 640	3 030	880	1 200		202	303	20	4	1.5	0.45	1.5	2.23	1.47	62.5
190	290	75	67	3	1	487	866	910	1 200	46238 46238A 46338 46338A 46T30238JR/105 46T32238JR/160	204	272	4	2.5	1	0.32	2.12	3.15	2.07	16.5
	290	94	75	3	1	632	1 170	900	1 200		204	274	9.5	2.5	1	0.33	2.03	3.02	1.98	20.0
	320	104	92	4	1.5	808	1 450	830	1 100		208	298	6	3	1.5	0.35	1.95	2.90	1.91	31.9
	320	130	104	4	1.5	1 020	1 860	840	1 100		208	298	13	3	1.5	0.35	1.95	2.90	1.91	39.0
	340	133	105	4	1.5	1 250	2 060	800	1 100		212	318	14	4	1.5	0.44	1.55	2.31	1.52	47.8
	340	204	160	4	1.5	1 870	3 480	810	1 100		212	323	22	4	1.5	0.44	1.55	2.31	1.52	75.1
200	310	82	73	3	1	572	1 040	850	1 100	46240	214	288	4.5	2.5	1	0.32	2.12	3.15	2.07	21.4

[Remark] Bearings not shown above (e.g. inch series) are shown in catalog "large size ball & roller bearings".

Double-row tapered roller bearings

TDO type

$d$  (200) ~ (300) mm

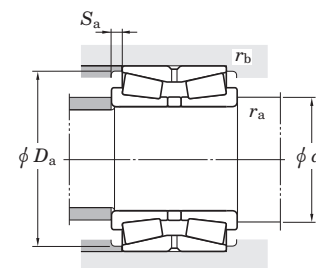
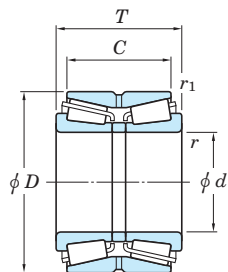

Boundary dimensions (mm)						Basic load ratings (kN)		Limiting speeds (min <sup>-1</sup> )		Bearing No.	Mounting dimensions (mm)					Constant $e$	Axial load factors			(Refer.) Mass (kg)	
$d$	$D$	$T$	$C$	$r_{min.}$	$r_{1 min.}$	$C_r$	$C_{0r}$	Grease lub.	Oil lub.		$d_a$ min.	$D_a$ min.	$S_a$ min.	$r_a$ max.	$r_b$ max.		$Y_2$	$Y_3$	$Y_0$		
<b>200</b>	310	103	82	3	1	713	1 380	840	1 100	<b>46240A</b>	214	289	10.5	2.5	1	0.32	2.12	3.15	2.07	26.3	
	340	112	100	4	1.5	939	1 580	780	1 000		<b>46340</b>	218	316	6	3	1.5	0.35	1.95	2.90	1.91	39.6
	340	140	112	4	1.5	1 110	2 040	770	1 000		<b>46340A</b>	218	319	14	3	1.5	0.35	1.95	2.90	1.91	48.2
	360	142	110	4	1.5	1 360	2 240	750	1 000		<b>46T30240JR/110</b>	222	336	16	4	1.5	0.44	1.55	2.31	1.52	56.5
	360	218	174	4	1.5	2 130	3 760	770	1 000		<b>46T32240JR/174</b>	222	340	22	4	1.5	0.41	1.66	2.47	1.62	88.2
<b>220</b>	340	90	80	4	1.5	677	1 240	750	990	<b>46244</b>	238	319	5	3	1.5	0.32	2.12	3.15	2.07	27.8	
	340	113	90	4	1.5	832	1 620	750	1 000		<b>46244A</b>	238	318	11.5	3	1.5	0.32	2.12	3.15	2.07	34.2
	370	120	107	5	1.5	1 070	1 810	700	930		<b>46344</b>	242	346	6.5	4	1.5	0.35	1.95	2.90	1.91	49.1
	370	150	120	5	1.5	1 330	2 470	710	940		<b>46344A</b>	242	343	15	4	1.5	0.35	1.95	2.90	1.91	60.1
	400	150	114	4	1.5	1 730	2 880	660	890		<b>46T30244JR/114</b>	242	371	18	4	1.5	0.42	1.61	2.39	1.57	75.8
<b>240</b>	360	92	82	4	1.5	768	1 430	690	920	<b>46248</b>	258	338	5	3	1.5	0.32	2.12	3.15	2.07	29.6	
	360	115	92	4	1.5	990	1 980	690	920		<b>46248A</b>	258	341	11.5	3	1.5	0.32	2.12	3.15	2.07	36.9
	400	128	114	5	1.5	1 190	2 180	630	840		<b>46348</b>	262	377	7	4	1.5	0.35	1.95	2.90	1.91	59.0
	400	160	128	5	1.5	1 540	3 060	630	850		<b>46348A</b>	262	373	16	4	1.5	0.35	1.95	2.90	1.91	76.2
<b>260</b>	400	104	92	5	1.5	935	1 830	610	820	<b>46252</b>	282	373	6	4	1.5	0.33	2.03	3.02	1.98	44.6	
	400	130	104	5	1.5	1 210	2 480	610	810		<b>46252A</b>	282	376	13	4	1.5	0.32	2.12	3.15	2.07	54.8
	440	144	128	5	1.5	1 510	2 880	560	750		<b>46352</b>	282	410	8	4	1.5	0.35	1.95	2.90	1.91	83.8
	440	180	144	5	1.5	2 010	3 960	570	760		<b>46352A</b>	282	409	18	4	1.5	0.35	1.95	2.90	1.91	105
<b>280</b>	420	106	94	5	1.5	1 010	1 970	570	760	<b>46256</b>	302	395	6	4	1.5	0.33	2.03	3.02	1.98	46.9	
	420	133	106	5	1.5	1 250	2 610	570	760		<b>46256A</b>	302	394	13.5	4	1.5	0.33	2.03	3.02	1.98	58.9
	460	146	130	6	2	1 550	2 930	530	700		<b>46356</b>	308	430	8	5	2	0.35	1.95	2.90	1.91	90.0
	460	183	146	6	2	2 040	3 940	520	690		<b>46356A</b>	308	434	18.5	5	2	0.35	1.95	2.90	1.91	111
<b>300</b>	460	118	105	5	1.5	1 290	2 400	500	670	<b>46260</b>	322	436	6.5	4	1.5	0.32	2.12	3.15	2.07	64.6	
	460	148	118	5	1.5	1 630	3 230	510	680		<b>46260A</b>	322	433	15	4	1.5	0.32	2.12	3.15	2.07	80.2
	500	160	142	6	2	1 980	3 540	470	620		<b>46360</b>	328	469	9	5	2	0.35	1.95	2.90	1.91	116
	500	200	160	6	2	2 270	4 630	470	630		<b>46360A</b>	328	466	20	5	2	0.35	1.95	2.90	1.91	144

[Remark] Bearings not shown above (e.g. inch series) are shown in catalog "large size ball & roller bearings".

Double-row tapered roller bearings

TDO type

$d$  (300) ~ 420 mm

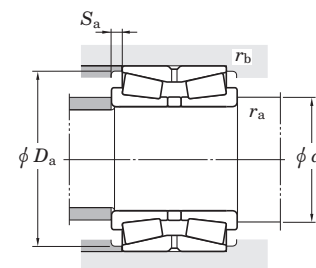
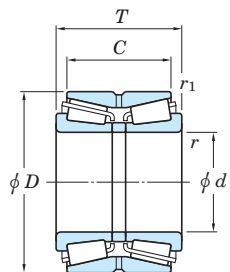

Boundary dimensions (mm)						Basic load ratings (kN)		Limiting speeds (min <sup>-1</sup> )		Bearing No.	Mounting dimensions (mm)					Constant $e$	Axial load factors			(Refer.) Mass (kg)
$d$	$D$	$T$	$C$	$r_{min.}$	$r_{1 min.}$	$C_r$	$C_{0r}$	Grease lub.	Oil lub.		$d_a$ min.	$D_a$ min.	$S_a$ min.	$r_a$ max.	$r_b$ max.		$Y_2$	$Y_3$	$Y_0$	
<b>300</b>	500	200	160	6	1.5	2 500	4 650	—	—	<b>46360D</b>	328	475	20	5	1.5	0.40	1.68	2.50	1.64	139
<b>320</b>	480	121	108	5	1.5	1 430	2 700	480	640	<b>46264</b> <b>46264A</b> <b>46364</b> <b>46364A</b>	342	452	6.5	4	1.5	0.32	2.12	3.15	2.07	71.6
	480	151	121	5	1.5	1 650	3 410	470	630		342	454	15	4	1.5	0.32	2.12	3.15	2.07	87.7
	540	176	157	6	2	2 440	4 570	420	560		348	502	9.5	5	2	0.35	1.95	2.90	1.91	154
	540	220	176	6	2	2 610	5 390	430	570		348	497	22	5	2	0.35	1.95	2.90	1.91	190
<b>340</b>	520	133	118	6	2	1 550	3 070	420	570	<b>46268</b> <b>46268A</b> <b>46368</b> <b>46368A</b>	368	489	7.5	5	2	0.32	2.12	3.15	2.07	95.3
	520	165	133	6	2	1 930	4 060	420	560		368	491	16	5	2	0.32	2.12	3.15	2.07	117
	580	190	169	6	2	2 540	4 620	380	510		368	539	10.5	5	2	0.35	1.95	2.90	1.91	198
	580	238	190	6	2	3 160	6 340	370	500		368	543	24	5	2	0.35	1.95	2.90	1.91	244
<b>360</b>	540	134	120	6	2	1 660	3 290	400	530	<b>46272</b> <b>46272A</b> <b>46372</b> <b>46372A</b>	388	510	7	5	2	0.32	2.12	3.15	2.07	93.0
	540	169	134	6	2	2 020	4 230	390	530		388	512	17.5	5	2	0.32	2.12	3.15	2.07	124
	600	192	171	6	2	2 680	4 880	360	480		388	557	10.5	5	2	0.35	1.95	2.90	1.91	206
	600	240	192	6	2	3 660	7 230	360	480		388	568	24	5	2	0.39	1.74	2.59	1.70	254
<b>380</b>	560	135	122	6	2	1 740	3 560	370	500	<b>46276</b> <b>46276A</b> <b>46376</b> <b>46376A</b>	408	530	6.5	5	2	0.32	2.12	3.15	2.07	100
	560	171	135	6	2	2 240	4 670	380	500		408	531	18	5	2	0.39	1.74	2.59	1.70	129
	620	194	173	6	2	2 870	5 220	340	450		408	582	10.5	5	2	0.39	1.74	2.59	1.70	215
	620	243	194	6	2	3 490	7 360	330	440		408	587	24.5	5	2	0.35	1.95	2.90	1.91	265
<b>400</b>	600	148	132	6	2	1 870	3 720	340	460	<b>46280</b> <b>46280A</b> <b>46380</b> <b>46380A</b>	428	560	8	5	2	0.32	2.12	3.15	2.07	135
	600	185	148	6	2	2 420	5 150	340	460		428	563	18.5	5	2	0.32	2.12	3.15	2.07	167
	650	200	178	6	3	2 980	5 920	320	420		428	605	11	5	2.5	0.35	1.95	2.90	1.91	243
	650	250	200	6	3	4 060	8 850	310	420		428	610	25	5	2.5	0.35	1.95	2.90	1.91	306
<b>420</b>	620	150	134	6	2	2 010	4 130	320	420	<b>46284</b> <b>46284A</b> <b>46384</b> <b>46384A</b>	448	590	8	5	2	0.33	2.03	3.02	1.98	142
	620	188	150	6	2	2 700	5 660	320	430		448	589	19	5	2	0.39	1.74	2.59	1.70	176
	700	224	200	6	3	3 700	6 880	290	380		448	656	12	5	2.5	0.39	1.74	2.59	1.70	325
	700	280	224	6	3	4 810	9 620	290	380		448	659	28	5	2.5	0.39	1.74	2.59	1.70	400

[Remark] Bearings not shown above (e.g. inch series) are shown in catalog "large size ball & roller bearings".

Double-row tapered roller bearings

TDO type

d 440 ~ 500 mm

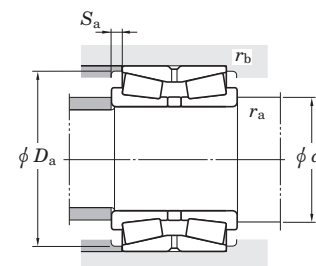
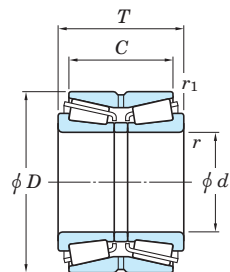

d	Boundary dimensions (mm)					Basic load ratings (kN)		Limiting speeds (min <sup>-1</sup> )		Bearing No.	Mounting dimensions (mm)					Constant e	Axial load factors			(Refer.) Mass (kg)
	D	T	C	r min.	r1 min.	Cr	C0r	Grease lub.	Oil lub.		da min.	Da min.	Sa min.	ra max.	rb max.		Y2	Y3	Y0	
440	650	157	140	6	3	2 260	4 430	300	390	46288 46288A 46388 46388A	468	622	8.5	5	2.5	0.33	2.03	3.02	1.98	156
	650	196	157	6	3	3 000	6 370	300	400		468	620	19.5	5	2.5	0.39	1.74	2.59	1.70	198
	720	226	201	6	3	3 940	8 110	270	360		468	676	12.5	5	2.5	0.39	1.74	2.59	1.70	354
	720	283	226	6	3	4 940	10 100	270	360		468	679	28.5	5	2.5	0.40	1.68	2.51	1.65	418
460	680	163	145	6	3	2 500	5 340	280	370	46292 46292A 46392 46392A	488	637	9	5	2.5	0.37	1.83	2.72	1.78	196
	680	204	163	6	3	3 220	6 850	280	370		488	646	20.5	5	2.5	0.39	1.74	2.59	1.70	232
	760	240	214	7.5	4	4 580	9 000	250	330		496	710	13	6	3	0.39	1.74	2.59	1.70	424
	760	300	240	7.5	4	5 680	11 600	250	330		496	718	30	6	3	0.39	1.74	2.59	1.70	506
480	700	165	147	6	3	2 530	5 300	260	340	46296 46296A 46396 46396A	508	672	9	5	2.5	0.33	2.03	3.02	1.98	186
	700	206	165	6	3	3 220	7 230	260	340		508	666	20.5	5	2.5	0.33	2.03	3.02	1.98	240
	790	248	221	7.5	4	4 640	8 920	230	310		516	742	13.5	6	3	0.39	1.74	2.59	1.70	457
	790	310	248	7.5	4	5 990	12 400	230	310		516	749	31	6	3	0.39	1.74	2.59	1.70	560
500	720	167	149	6	3	2 580	5 690	250	330	462/500 462/500A 463/500 463/500A	528	679	9	5	2.5	0.40	1.71	2.54	1.67	210
	720	209	167	6	3	3 500	7 850	250	330		528	690	21	5	2.5	0.42	1.62	2.41	1.58	258
	830	264	235	7.5	4	5 220	10 900	210	280		536	776	14.5	6	3	0.39	1.74	2.59	1.70	559
	830	330	264	7.5	4	6 780	14 000	210	280		536	784	33	6	3	0.39	1.74	2.59	1.70	669

[Remark] Bearings not shown above (e.g. inch series) are shown in catalog "large size ball & roller bearings".

Double-row tapered roller bearings

TDI type

d 100 ~ (220) mm

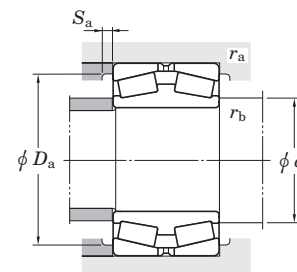
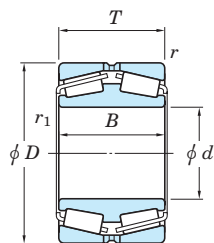

Boundary dimensions (mm)						Basic load ratings (kN)		Limiting speeds (min <sup>-1</sup> )		Bearing No.	Mounting dimensions (mm)					Constant e	Axial load factors			(Refer.) Mass (kg)	
d	D	B	T	r min.	r1 min.	Cr	C0r	Grease lub.	Oil lub.		da max.	Da max.	Da min.	Sa min.	ra max.		rb max.	Y2	Y3		Y0
100	165	52	52	2	2.5	237	384	1 800	2 300	45320	119	155	148	3.9	2	2	0.35	1.95	2.90	1.91	4.26
	180	56	56	2	2.5	300	505	1 600	2 100		45322	128	170	160	4	2	2	0.35	1.95	2.90	1.91
120	180	46	46	2	2.5	229	424	1 500	2 100	45224 45324	138	170	163	4	2	2	0.26	2.55	3.80	2.50	4.08
	200	62	62	2	2.5	353	598	1 400	1 900		45324	142	190	178	4	2	2	0.35	1.95	2.90	1.91
130	200	52	52	2	2.5	300	548	1 400	1 800	45226 45326	152	190	179	4	2	2	0.27	2.47	3.67	2.41	5.96
	210	64	64	2	2.5	412	657	1 300	1 800		45326	153	200	185	4	2	2	0.36	1.87	2.79	1.83
140	210	53	53	2	2.5	311	564	1 300	1 800	45228 45328	159	200	188	4	2	2	0.27	2.47	3.67	2.41	6.45
	225	68	68	2.5	3	486	807	1 200	1 700		45328	160	213	210	4	2	2.5	0.40	1.68	2.50	1.64
150	225	56	56	2.5	3	355	686	1 200	1 600	45230 45330	174	213	203	4	2	2.5	0.26	2.55	3.80	2.50	7.87
	250	80	80	2.5	3	593	955	1 100	1 500		45330	179	238	220	4	2	2.5	0.35	1.95	2.90	1.91
160	240	60	60	2.5	3	421	705	1 100	1 500	45232 45332	184	228	217	5	2	2.5	0.24	2.79	4.15	2.73	9.22
	270	86	86	2.5	3	678	1 100	1 000	1 400		45332	193	258	237	4	2	2.5	0.35	1.95	2.90	1.91
170	260	67	67	2.5	3	521	956	1 000	1 400	45234 45334	195	248	233	5	2	2.5	0.31	2.21	3.29	2.16	12.4
	280	88	88	2.5	3	723	1 210	970	1 300		45334	201	268	247	5	2	2.5	0.33	2.03	3.02	1.98
180	280	74	74	2.5	3	575	1 050	950	1 300	45236 45336	208	268	250	5	2	2.5	0.28	2.43	3.61	2.37	16.8
	300	96	96	3	4	860	1 370	910	1 200		45336	210	286	263	5	2.5	3	0.35	1.95	2.90	1.91
190	290	75	75	2.5	3	599	1 130	900	1 200	45238 45338	219	278	260	5	2	2.5	0.26	2.55	3.80	2.50	17.7
	320	104	104	3	4	981	1 590	840	1 100		45338	224	306	280	5	2.5	3	0.35	1.95	2.90	1.91
200	310	82	82	2.5	3	728	1 410	830	1 100	45240 45340	234	298	280	5	2	2.5	0.26	2.55	3.80	2.50	22.9
	340	112	112	3	4	1 080	1 840	770	1 000		45340	244	326	300	5	2.5	3	0.35	1.95	2.90	1.91
220	340	90	90	3	4	805	1 460	740	990	45244	259	326	306	5	2.5	3	0.28	2.43	3.61	2.37	28.5

[Remark] Bearings not shown above (e.g. inch series) are shown in catalog "large size ball & roller bearings".



# Double-row tapered roller bearings

## TDI type

$d$  (220) ~ (420) mm

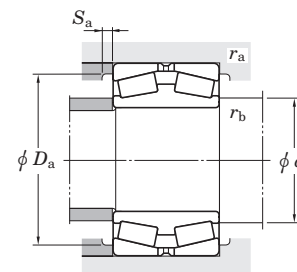
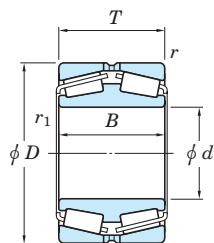

Boundary dimensions (mm)						Basic load ratings (kN)		Limiting speeds (min <sup>-1</sup> )		Bearing No.	Mounting dimensions (mm)					Constant $e$	Axial load factors			(Refer.) Mass (kg)	
$d$	$D$	$B$	$T$	$r_{min.}$	$r_{1 min.}$	$C_r$	$C_{0r}$	Grease lub.	Oil lub.		$d_a$ max.	$D_a$ max.	$S_a$ min.	$r_a$ max.	$r_b$ max.		$Y_2$	$Y_3$	$Y_0$		
220	370	120	120	4	5	1 210	2 060	700	930	45344	263	352	324	5	3	4	0.35	1.95	2.90	1.91	50.8
	230	350	90	90	3	4	791	1 560	710		950	267	336	318	6	2.5	3	0.28	2.43	3.61	2.37
240	360	92	92	3	4	915	1 790	690	920	45248 45348	271	346	325	5	2.5	3	0.32	2.12	3.15	2.07	32.2
	400	128	128	4	5	1 430	2 470	630	840		286	382	354	5	3	4	0.35	1.95	2.90	1.91	65.4
260	400	104	104	4	5	1 140	2 120	610	810	45252 45352	302	382	360	6	3	4	0.25	2.74	4.08	2.68	48.1
	440	144	144	4	5	1 890	3 440	560	750		313	422	386	6	3	4	0.35	1.95	2.90	1.91	92.2
280	420	106	106	4	5	1 190	2 470	560	750	45256 45356	321	402	370	6	3	4	0.25	2.69	4.00	2.63	51.9
	460	146	146	5	6	1 930	3 320	520	700		323	438	409	6	4	5	0.39	1.74	2.59	1.70	93.1
300	460	118	118	4	5	1 610	3 150	500	670	45260 45360	350	442	418	6	3	4	0.25	2.74	4.08	2.68	78.5
	500	160	160	5	6	2 120	4 240	470	630		356	478	440	6	4	5	0.35	1.95	2.90	1.91	129
320	480	121	121	4	5	1 630	3 180	470	630	45264 45364R	368	462	434	6	3	4	0.26	2.55	3.80	2.50	77.8
	540	176	176	5	6	2 690	5 280	430	570		378	518	474	6	4	5	0.32	2.12	3.15	2.07	167
340	520	133	133	5	6	1 880	3 850	420	570	45268 45368	398	498	464	6	4	5	0.26	2.55	3.80	2.50	104
	580	190	190	5	6	3 290	5 470	390	510		401	558	515	6	4	5	0.32	2.12	3.15	2.07	202
360	540	134	134	5	6	2 050	3 910	400	540	45272 45372	408	518	488	11	4	5	0.32	2.12	3.15	2.07	101
	600	192	192	5	6	3 360	6 750	360	490		419	578	528	10	4	5	0.32	2.12	3.15	2.07	228
380	560	135	135	5	6	2 060	3 790	380	500	45276 45376	428	538	510	6	4	5	0.27	2.47	3.67	2.41	112
	620	194	194	5	6	3 070	6 360	340	450		445	598	545	6	4	5	0.32	2.12	3.15	2.07	234
400	600	148	148	5	6	2 410	4 960	340	450	45280 45380	452	578	545	6	4	5	0.33	2.03	3.02	1.98	143
	650	200	200	6	6	3 850	7 810	320	420		458	622	580	11	5	5	0.39	1.74	2.59	1.70	265
420	620	150	150	5	6	2 600	5 200	320	430	45284	475	598	564	6	4	5	0.33	2.03	3.02	1.98	152

[Remark] Bearings not shown above (e.g. inch series) are shown in catalog "large size ball & roller bearings".

Double-row tapered roller bearings

TDI type

$d$  (420) ~ 500 mm

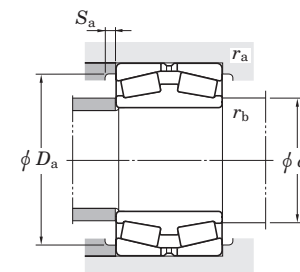
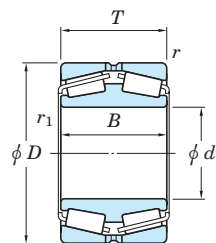

Boundary dimensions (mm)						Basic load ratings (kN)		Limiting speeds (min <sup>-1</sup> )		Bearing No.	Mounting dimensions (mm)					Constant $e$	Axial load factors			(Refer.) Mass (kg)	
$d$	$D$	$B$	$T$	$r_{min.}$	$r_{1 min.}$	$C_r$	$C_{0r}$	Grease lub.	Oil lub.		$d_a$ max.	$D_a$ max.	$S_a$ min.	$r_a$ max.	$r_b$ max.		$Y_2$	$Y_3$	$Y_0$		
420	700	224	224	6	6	4 710	8 380	280	380	45384	488	672	623	7	5	5	0.39	1.74	2.59	1.70	352
440	650	157	157	6	6	2 750	5 500	300	390	45288 45388	500	622	592	10	5	5	0.28	2.43	3.61	2.37	182
		720	226	226	6	6	4 990	9 130	270		360	506	692	642	7	5	5	0.39	1.74	2.59	1.70
460	680	163	163	6	6	3 000	5 660	280	370	45292 45392	510	652	616	6	5	5	0.39	1.74	2.59	1.70	197
		760	240	240	7.5	7.5	5 230	10 400	250		330	532	724	677	7	6	6	0.39	1.74	2.59	1.70
480	700	165	165	6	6	3 060	6 710	260	350	45296 45396	531	672	625	6	5	5	0.40	1.68	2.50	1.64	215
		790	248	248	7.5	7.5	5 710	11 600	230		310	555	754	703	7	6	6	0.39	1.74	2.59	1.70
500	720	167	167	6	6	3 430	7 350	250	330	452/500 453/500	545	692	645	8	5	5	0.39	1.74	2.59	1.70	222
		830	264	264	7.5	7.5	6 280	12 300	210		280	587	794	729	7	6	6	0.33	2.03	3.02	1.98

[Remark] Bearings not shown above (e.g. inch series) are shown in catalog "large size ball & roller bearings".

## Spherical roller bearings

Spherical roller bearings feature a large load rating capacity and self-aligning capability.

This type of bearing is suitable for low- or medium-speed applications which involve heavy or impact loading.

- These bearings are divided into R(RR), RH(RHR) and RHA types, which differ in internal structure. (refer to Table 1.)
- Each type can be produced with a cylindrical bore or tapered bore.

Bearings with a tapered bore can be fit and removed easily using an adapter assembly or withdrawal sleeve.

The rate of taper is equivalent among all bearing series.  
 240 and 241 series ... 1 : 30 (supplementary code "K30")  
 Others ... 1 : 12 (supplementary code "K")

### Spherical roller bearings



Cylindrical bore    Tapered bore  
 Bore diameter **25 – 500 mm**

### Adapter assemblies



Bore diameter **20 – 470 mm**



### Withdrawal sleeves

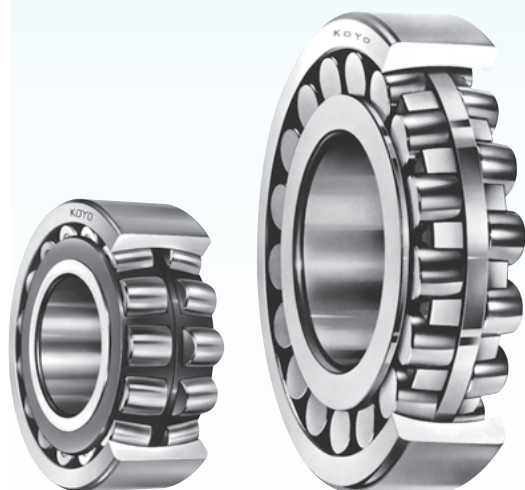

Bore diameter **35 – 480 mm**



**Table 1 Spherical roller bearings : types and structures**

Structure	 R, RR type	 RH, RHR type	 RHA type
Roller	Convex asymmetrical roller	Convex symmetrical roller	Convex symmetrical roller
Cage	Copper alloy prong type machined cage	Pressed steel cage	Copper alloy integral type machined cage
Inner ring (with or without rib)	With center rib	Without center rib (guide ring)	Without center rib (guide ring)
	With ribs on both sides (to prevent rollers from falling)	Without ribs on both sides	With ribs on both sides (to prevent rollers from falling)
Characteristics	Superior to RH, RHR and RHA types in high-speed performance.	The load rating capacity is larger than that of R and RR type. (There are some exceptional cases due to different interior specifications.)	

### ■ Spherical roller bearings for shaker screens

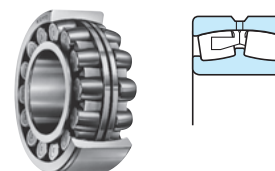

- These bearings consist of convex asymmetric rollers and a prong type, copper alloy, outer ring guided, machined cage. This cage possesses optimum characteristics for use with shaker screens.
- The bearings most commonly used with shaker screens are 223 series spherical roller bearings. They are identified by the supplementary code "ROVS W502." The outer ring outside diameter tolerance of these bearings is held to a small allowable variation.



Spherical roller bearings

d 25 ~ 70 mm

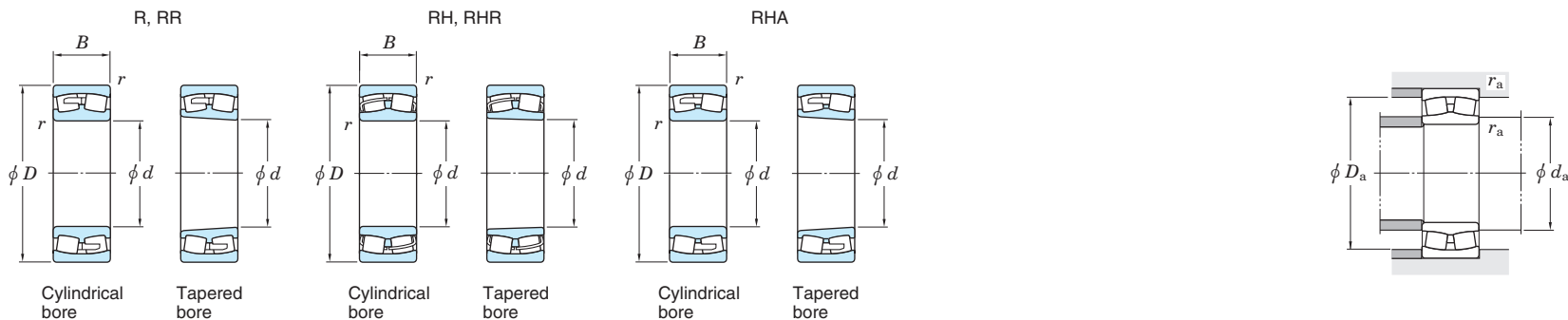

Boundary dimensions (mm)				Basic load ratings (kN)		Limiting speeds (min <sup>-1</sup> )		Bearing No.		Mounting dimensions (mm)			Constant e	Axial load factors			(Refer.) Mass (kg)	
d	D	B	r <sub>min.</sub>	C <sub>r</sub>	C <sub>0r</sub>	Grease lub.	Oil lub.	Cylindrical bore	Tapered bore	d <sub>a</sub> min.	D <sub>a</sub> max.	r <sub>a</sub> max.		Y <sub>1</sub>	Y <sub>2</sub>	Y <sub>0</sub>	Cylindrical bore	Tapered bore
25	52	18	1	45.4	48.1	7 000	9 300	22205RHR	22205RHRK	31	46	1	0.35	1.91	2.85	1.87	0.188	0.184
	62	20	1	61.2	65.9	5 900	7 900	22206RHR	22206RHRK	36	56	1	0.33	2.04	3.04	2.00	0.296	0.290
30	72	19	1.1	59.3	62.7	5 200	7 000	21306RH	21306RHK	37	65	1	0.27	2.49	3.71	2.43	0.430	0.424
	72	23	1.1	80.3	88.7	5 000	6 700	22207RHR	22207RHRK	42	65	1	0.32	2.09	3.11	2.04	0.459	0.449
35	80	21	1.5	69.6	75.3	4 500	6 000	21307RH	21307RHK	43.5	71.5	1.5	0.27	2.49	3.71	2.43	0.572	0.564
	80	23	1.1	90.9	102	4 500	6 000	22208RHR	22208RHRK	47	73	1	0.28	2.37	3.53	2.32	0.602	0.591
40	90	23	1.5	85.7	95.5	4 100	5 500	21308RH	21308RHK	48.5	81.5	1.5	0.26	2.55	3.80	2.50	0.781	0.770
	90	33	1.5	136	152	4 100	5 500	22308RHR	22308RHRK	48.5	81.5	1.5	0.37	1.83	2.72	1.79	1.08	1.06
	85	23	1.1	95.6	110	4 200	5 600	22209RHR	22209RHRK	52	78	1	0.26	2.55	3.80	2.50	0.602	0.590
45	100	25	1.5	108	124	3 600	4 900	21309RH	21309RHK	53.5	91.5	1.5	0.26	2.62	3.90	2.56	1.05	1.04
	100	36	1.5	166	183	3 700	4 900	22309RHR	22309RHRK	53.5	91.5	1.5	0.37	1.83	2.72	1.79	1.42	1.39
	90	23	1.1	103	122	3 900	5 200	22210RHR	22210RHRK	57	83	1	0.24	2.79	4.15	2.73	0.648	0.634
50	110	27	2	128	151	3 300	4 400	21310RH	21310RHK	60	100	2	0.25	2.71	4.04	2.65	1.37	1.35
	110	40	2	204	237	3 300	4 500	22310RHR	22310RHRK	60	100	2	0.36	1.85	2.76	1.81	1.92	1.88
	100	25	1.5	124	144	3 400	4 600	22211RHR	22211RHRK	63.5	91.5	1.5	0.24	2.84	4.23	2.78	0.867	0.849
55	120	29	2	144	165	3 000	4 100	21311RH	21311RHK	65	110	2	0.25	2.71	4.03	2.65	1.69	1.67
	120	43	2	236	264	3 000	4 000	22311RHR	22311RHRK	65	110	2	0.36	1.85	2.76	1.81	2.40	2.35
	110	28	1.5	153	181	3 100	4 200	22212RHR	22212RHRK	68.5	101.5	1.5	0.25	2.74	4.08	2.68	1.19	1.17
60	130	31	2.1	168	193	2 800	3 700	21312RH	21312RHK	72	118	2	0.24	2.78	4.14	2.72	2.11	2.08
	130	46	2.1	283	334	2 800	3 700	22312RHR	22312RHRK	72	118	2	0.36	1.86	2.77	1.82	3.06	2.99
	120	31	1.5	178	211	2 900	3 800	22213RHR	22213RHRK	73.5	111.5	1.5	0.25	2.69	4.00	2.63	1.55	1.52
65	140	33	2.1	194	232	2 600	3 400	21313RH	21313RHK	77	128	2	0.24	2.83	4.21	2.76	2.62	2.58
	140	48	2.1	305	360	2 600	3 400	22313RHR	22313RHRK	77	128	2	0.34	1.98	2.94	1.93	3.66	3.58
	125	31	1.5	187	222	2 700	3 600	22214RHR	22214RHRK	78.5	116.5	1.5	0.24	2.87	4.27	2.80	1.64	1.61
70	150	35	2.1	215	260	2 400	3 200	21314RH	21314RHK	82	138	2	0.24	2.84	4.23	2.78	3.19	3.15
	150	51	2.1	348	413	2 400	3 200	22314RHR	22314RHRK	82	138	2	0.34	1.98	2.94	1.93	4.45	4.36

[Remark] Standard cage types used for the above bearings are shown in Table 5 earlier in this section.

Spherical roller bearings

d 75 ~ (110) mm

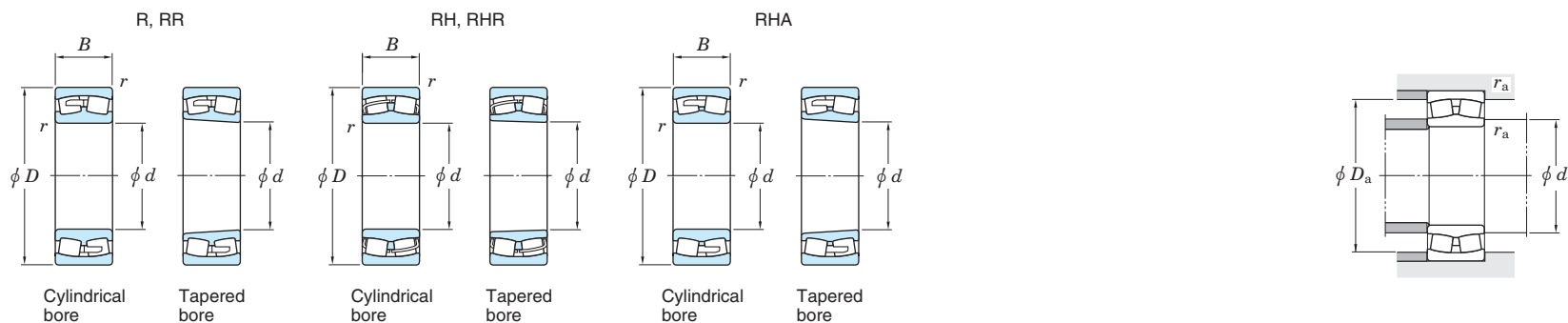

Boundary dimensions (mm)				Basic load ratings (kN)		Limiting speeds (min <sup>-1</sup> )		Bearing No.		Mounting dimensions (mm)			Constant e	Axial load factors			(Refer.) Mass (kg)	
d	D	B	r <sub>min.</sub>	C <sub>r</sub>	C <sub>0r</sub>	Grease lub.	Oil lub.	Cylindrical bore	Tapered bore	d <sub>a</sub> min.	D <sub>a</sub> max.	r <sub>a</sub> max.		Y <sub>1</sub>	Y <sub>2</sub>	Y <sub>0</sub>	Cylindrical bore	Tapered bore
75	130	31	1.5	193	236	2 600	3 400	22215RHR	22215RHRK	83.5	121.5	1.5	0.22	3.07	4.57	3.00	1.73	1.69
	160	37	2.1	246	298	2 200	3 000	21315RH	21315RHK	87	148	2	0.24	2.87	4.27	2.80	3.81	3.76
	160	55	2.1	393	473	2 200	3 000	22315RHR	22315RHRK	87	148	2	0.35	1.95	2.90	1.91	5.45	5.33
80	140	33	2	217	271	2 400	3 200	22216RHR	22216RHRK	90	130	2	0.22	3.07	4.57	3.00	2.17	2.13
	170	39	2.1	275	339	2 100	2 800	21316RH	21316RHK	92	158	2	0.23	2.88	4.29	2.82	4.53	4.47
	170	58	2.1	431	521	2 100	2 800	22316RHR	22316RHRK	92	158	2	0.35	1.95	2.90	1.91	6.44	6.30
85	150	36	2	258	324	2 200	3 000	22217RHR	22217RHRK	95	140	2	0.22	3.01	4.48	2.94	2.75	2.69
	180	41	3	300	372	2 000	2 600	21317RH	21317RHK	99	166	2.5	0.23	2.89	4.33	2.83	5.32	5.25
	180	60	3	481	586	2 000	2 600	22317RHR	22317RHRK	99	166	2.5	0.33	2.02	3.00	1.97	7.47	7.31
90	160	40	2	298	381	2 100	2 800	22218RHR	22218RHRK	100	150	2	0.24	2.79	4.15	2.73	3.50	3.43
	160	52.4	2	336	482	2 100	2 800	23218RH	23218RHK	100	150	2	0.32	2.14	3.19	2.09	4.63	4.50
	190	43	3	330	416	1 900	2 500	21318RH	21318RHK	104	176	2.5	0.23	2.91	4.30	2.84	6.20	6.11
	190	64	3	538	662	1 900	2 500	22318RHR	22318RHRK	104	176	2.5	0.34	2.00	2.98	1.96	8.82	8.63
95	170	43	2.1	334	422	2 000	2 600	22219RHR	22219RHRK	107	158	2	0.24	2.76	4.11	2.70	4.24	4.15
	200	45	3	362	461	1 800	2 300	21319RH	21319RHK	109	186	2.5	0.23	2.92	4.35	2.86	7.16	7.06
	200	67	3	586	726	1 800	2 300	22319RHR	22319RHRK	109	186	2.5	0.33	2.02	3.00	1.97	10.2	9.98
100	150	37	1.5	208	332	2 100	2 800	23020RH	23020RHK	117	141	1.5	0.22	3.01	4.48	2.94	2.34	2.27
	180	46	2.1	377	481	1 900	2 500	22220RHR	22220RHRK	112	168	2	0.25	2.74	4.08	2.68	5.11	5.00
	180	60.3	2.1	425	629	1 900	2 500	23220RH	23220RHK	112	168	2	0.32	2.09	3.11	2.04	6.85	6.66
	215	47	3	416	524	1 600	2 200	21320RH	21320RHK	114	201	2.5	0.22	3.02	4.49	2.95	8.79	8.68
	215	73	3	700	877	1 600	2 200	22320RHR	22320RHRK	114	201	2.5	0.35	1.95	2.90	1.91	13.2	12.9
110	170	45	2	300	486	1 900	2 500	23022RH	23022RHK	120	160	2	0.24	2.84	4.23	2.78	3.85	3.74
	180	56	2	385	605	1 800	2 400	23122RH	23122RHK	120	170	2	0.29	2.36	3.51	2.31	5.72	5.54
	180	69	2	469	778	1 800	2 400	24122RH	24122RHK30	120	170	2	0.37	1.84	2.74	1.80	6.98	6.87
	200	53	2.1	491	642	1 700	2 200	22222RHR	22222RHRK	122	188	2	0.26	2.64	3.93	2.58	7.37	7.21
	200	69.8	2.1	537	792	1 700	2 200	23222RH	23222RHK	122	188	2	0.34	1.99	2.96	1.94	9.76	9.48
	240	50	3	484	616	1 400	1 900	21322RH	21322RHK	124	226	2.5	0.21	3.19	4.75	3.12	11.8	11.7

[Remark] Standard cage types used for the above bearings are shown in Table 5 earlier in this section.

Spherical roller bearings

d (110) ~ (150) mm

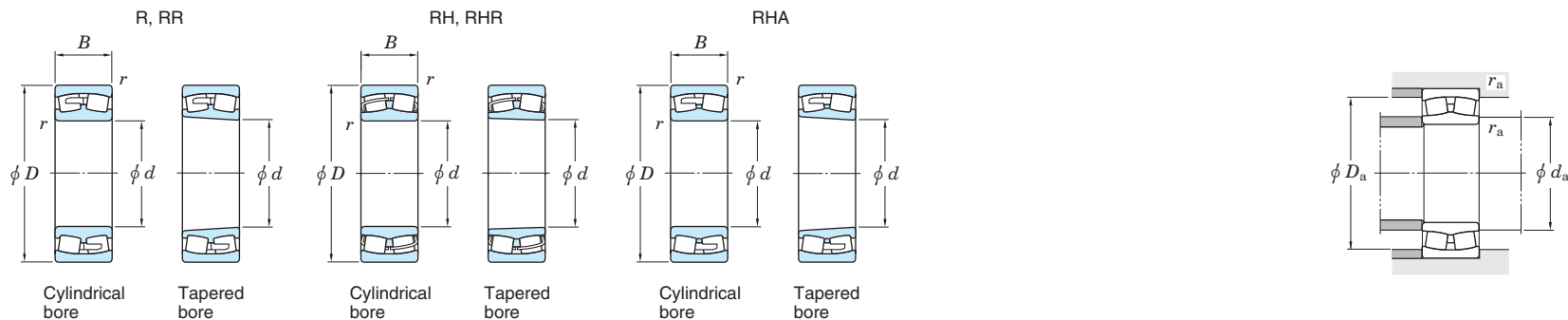

Boundary dimensions (mm)				Basic load ratings (kN)		Limiting speeds (min <sup>-1</sup> )		Bearing No.		Mounting dimensions (mm)			Constant e	Axial load factors			(Refer.) Mass (kg)	
d	D	B	r <sub>min.</sub>	C <sub>r</sub>	C <sub>0r</sub>	Grease lub.	Oil lub.	Cylindrical bore	Tapered bore	d <sub>a</sub> min.	D <sub>a</sub> max.	r <sub>a</sub> max.		Y <sub>1</sub>	Y <sub>2</sub>	Y <sub>0</sub>	Cylindrical bore	Tapered bore
110	240	80	3	828	1 040	1 400	1 900	22322RHR	22322RHRK	124	226	2.5	0.33	2.03	3.02	1.98	18.1	17.7
120	180	46	2	314	524	1 700	2 300	23024RH	23024RHK	130	170	2	0.23	2.95	4.40	2.89	4.20	4.07
	180	60	2	397	709	1 700	2 300	24024RH	24024RHK30	130	170	2	0.30	2.23	3.32	2.18	5.43	5.34
	200	62	2	454	714	1 600	2 200	23124RH	23124RHK	130	190	2	0.29	2.34	3.49	2.29	7.98	7.74
	200	80	2	605	1 020	1 600	2 200	24124RH	24124RHK30	130	190	2	0.38	1.75	2.61	1.72	10.2	10.0
	215	58	2.1	565	764	1 500	2 000	22224RHR	22224RHRK	132	203	2	0.26	2.60	3.87	2.54	9.31	9.10
	215	76	2.1	616	956	1 500	2 100	23224RH	23224RHK	132	203	2	0.34	1.97	2.94	1.93	12.2	11.8
	260	86	3	896	1 130	1 300	1 800	22324RHR	22324RHRK	134	246	2.5	0.33	2.03	3.02	1.98	22.8	22.3
130	200	52	2	404	674	1 600	2 100	23026RH	23026RHK	140	190	2	0.24	2.87	4.27	2.80	6.15	5.97
	200	69	2	512	914	1 600	2 100	24026RH	24026RHK30	140	190	2	0.32	2.14	3.18	2.09	8.03	7.90
	210	64	2	494	799	1 500	2 000	23126RH	23126RHK	140	200	2	0.28	2.42	3.61	2.37	8.71	8.44
	210	80	2	620	1 080	1 500	2 000	24126RH	24126RHK30	140	200	2	0.36	1.90	2.83	1.86	10.8	10.6
	230	64	3	658	914	1 400	1 900	22226RHR	22226RHRK	144	216	2.5	0.26	2.55	3.80	2.50	11.6	11.3
	230	80	3	702	1 090	1 400	1 900	23226RH	23226RHK	144	216	2.5	0.33	2.05	3.05	2.00	14.4	14.0
	280	93	4	1 040	1 340	1 200	1 600	22326RHR	22326RHRK	148	262	3	0.33	2.03	3.02	1.98	28.5	27.9
140	210	53	2	422	723	1 500	2 000	23028RH	23028RHK	150	200	2	0.23	2.98	4.44	2.92	6.62	6.42
	210	69	2	524	957	1 500	2 000	24028RH	24028RHK30	150	200	2	0.30	2.28	3.39	2.23	8.49	8.35
	225	68	2.1	565	940	1 400	1 900	23128RH	23128RHK	152	213	2	0.28	2.45	3.65	2.40	10.6	10.3
	225	85	2.1	702	1 220	1 400	1 900	24128RH	24128RHK30	152	213	2	0.36	1.89	2.82	1.85	13.1	12.9
	250	68	3	759	1 030	1 300	1 700	22228RHR	22228RHRK	154	236	2.5	0.26	2.60	3.87	2.54	14.5	14.2
	250	88	3	811	1 290	1 300	1 700	23228RH	23228RHK	154	236	2.5	0.34	1.99	2.96	1.95	19.0	18.4
	300	102	4	1 170	1 570	1 100	1 500	22328RH	22328RHK	158	282	3	0.35	1.95	2.90	1.90	35.7	34.9
150	210	45	2	334	622	1 600	2 100	23930R	23930RK	160	200	2	0.20	3.44	5.12	3.36	5.09	4.93
	225	56	2.1	461	797	1 400	1 800	23030RH	23030RHK	162	213	2	0.22	3.04	4.53	2.97	8.01	7.77
	225	75	2.1	593	1 100	1 400	1 800	24030RH	24030RHK30	162	213	2	0.30	2.23	3.32	2.18	10.6	10.4
	250	80	2.1	717	1 230	1 300	1 700	23130RH	23130RHK	162	238	2	0.30	2.24	3.34	2.19	16.4	15.9
	250	100	2.1	915	1 590	1 300	1 700	24130RH	24130RHK30	162	238	2	0.38	1.77	2.64	1.73	19.9	19.6

[Remark] Standard cage types used for the above bearings are shown in Table 5 earlier in this section.

Spherical roller bearings

d (150) ~ (180) mm

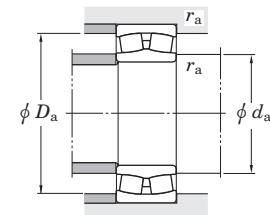
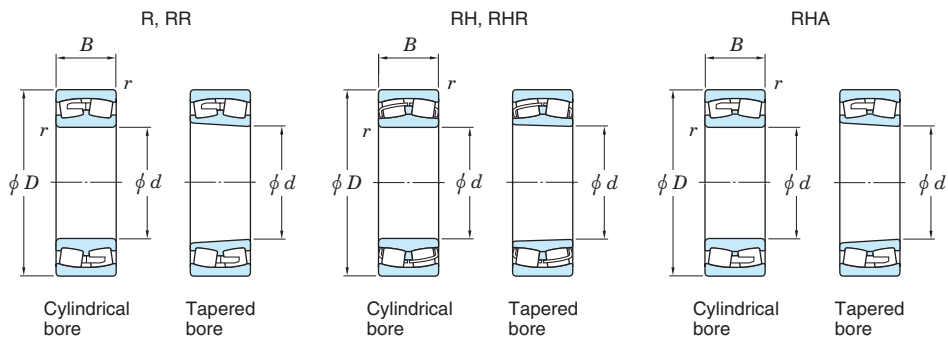

Boundary dimensions (mm)				Basic load ratings (kN)		Limiting speeds (min <sup>-1</sup> )		Bearing No.		Mounting dimensions (mm)			Constant e	Axial load factors			(Refer.) Mass (kg)	
d	D	B	r <sub>min.</sub>	C <sub>r</sub>	C <sub>0r</sub>	Grease lub.	Oil lub.	Cylindrical bore	Tapered bore	d <sub>a</sub> min.	D <sub>a</sub> max.	r <sub>a</sub> max.		Y <sub>1</sub>	Y <sub>2</sub>	Y <sub>0</sub>	Cylindrical bore	Tapered bore
<b>150</b>	270	73	3	865	1 200	1 200	1 600	<b>22230RHR</b>	<b>22230RHRK</b>	164	256	2.5	0.25	2.69	4.00	2.63	18.9	18.5
	270	96	3	959	1 540	1 200	1 600	<b>23230RH</b>	<b>23230RHK</b>	164	256	2.5	0.34	1.96	2.93	1.92	24.5	23.8
	320	108	4	1 230	1 600	1 200	1 500	<b>22330R</b>	<b>22330RK</b>	168	302	3	0.38	1.78	2.64	1.74	43.6	42.7
	320	108	4	1 290	1 740	1 200	1 500	<b>22330RHA</b>	<b>22330RHAK</b>	168	302	3	0.35	1.93	2.87	1.88	40.3	39.4
<b>160</b>	220	45	2	341	649	1 500	2 000	<b>23932R</b>	<b>23932RK</b>	170	210	2	0.19	3.60	5.37	3.52	5.37	5.20
	240	60	2.1	531	924	1 300	1 700	<b>23032RH</b>	<b>23032RHK</b>	172	228	2	0.22	3.01	4.48	2.94	9.74	9.44
	240	80	2.1	679	1 270	1 300	1 700	<b>24032RH</b>	<b>24032RHK30</b>	172	228	2	0.30	2.24	3.34	2.19	12.9	12.7
	270	86	2.1	848	1 430	1 200	1 600	<b>23132RH</b>	<b>23132RHK</b>	172	258	2	0.30	2.22	3.30	2.17	20.8	20.2
	290	80	3	885	1 270	1 200	1 600	<b>22232R</b>	<b>22232RK</b>	174	276	2.5	0.28	2.40	3.57	2.35	23.4	22.9
	290	80	3	897	1 320	1 200	1 600	<b>22232RHA</b>	<b>22232RHAK</b>	174	276	2.5	0.27	2.49	3.71	2.44	21.9	21.4
	290	104	3	1 030	1 650	1 200	1 600	<b>23232R</b>	<b>23232RK</b>	174	276	2.5	0.38	1.79	2.66	1.75	31.0	30.1
	290	104	3	1 100	1 780	1 200	1 600	<b>23232RHA</b>	<b>23232RHAK</b>	174	276	2.5	0.36	1.87	2.78	1.83	29.4	28.5
	340	114	4	1 380	1 790	1 100	1 400	<b>22332R</b>	<b>22332RK</b>	178	322	3	0.38	1.76	2.62	1.72	51.9	51.0
	340	114	4	1 420	1 940	1 100	1 400	<b>22332RHA</b>	<b>22332RHAK</b>	178	322	3	0.35	1.94	2.89	1.90	48.0	47.1
<b>170</b>	230	45	2	353	691	1 400	1 900	<b>23934R</b>	<b>23934RK</b>	180	220	2	0.18	3.78	5.63	3.70	5.67	5.49
	260	67	2.1	632	1 090	1 200	1 600	<b>23034RH</b>	<b>23034RHK</b>	182	248	2	0.23	2.90	4.31	2.83	13.2	12.8
	260	90	2.1	828	1 540	1 200	1 600	<b>24034RH</b>	<b>24034RHK30</b>	182	248	2	0.32	2.11	3.15	2.07	17.5	17.2
	280	88	2.1	916	1 550	1 100	1 500	<b>23134RH</b>	<b>23134RHK</b>	182	268	2	0.29	2.30	3.43	2.25	21.9	21.2
	280	109	2.1	1 050	1 820	1 600	1 200	<b>24134RR</b>	<b>24134RRK30</b>	182	268	2	0.37	1.80	2.68	1.76	27.2	26.8
	310	86	4	952	1 390	1 100	1 500	<b>22234R</b>	<b>22234RK</b>	188	292	3	0.29	2.29	3.41	2.24	29.0	28.4
	310	86	4	1 010	1 490	1 100	1 500	<b>22234RHA</b>	<b>22234RHAK</b>	188	292	3	0.28	2.45	3.64	2.39	27.1	26.5
	310	110	4	1 150	1 870	1 100	1 500	<b>23234R</b>	<b>23234RK</b>	188	292	3	0.37	1.81	2.70	1.77	37.5	36.5
	310	110	4	1 210	1 940	1 100	1 500	<b>23234RHA</b>	<b>23234RHAK</b>	188	292	3	0.36	1.89	2.82	1.85	35.6	34.6
	360	120	4	1 460	1 920	1 000	1 300	<b>22334R</b>	<b>22334RK</b>	188	342	3	0.38	1.77	2.64	1.73	62.0	60.8
360	120	4	1 590	2 200	1 000	1 300	<b>22334RHA</b>	<b>22334RHAK</b>	188	342	3	0.35	1.95	2.91	1.91	57.3	56.1	
<b>180</b>	250	52	2	479	939	1 300	1 700	<b>23936R</b>	<b>23936RK</b>	190	240	2	0.19	3.55	5.29	3.48	8.22	7.97
	280	74	2.1	768	1 330	1 100	1 400	<b>23036RH</b>	<b>23036RHK</b>	192	268	2	0.24	2.84	4.23	2.78	17.4	16.9

[Remark] Standard cage types used for the above bearings are shown in Table 5 earlier in this section.



Spherical roller bearings

d (180) ~ (200) mm

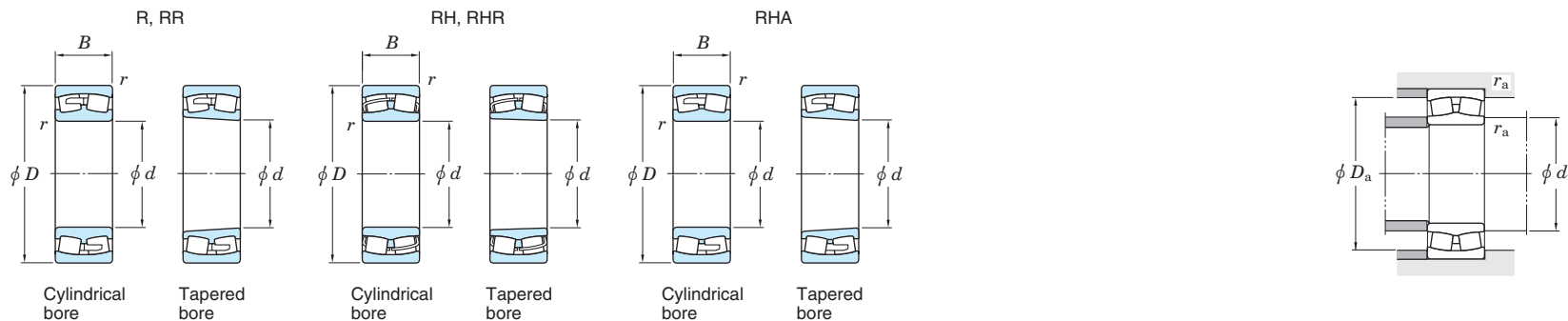

Boundary dimensions (mm)				Basic load ratings (kN)		Limiting speeds (min <sup>-1</sup> )		Bearing No.		Mounting dimensions (mm)			Constant e	Axial load factors			(Refer.) Mass (kg)		
d	D	B	r <sub>min.</sub>	C <sub>r</sub>	C <sub>0r</sub>	Grease lub.	Oil lub.	Cylindrical bore	Tapered bore	d <sub>a</sub> min.	D <sub>a</sub> max.	r <sub>a</sub> max.		Y <sub>1</sub>	Y <sub>2</sub>	Y <sub>0</sub>	Cylindrical bore	Tapered bore	
180	280	100	2.1	933	1 710	1 600	1 200	24036RR	24036RRK30	192	268	2	0.34	2.00	2.98	1.96	23.4	23.0	
	300	96	3	1 000	1 800	1 100	1 500	23136R	23136RK	194	286	2.5	0.33	2.04	3.04	2.00	28.4	27.5	
	300	96	3	1 060	1 790	1 100	1 500	23136RHA	23136RHAK	194	286	2.5	0.31	2.19	3.25	2.14	26.5	25.6	
	300	118	3	1 220	2 120	1 100	1 500	24136RR	24136RRK30	194	286	2.5	0.38	1.78	2.65	1.74	34.4	33.9	
	300	118	3	1 250	2 240	1 100	1 500	24136RHA	24136RHAK30	194	286	2.5	0.38	1.79	2.66	1.75	31.8	31.2	
	320	86	4	978	1 450	1 100	1 400	22236R	22236RK	198	302	3	0.28	2.37	3.53	2.32	30.5	29.8	
	320	86	4	1 060	1 610	1 100	1 400	22236RHA	22236RHAK	198	302	3	0.26	2.55	3.80	2.50	28.5	27.8	
	320	112	4	1 190	1 980	1 100	1 400	23236R	23236RK	198	302	3	0.37	1.84	2.74	1.80	39.8	38.6	
	320	112	4	1 320	2 170	1 100	1 400	23236RHA	23236RHAK	198	302	3	0.34	1.97	2.93	1.92	37.7	36.5	
	380	126	4	1 740	2 360	920	1 200	22336R	22336RK	198	362	3	0.36	1.89	2.81	1.84	71.4	69.9	
	380	126	4	1 740	2 410	930	1 200	22336RHA	22336RHAK	198	362	3	0.34	1.97	2.94	1.93	66.0	64.5	
	190	260	52	2	486	969	1 200	1 600	23938R	23938RK	200	250	2	0.18	3.69	5.50	3.61	8.40	8.10
290		75	2.1	736	1 370	1 100	1 500	23038R	23038RK	202	278	2	0.25	2.67	3.97	2.61	18.8	18.2	
290		75	2.1	789	1 430	1 100	1 500	23038RHA	23038RHAK	202	278	2	0.25	2.75	4.10	2.69	17.2	16.6	
290		100	2.1	989	1 840	1 100	1 500	24038RR	24038RRK30	202	278	2	0.33	2.06	3.07	2.02	24.5	24.1	
290		100	2.1	1 010	1 920	1 100	1 500	24038RHA	24038RHAK30	202	278	2	0.32	2.14	3.19	2.09	22.4	22.0	
320		104	3	1 090	2 000	1 000	1 400	23138R	23138RK	204	306	2.5	0.34	1.96	2.92	1.92	35.5	34.4	
320		104	3	1 210	2 080	1 000	1 400	23138RHA	23138RHAK	204	306	2.5	0.31	2.14	3.19	2.10	33.2	32.1	
320		128	3	1 400	2 470	1 000	1 400	24138RR	24138RRK30	204	306	2.5	0.39	1.74	2.59	1.70	43.0	42.4	
320		128	3	1 460	2 630	1 000	1 400	24138RHA	24138RHAK30	204	306	2.5	0.38	1.76	2.63	1.72	40.1	39.5	
340		92	4	1 110	1 730	1 000	1 300	22238R	22238RK	208	322	3	0.29	2.29	3.41	2.24	37.4	36.6	
340		92	4	1 150	1 770	1 000	1 300	22238RHA	22238RHAK	208	322	3	0.27	2.52	3.76	2.46	34.9	34.1	
340		120	4	1 410	2 210	1 000	1 300	23238R	23238RK	208	322	3	0.36	1.87	2.79	1.83	47.4	46.0	
340		120	4	1 490	2 470	990	1 300	23238RHA	23238RHAK	208	322	3	0.35	1.94	2.89	1.90	44.9	43.5	
400		132	5	1 900	2 610	880	1 200	22338R	22338RK	212	378	4	0.38	1.79	2.66	1.75	84.1	82.4	
400		132	5	1 940	2 810	870	1 200	22338RHA	22338RHAK	212	378	4	0.34	1.99	2.97	1.95	77.7	76.0	
200		280	60	2.1	601	1 190	1 100	1 500	23940R	23940RK	212	268	2	0.20	3.44	5.13	3.37	12.0	11.6
		310	82	2.1	890	1 670	1 000	1 400	23040R	23040RK	212	298	2	0.26	2.62	3.90	2.56	24.1	23.4
		310	82	2.1	940	1 680	1 100	1 400	23040RHA	23040RHAK	212	298	2	0.25	2.68	3.99	2.62	22.0	21.3

[Remark] Standard cage types used for the above bearings are shown in Table 5 earlier in this section.

Spherical roller bearings

d (200) ~ (240) mm

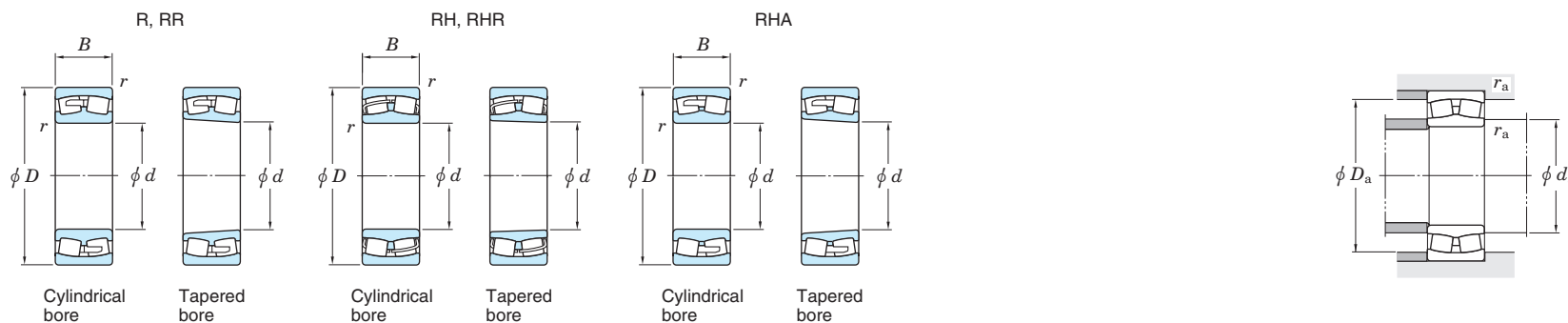

Boundary dimensions (mm)				Basic load ratings (kN)		Limiting speeds (min <sup>-1</sup> )		Bearing No.		Mounting dimensions (mm)			Constant e	Axial load factors			(Refer.) Mass (kg)	
d	D	B	r <sub>min.</sub>	C <sub>r</sub>	C <sub>0r</sub>	Grease lub.	Oil lub.	Cylindrical bore	Tapered bore	d <sub>a</sub> min.	D <sub>a</sub> max.	r <sub>a</sub> max.		Y <sub>1</sub>	Y <sub>2</sub>	Y <sub>0</sub>	Cylindrical bore	Tapered bore
200	310	109	2.1	1 140	2 110	1 100	1 400	24040RR	24040RRK30	212	298	2	0.33	2.02	3.00	1.97	31.2	30.7
	310	109	2.1	1 180	2 230	1 100	1 400	24040RHA	24040RHAK30	212	298	2	0.33	2.06	3.07	2.02	28.5	28.0
	340	112	3	1 240	2 250	980	1 300	23140R	23140RK	214	326	2.5	0.34	1.97	2.94	1.93	43.7	42.4
	340	112	3	1 380	2 340	970	1 300	23140RHA	23140RHAK	214	326	2.5	0.32	2.10	3.13	2.06	40.8	39.5
	340	140	3	1 620	2 820	990	1 300	24140RR	24140RRK30	214	326	2.5	0.40	1.68	2.49	1.64	53.3	52.5
	340	140	3	1 660	2 970	990	1 300	24140RHA	24140RHAK30	214	326	2.5	0.41	1.65	2.46	1.62	49.5	48.7
	360	98	4	1 230	1 930	930	1 200	22240R	22240RK	218	342	3	0.30	2.26	3.36	2.21	45.0	44.0
	360	98	4	1 310	2 030	940	1 300	22240RHA	22240RHAK	218	342	3	0.27	2.50	3.72	2.45	42.0	41.0
	360	128	4	1 550	2 610	940	1 300	23240R	23240RK	218	342	3	0.38	1.79	2.67	1.75	58.1	56.4
	360	128	4	1 660	2 780	930	1 200	23240RHA	23240RHAK	218	342	3	0.35	1.92	2.86	1.88	55.1	53.4
	420	138	5	2 010	2 750	830	1 100	22340R	22340RK	222	398	4	0.38	1.80	2.68	1.76	95.4	93.5
	420	138	5	2 060	2 920	820	1 100	22340RHA	22340RHAK	222	398	4	0.34	1.99	2.97	1.95	88.1	86.2
220	300	60	2.1	634	1 300	1 000	1 400	23944R	23944RK	232	288	2	0.18	3.70	5.50	3.61	13.0	12.6
	340	90	3	984	1 890	940	1 300	23044R	23044RK	234	326	2.5	0.26	2.55	3.80	2.50	31.5	30.6
	340	90	3	1 090	1 950	940	1 200	23044RHA	23044RHAK	234	326	2.5	0.25	2.69	4.01	2.63	28.8	27.9
	340	118	3	1 320	2 480	950	1 300	24044RR	24044RRK30	234	326	2.5	0.33	2.04	3.04	2.00	40.5	39.8
	340	118	3	1 380	2 630	950	1 300	24044RHA	24044RHAK30	234	326	2.5	0.33	2.08	3.09	2.03	37.0	36.4
	370	120	4	1 440	2 700	880	1 200	23144R	23144RK	238	352	3	0.34	2.00	2.98	1.96	54.8	53.2
	370	120	4	1 590	2 790	870	1 200	23144RHA	23144RHAK	238	352	3	0.31	2.15	3.20	2.10	51.2	49.6
	370	150	4	1 880	3 390	880	1 200	24144RR	24144RRK30	238	352	3	0.39	1.71	2.55	1.67	67.3	66.2
	370	150	4	1 920	3 550	880	1 200	24144RHA	24144RHAK30	238	352	3	0.40	1.69	2.52	1.65	62.0	61.0
	400	108	4	1 560	2 400	820	1 100	22244R	22244RK	238	382	3	0.28	2.40	3.57	2.34	63.0	61.7
	400	108	4	1 590	2 440	820	1 100	22244RHA	22244RHAK	238	382	3	0.27	2.52	3.76	2.47	58.8	57.5
	400	144	4	1 880	3 200	830	1 100	23244R	23244RK	238	382	3	0.39	1.71	2.55	1.68	81.6	79.2
	400	144	4	2 020	3 350	810	1 100	23244RHA	23244RHAK	238	382	3	0.36	1.89	2.81	1.85	77.4	75.0
	460	145	5	2 380	3 380	720	960	22344R	22344RK	242	438	4	0.34	2.00	2.99	1.96	124	122
	460	145	5	2 370	3 470	730	970	22344RHA	22344RHAK	242	438	4	0.32	2.08	3.09	2.03	115	113
240	320	60	2.1	651	1 380	940	1 300	23948R	23948RK	252	308	2	0.17	3.95	5.88	3.86	14.0	13.5

[Remark] Standard cage types used for the above bearings are shown in Table 5 earlier in this section.

Spherical roller bearings

d (240) ~ 260 mm

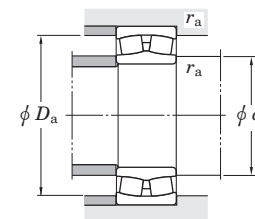
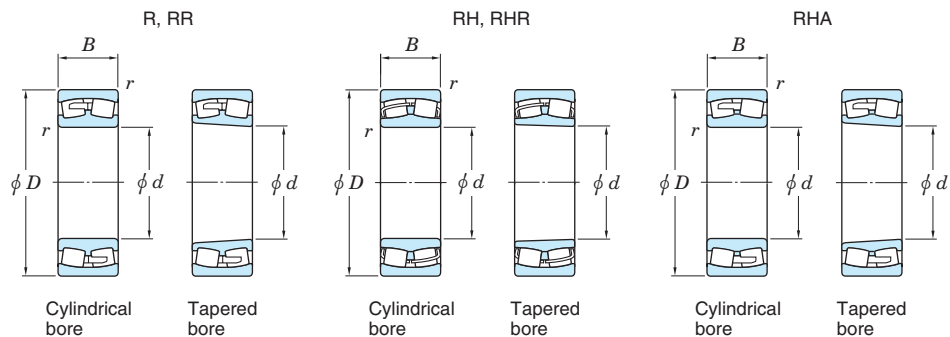

Boundary dimensions (mm)				Basic load ratings (kN)		Limiting speeds (min <sup>-1</sup> )		Bearing No.		Mounting dimensions (mm)			Constant e	Axial load factors			(Refer.) Mass (kg)	
d	D	B	r <sub>min.</sub>	C <sub>r</sub>	C <sub>0r</sub>	Grease lub.	Oil lub.	Cylindrical bore	Tapered bore	d <sub>a</sub> min.	D <sub>a</sub> max.	r <sub>a</sub> max.		Y <sub>1</sub>	Y <sub>2</sub>	Y <sub>0</sub>	Cylindrical bore	Tapered bore
240	360	92	3	1 100	2 170	860	1 100	23048R	23048RK	254	346	2.5	0.25	2.71	4.04	2.65	34.9	33.8
	360	92	3	1 170	2 180	860	1 100	23048RHA	23048RHAK	254	346	2.5	0.24	2.83	4.21	2.77	31.9	30.9
	360	118	3	1 390	2 710	870	1 200	24048RR	24048RRK30	254	346	2.5	0.31	2.20	3.27	2.15	43.5	42.9
	360	118	3	1 430	2 840	870	1 200	24048RHA	24048RHAK30	254	346	2.5	0.30	2.24	3.33	2.19	39.6	39.0
	400	128	4	1 630	3 080	790	1 100	23148R	23148RK	258	382	3	0.33	2.05	3.05	2.00	67.6	65.6
	400	128	4	1 810	3 200	790	1 000	23148RHA	23148RHAK	258	382	3	0.31	2.19	3.25	2.14	63.1	61.1
	400	160	4	2 100	3 850	800	1 100	24148RR	24148RRK30	258	382	3	0.39	1.75	2.60	1.71	82.7	81.4
	400	160	4	2 200	4 130	800	1 100	24148RHA	24148RHAK30	258	382	3	0.39	1.72	2.56	1.68	76.6	75.3
	440	120	4	1 920	2 940	730	970	22248R	22248RK	258	422	3	0.29	2.35	3.50	2.30	85.0	83.2
	440	120	4	1 920	2 990	730	970	22248RHA	22248RHAK	258	422	3	0.27	2.49	3.71	2.43	79.4	77.6
	440	160	4	2 340	3 990	730	970	23248R	23248RK	258	422	3	0.39	1.73	2.57	1.69	110	107
	440	160	4	2 460	4 130	730	970	23248RHA	23248RHAK	258	422	3	0.36	1.87	2.78	1.83	104	101
	500	155	5	2 610	4 020	650	870	22348R	22348RK	262	478	4	0.35	1.94	2.89	1.90	157	154
	500	155	5	2 720	3 990	650	870	22348RHA	22348RHAK	262	478	4	0.32	2.12	3.16	2.07	145	142
260	360	75	2.1	914	1 880	820	1 100	23952R	23952RK	272	348	2	0.19	3.54	5.27	3.46	24.0	23.3
	400	104	4	1 330	2 570	760	1 000	23052R	23052RK	278	382	3	0.25	2.65	3.95	2.59	50.7	49.3
	400	104	4	1 470	2 720	760	1 000	23052RHA	23052RHAK	278	382	3	0.25	2.75	4.10	2.69	46.3	44.9
	400	140	4	1 810	3 570	770	1 000	24052RR	24052RRK30	278	382	3	0.33	2.02	3.01	1.98	66.3	65.2
	400	140	4	1 860	3 670	770	1 000	24052RHA	24052RHAK30	278	382	3	0.33	2.06	3.07	2.02	60.3	59.4
	440	144	4	2 100	3 860	710	940	23152R	23152RK	278	422	3	0.33	2.03	3.02	1.98	93.6	90.8
	440	144	4	2 220	4 000	700	930	23152RHA	23152RHAK	278	422	3	0.32	2.12	3.16	2.08	87.4	84.6
	440	180	4	2 590	4 700	720	950	24152RR	24152RRK30	278	422	3	0.40	1.69	2.51	1.65	114	112
	440	180	4	2 650	4 950	720	950	24152RHA	24152RHAK30	278	422	3	0.41	1.66	2.47	1.62	106	105
	480	130	5	2 240	3 460	650	870	22252R	22252RK	282	458	4	0.28	2.40	3.57	2.35	110	108
	480	130	5	2 230	3 430	650	870	22252RHA	22252RHAK	282	458	4	0.27	2.50	3.72	2.44	103	101
	480	174	5	2 750	4 640	640	860	23252R	23252RK	282	458	4	0.40	1.69	2.51	1.65	144	140
	480	174	5	2 870	4 900	650	860	23252RHA	23252RHAK	282	458	4	0.36	1.87	2.78	1.83	137	133
	540	165	6	2 830	4 380	590	780	22352R	22352RK	288	512	5	0.35	1.94	2.89	1.90	196	192
	540	165	6	3 120	4 620	580	780	22352RHA	22352RHAK	288	512	5	0.31	2.15	3.21	2.11	181	177

[Remark] Standard cage types used for the above bearings are shown in Table 5 earlier in this section.

Spherical roller bearings

d 280 ~ 300 mm

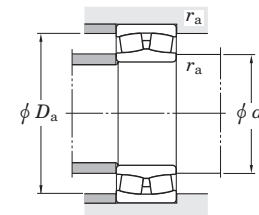
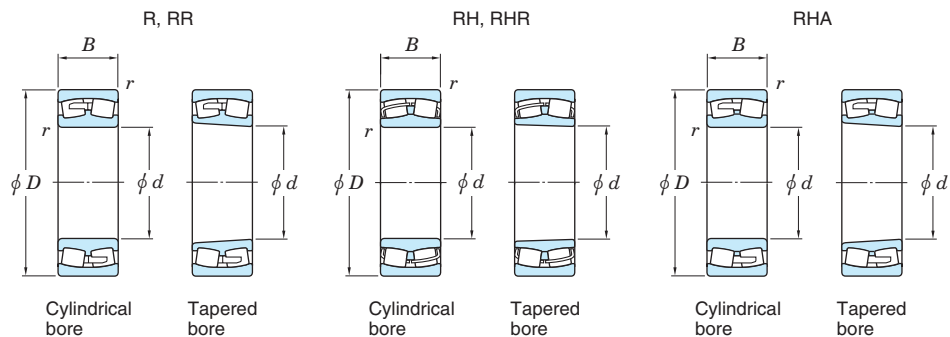

Boundary dimensions (mm)				Basic load ratings (kN)		Limiting speeds (min <sup>-1</sup> )		Bearing No.		Mounting dimensions (mm)			Constant e	Axial load factors			(Refer.) Mass (kg)	
d	D	B	r <sub>min.</sub>	C <sub>r</sub>	C <sub>0r</sub>	Grease lub.	Oil lub.	Cylindrical bore	Tapered bore	d <sub>a</sub> min.	D <sub>a</sub> max.	r <sub>a</sub> max.		Y <sub>1</sub>	Y <sub>2</sub>	Y <sub>0</sub>	Cylindrical bore	Tapered bore
280	380	75	2.1	928	1 960	760	1 000	23956R	23956RK	292	368	2	0.18	3.74	5.57	3.66	26.0	25.2
	420	106	4	1 430	2 860	710	950	23056R	23056RK	298	402	3	0.25	2.74	4.08	2.68	54.5	52.9
	420	106	4	1 550	2 950	700	940	23056RHA	23056RHAK	298	402	3	0.24	2.87	4.27	2.80	49.8	48.2
	420	140	4	1 890	3 780	710	950	24056RR	24056RRK30	298	402	3	0.31	2.15	3.21	2.11	70.2	69.1
	420	140	4	1 960	4 000	710	950	24056RHA	24056RHAK30	298	402	3	0.31	2.20	3.28	2.15	64.0	62.9
	460	146	5	2 140	4 280	660	880	23156R	23156RK	302	438	4	0.33	2.04	3.03	1.99	100	96.9
	460	146	5	2 340	4 290	650	870	23156RHA	23156RHAK	302	438	4	0.30	2.22	3.30	2.17	93.4	90.3
	460	180	5	2 700	5 140	660	880	24156RR	24156RRK30	302	438	4	0.38	1.79	2.67	1.75	122	120
	460	180	5	2 740	5 240	660	880	24156RHA	24156RHAK30	302	438	4	0.38	1.76	2.62	1.72	113	112
	500	130	5	2 100	3 380	610	810	22256R	22256RK	302	478	4	0.28	2.42	3.60	2.37	114	112
	500	130	5	2 320	3 670	610	810	22256RHA	22256RHAK	302	478	4	0.26	2.64	3.93	2.58	106	104
	500	176	5	2 690	4 910	610	820	23256R	23256RK	302	478	4	0.37	1.83	2.72	1.79	153	149
	500	176	5	3 010	5 300	600	800	23256RHA	23256RHAK	302	478	4	0.35	1.95	2.91	1.91	145	141
	580	175	6	3 150	4 910	530	710	22356R	22356RK	308	552	5	0.34	1.98	2.95	1.93	229	225
	580	175	6	3 510	5 260	530	700	22356RHA	22356RHAK	308	552	5	0.31	2.19	3.25	2.14	212	208
300	420	90	3	1 280	2 610	680	910	23960R	23960RK	314	406	2.5	0.20	3.42	5.09	3.34	40.0	38.8
	460	118	4	1 750	3 480	630	840	23060R	23060RK	318	442	3	0.25	2.69	4.00	2.63	75.8	73.7
	460	118	4	1 940	3 700	630	840	23060RHA	23060RHAK	318	442	3	0.24	2.79	4.16	2.73	68.9	66.8
	460	160	4	2 350	4 690	640	850	24060RR	24060RRK30	318	442	3	0.33	2.04	3.04	2.00	99.5	97.9
	460	160	4	2 420	4 910	640	850	24060RHA	24060RHAK30	318	442	3	0.32	2.09	3.11	2.04	90.7	89.1
	500	160	5	2 490	4 850	590	790	23160R	23160RK	322	478	4	0.33	2.02	3.01	1.98	132	128
	500	160	5	2 730	4 970	580	780	23160RHA	23160RHAK	322	478	4	0.31	2.18	3.25	2.13	123	119
	500	200	5	3 320	6 280	590	790	24160RR	24160RRK30	322	478	4	0.40	1.67	2.49	1.63	162	160
	500	200	5	3 320	6 420	590	790	24160RHA	24160RHAK30	322	478	4	0.39	1.72	2.56	1.68	150	148
	540	140	5	2 690	4 330	550	740	22260R	22260RK	322	518	4	0.27	2.48	3.69	2.43	145	142
	540	140	5	2 650	4 360	550	740	22260RHA	22260RHAK	322	518	4	0.26	2.62	3.90	2.56	135	132
	540	192	5	3 430	5 910	540	720	23260R	23260RK	322	518	4	0.37	1.83	2.72	1.79	197	192
	540	192	5	3 540	6 310	540	720	23260RHA	23260RHAK	322	518	4	0.35	1.93	2.88	1.89	187	182
	620	185	7.5	3 910	5 430	470	630	22360R	22360RK	336	584	6	0.32	2.09	3.10	2.04	289	284

[Remark] Standard cage types used for the above bearings are shown in Table 5 earlier in this section.

Spherical roller bearings

d 320 ~ (360) mm

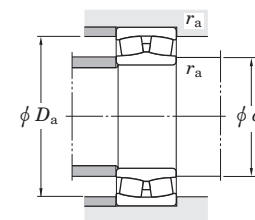
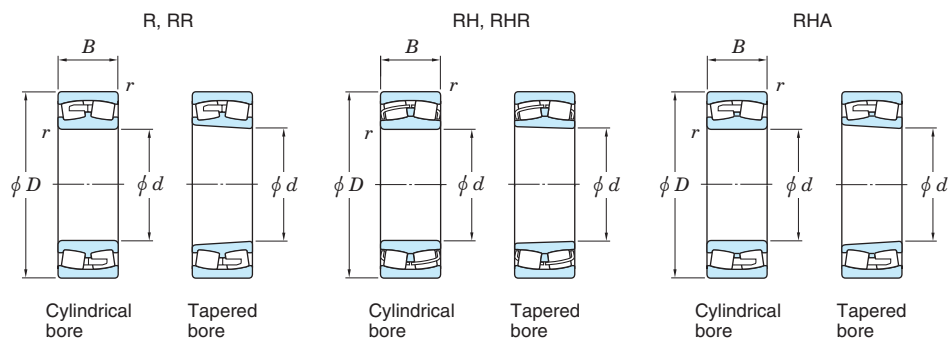

Boundary dimensions (mm)				Basic load ratings (kN)		Limiting speeds (min <sup>-1</sup> )		Bearing No.		Mounting dimensions (mm)			Constant e	Axial load factors			(Refer.) Mass (kg)	
d	D	B	r <sub>min.</sub>	C <sub>r</sub>	C <sub>0r</sub>	Grease lub.	Oil lub.	Cylindrical bore	Tapered bore	d <sub>a</sub> min.	D <sub>a</sub> max.	r <sub>a</sub> max.		Y <sub>1</sub>	Y <sub>2</sub>	Y <sub>0</sub>	Cylindrical bore	Tapered bore
320	440	90	3	1 330	2 870	630	840	23964R	23964RK	334	426	2.5	0.19	3.61	5.38	3.53	43.0	41.7
	480	121	4	1 830	3 740	590	790	23064R	23064RK	338	462	3	0.24	2.76	4.11	2.70	81.2	78.8
	480	121	4	1 980	3 850	590	780	23064RHA	23064RHAK	338	462	3	0.24	2.87	4.27	2.80	74.5	72.1
	480	160	4	2 400	4 920	590	790	24064RR	24064RRK30	338	462	3	0.31	2.16	3.22	2.11	105	103
	480	160	4	2 510	5 230	590	790	24064RHA	24064RHAK30	338	462	3	0.31	2.21	3.29	2.16	93.4	91.4
	540	176	5	2 900	5 700	530	700	23164R	23164RK	342	518	4	0.33	2.04	3.04	2.00	171	166
	540	176	5	3 220	5 960	530	700	23164RHA	23164RHAK	342	518	4	0.32	2.13	3.17	2.08	160	155
	540	218	5	3 730	6 950	530	710	24164RR	24164RRK30	342	518	4	0.39	1.72	2.56	1.68	208	205
	540	218	5	3 760	7 190	530	710	24164RHA	24164RHAK30	342	518	4	0.40	1.70	2.52	1.66	199	196
	580	150	5	2 730	4 540	490	660	22264R	22264RK	342	558	4	0.28	2.41	3.59	2.35	175	171
	580	208	5	3 630	6 550	500	670	23264R	23264RK	342	558	4	0.38	1.76	2.62	1.72	249	242
	580	208	5	4 010	7 030	490	650	23264RHA	23264RHAK	342	558	4	0.36	1.90	2.83	1.86	236	229
340	460	90	3	1 350	2 980	590	790	23968R	23968RK	354	446	2.5	0.18	3.82	5.69	3.74	45.0	43.6
	520	133	5	2 130	4 330	530	710	23068R	23068RK	362	498	4	0.25	2.69	4.00	2.63	108	105
	520	133	5	2 330	4 470	530	710	23068RHA	23068RHAK	362	498	4	0.24	2.80	4.18	2.74	98.7	95.7
	520	180	5	2 920	5 970	530	710	24068RR	24068RRK30	362	498	4	0.33	2.06	3.06	2.01	142	140
	520	180	5	3 040	6 330	530	710	24068RHA	24068RHAK30	362	498	4	0.32	2.11	3.14	2.06	130	128
	580	190	5	3 280	6 430	480	640	23168R	23168RK	362	558	4	0.34	1.97	2.93	1.93	216	210
	580	190	5	3 680	6 720	480	640	23168RHA	23168RHAK	362	558	4	0.32	2.11	3.14	2.06	202	196
	580	243	5	4 440	8 400	490	650	24168RR	24168RRK30	362	558	4	0.41	1.64	2.45	1.61	270	266
	580	243	5	4 540	8 810	490	650	24168RHA	24168RHAK30	362	558	4	0.42	1.61	2.39	1.57	259	255
	620	165	6	3 550	5 430	440	590	22268R	22268RK	368	592	5	0.28	2.43	3.61	2.37	221	216
	620	224	6	4 090	7 560	450	600	23268R	23268RK	368	592	5	0.38	1.77	2.63	1.73	306	297
	620	224	6	4 550	8 030	440	590	23268RHA	23268RHAK	368	592	5	0.36	1.88	2.81	1.84	290	281
360	480	90	3	1 360	3 060	550	730	23972R	23972RK	374	466	2.5	0.17	3.95	5.88	3.86	46.5	45.0
	540	134	5	2 280	4 800	500	660	23072R	23072RK	382	518	4	0.24	2.76	4.11	2.70	115	111
	540	134	5	2 420	4 770	500	660	23072RHA	23072RHAK	382	518	4	0.23	2.92	4.34	2.85	105	101
	540	180	5	3 030	6 300	500	660	24072RR	24072RRK30	382	518	4	0.31	2.15	3.21	2.11	149	147
	540	180	5	3 120	6 620	500	660	24072RHA	24072RHAK30	382	518	4	0.30	2.22	3.30	2.17	135	133

[Remark] Standard cage types used for the above bearings are shown in Table 5 earlier in this section.

Spherical roller bearings

d (360) ~ (400) mm

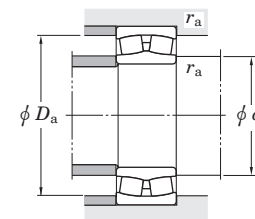
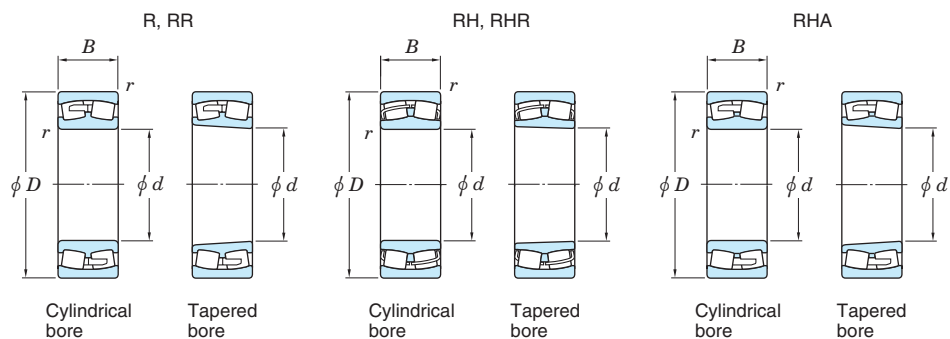

Boundary dimensions (mm)				Basic load ratings (kN)		Limiting speeds (min <sup>-1</sup> )		Bearing No.		Mounting dimensions (mm)			Constant e	Axial load factors			(Refer.) Mass (kg)	
d	D	B	r <sub>min.</sub>	C <sub>r</sub>	C <sub>0r</sub>	Grease lub.	Oil lub.	Cylindrical bore	Tapered bore	d <sub>a</sub> min.	D <sub>a</sub> max.	r <sub>a</sub> max.		Y <sub>1</sub>	Y <sub>2</sub>	Y <sub>0</sub>	Cylindrical bore	Tapered bore
360	600	192	5	3 770	7 040	440	590	23172R	23172RK	382	578	4	0.33	2.07	3.09	2.03	228	221
	600	192	5	3 850	7 210	450	590	23172RHA	23172RHAK	382	578	4	0.31	2.19	3.25	2.14	213	206
	600	243	5	4 080	7 690	450	600	24172R	24172RK30	382	578	4	0.39	1.74	2.59	1.70	287	283
	600	243	5	4 600	9 180	460	610	24172RHA	24172RHAK30	382	578	4	0.40	1.69	2.51	1.65	274	270
	650	170	6	3 770	5 830	410	550	22272R	22272RK	388	622	5	0.27	2.47	3.68	2.42	248	243
	650	232	6	4 850	8 810	410	540	23272R	23272RK	388	622	5	0.37	1.83	2.72	1.79	346	336
	650	232	6	4 960	9 050	410	550	23272RHA	23272RHAK	388	622	5	0.35	1.92	2.85	1.87	328	318
380	520	106	4	1 780	3 940	500	660	23976R	23976RK	398	502	3	0.19	3.62	5.39	3.54	70.0	67.9
	560	135	5	2 320	4 970	470	630	23076R	23076RK	402	538	4	0.24	2.79	4.16	2.73	122	118
	560	135	5	2 520	5 080	460	620	23076RHA	23076RHAK	402	538	4	0.22	3.03	4.51	2.96	112	108
	560	180	5	3 110	6 590	470	620	24076RR	24076RRK30	402	538	4	0.30	2.26	3.36	2.21	156	154
	560	180	5	3 190	6 910	470	620	24076RHA	24076RHAK30	402	538	4	0.29	2.32	3.45	2.27	142	139
	620	194	5	3 590	7 320	420	560	23176R	23176RK	402	598	4	0.31	2.18	3.24	2.13	240	233
	620	194	5	4 000	7 700	420	560	23176RHA	23176RHAK	402	598	4	0.30	2.26	3.36	2.21	224	217
	620	243	5	4 220	8 220	430	570	24176R	24176RK30	402	598	4	0.38	1.78	2.65	1.74	302	297
	620	243	5	4 830	9 840	420	560	24176RHA	24176RHAK30	402	598	4	0.38	1.78	2.65	1.74	288	283
	680	240	6	5 200	9 500	380	500	23276R	23276RK	408	652	5	0.36	1.85	2.76	1.81	386	375
680	240	6	5 320	9 760	380	510	23276RHA	23276RHAK	408	652	5	0.35	1.94	2.89	1.90	365	354	
400	540	106	4	1 880	4 300	470	620	23980R	23980RK	418	522	3	0.18	3.76	5.59	3.67	73.0	70.7
	600	148	5	2 710	5 790	420	560	23080R	23080RK	422	578	4	0.24	2.84	4.23	2.78	155	151
	600	148	5	2 930	5 860	420	560	23080RHA	23080RHAK	422	578	4	0.23	2.94	4.37	2.87	142	138
	600	200	5	3 830	8 110	430	570	24080R	24080RK30	422	578	4	0.32	2.09	3.12	2.05	206	203
	600	200	5	3 780	8 140	420	570	24080RHA	24080RHAK30	422	578	4	0.31	2.21	3.29	2.16	192	189
	650	200	6	4 110	7 780	390	520	23180R	23180RK	428	622	5	0.31	2.19	3.25	2.14	273	265
	650	200	6	4 310	8 300	390	520	23180RHA	23180RHAK	428	622	5	0.29	2.30	3.43	2.25	255	247
	650	250	6	4 640	9 140	390	530	24180R	24180RK30	428	622	5	0.37	1.82	2.70	1.78	338	333
	650	250	6	5 180	10 600	390	520	24180RHA	24180RHAK30	428	622	5	0.37	1.82	2.71	1.78	322	317
	720	256	6	5 210	9 850	350	470	23280R	23280RK	428	692	5	0.37	1.80	2.69	1.76	468	454

[Remark] Standard cage types used for the above bearings are shown in Table 5 earlier in this section.

Spherical roller bearings

d (400) ~ (460) mm

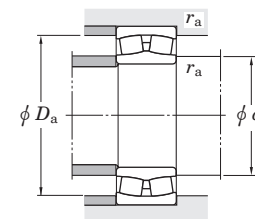
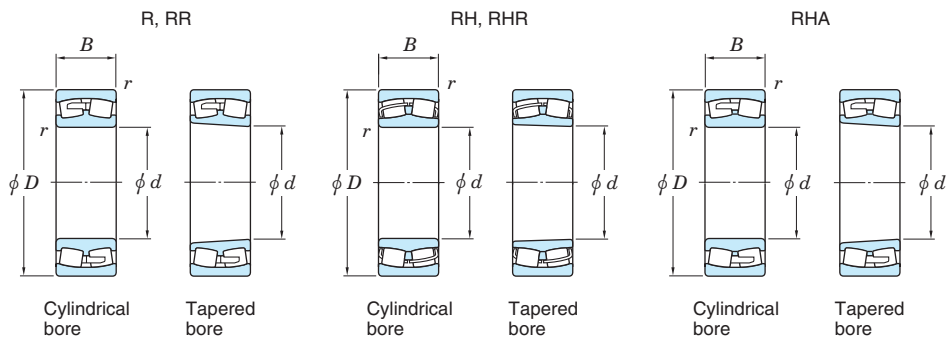

Boundary dimensions (mm)				Basic load ratings (kN)		Limiting speeds (min <sup>-1</sup> )		Bearing No.		Mounting dimensions (mm)			Constant e	Axial load factors			(Refer.) Mass (kg)	
d	D	B	r <sub>min.</sub>	C <sub>r</sub>	C <sub>0r</sub>	Grease lub.	Oil lub.	Cylindrical bore	Tapered bore	d <sub>a min.</sub>	D <sub>a max.</sub>	r <sub>a max.</sub>		Y <sub>1</sub>	Y <sub>2</sub>	Y <sub>0</sub>	Cylindrical bore	Tapered bore
<b>400</b>	720	256	6	5 850	10 600	350	460	<b>23280RHA</b>	<b>23280RHAK</b>	428	692	5	0.35	1.92	2.86	1.88	441	427
<b>420</b>	560	106	4	1 880	4 320	430	580	<b>23984R</b>	<b>23984RK</b>	438	542	3	0.17	3.91	5.82	3.82	76.0	73.6
	620	150	5	2 800	6 120	400	530	<b>23084R</b>	<b>23084RK</b>	442	598	4	0.23	2.90	4.31	2.83	164	159
	620	150	5	3 050	6 230	400	530	<b>23084RHA</b>	<b>23084RHAK</b>	442	598	4	0.22	3.02	4.49	2.95	150	145
	620	200	5	3 590	7 600	400	530	<b>24084R</b>	<b>24084RK30</b>	442	598	4	0.30	2.23	3.32	2.18	212	209
	620	200	5	3 870	8 490	400	530	<b>24084RHA</b>	<b>24084RHAK30</b>	442	598	4	0.29	2.31	3.44	2.26	198	195
	700	224	6	4 470	9 110	350	470	<b>23184R</b>	<b>23184RK</b>	448	672	5	0.33	2.03	3.02	1.98	363	352
	700	224	6	5 040	9 630	350	470	<b>23184RHA</b>	<b>23184RHAK</b>	448	672	5	0.31	2.19	3.25	2.14	339	328
	700	280	6	5 450	10 600	360	480	<b>24184R</b>	<b>24184RK30</b>	448	672	5	0.40	1.71	2.54	1.67	445	438
	700	280	6	6 120	12 400	350	470	<b>24184RHA</b>	<b>24184RHAK30</b>	448	672	5	0.39	1.72	2.56	1.68	425	418
	760	272	7.5	6 500	11 500	320	430	<b>23284R</b>	<b>23284RK</b>	456	724	6	0.37	1.84	2.74	1.80	556	540
	760	272	7.5	6 580	11 900	320	430	<b>23284RHA</b>	<b>23284RHAK</b>	456	724	6	0.36	1.90	2.83	1.86	525	508
<b>440</b>	600	118	4	2 330	5 330	400	530	<b>23988R</b>	<b>23988RK</b>	458	582	3	0.18	3.75	5.58	3.66	101	97.8
	650	157	6	3 030	6 540	370	500	<b>23088R</b>	<b>23088RK</b>	468	622	5	0.24	2.76	4.11	2.70	188	183
	650	157	6	3 370	6 910	370	490	<b>23088RHA</b>	<b>23088RHAK</b>	468	622	5	0.22	3.04	4.53	2.97	172	167
	650	212	6	3 910	8 320	370	490	<b>24088R</b>	<b>24088RK30</b>	468	622	5	0.29	2.35	3.50	2.30	247	243
	650	212	6	4 330	9 560	370	490	<b>24088RHA</b>	<b>24088RHAK30</b>	468	622	5	0.30	2.28	3.39	2.23	231	227
	720	226	6	5 040	9 600	330	440	<b>23188R</b>	<b>23188RK</b>	468	692	5	0.33	2.08	3.09	2.03	378	366
	720	226	6	5 250	10 300	330	440	<b>23188RHA</b>	<b>23188RHAK</b>	468	692	5	0.30	2.25	3.34	2.20	353	341
	720	280	6	5 640	11 200	340	450	<b>24188R</b>	<b>24188RK30</b>	468	692	5	0.38	1.76	2.62	1.72	460	453
	720	280	6	6 200	12 900	330	440	<b>24188RHA</b>	<b>24188RHAK30</b>	468	692	5	0.38	1.79	2.67	1.75	439	432
	790	280	7.5	6 860	12 300	300	400	<b>23288R</b>	<b>23288RK</b>	476	754	6	0.36	1.86	2.77	1.82	613	595
	790	280	7.5	6 930	12 700	300	390	<b>23288RHA</b>	<b>23288RHAK</b>	476	754	6	0.35	1.93	2.88	1.89	580	562
<b>460</b>	620	118	4	2 330	5 350	370	500	<b>23992R</b>	<b>23992RK</b>	478	602	3	0.17	3.89	5.79	3.80	107	104
	680	163	6	3 240	7 170	340	460	<b>23092R</b>	<b>23092RK</b>	488	652	5	0.23	2.92	4.34	2.85	215	209
	680	163	6	3 600	7 430	340	460	<b>23092RHA</b>	<b>23092RHAK</b>	488	652	5	0.22	3.04	4.53	2.97	197	191
	680	218	6	4 570	10 100	340	460	<b>24092R</b>	<b>24092RK30</b>	488	652	5	0.30	2.23	3.32	2.18	277	272

[Remark] Standard cage types used for the above bearings are shown in Table 5 earlier in this section.



Spherical roller bearings

$d$  (460) ~ 500 mm

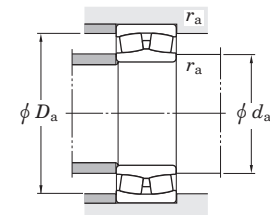
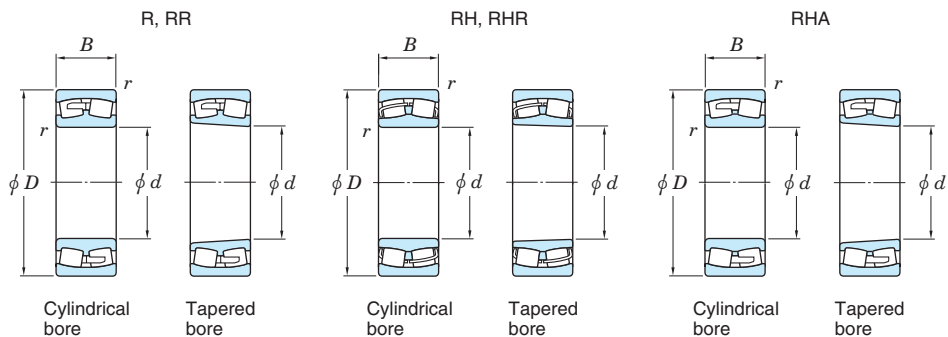

Boundary dimensions (mm)				Basic load ratings (kN)		Limiting speeds (min <sup>-1</sup> )		Bearing No.		Mounting dimensions (mm)			Constant $e$	Axial load factors			(Refer.) Mass (kg)	
$d$	$D$	$B$	$r_{min.}$	$C_r$	$C_{0r}$	Grease lub.	Oil lub.	Cylindrical bore	Tapered bore	$d_a$ min.	$D_a$ max.	$r_a$ max.		$Y_1$	$Y_2$	$Y_0$	Cylindrical bore	Tapered bore
460	680	218	6	4 640	10 300	340	460	24092RHA	24092RHA30	488	652	5	0.29	2.33	3.46	2.27	259	254
	760	240	7.5	5 180	10 800	310	410	23192R	23192RK	496	724	6	0.33	2.07	3.09	2.03	450	436
	760	240	7.5	5 760	11 200	300	400	23192RHA	23192RHA30	496	724	6	0.30	2.22	3.31	2.17	420	406
	760	300	7.5	6 040	12 200	310	410	24192R	24192RK30	496	724	6	0.35	1.95	2.90	1.91	550	541
	760	300	7.5	6 920	14 200	310	410	24192RHA	24192RHA30	496	724	6	0.38	1.75	2.61	1.72	525	516
	830	296	7.5	7 610	13 700	270	370	23292R	23292RK	496	794	6	0.36	1.85	2.76	1.81	720	699
	830	296	7.5	7 670	14 200	270	360	23292RHA	23292RHA30	496	794	6	0.35	1.92	2.85	1.87	679	658
	480	650	128	5	2 630	6 130	350	460	23996R	23996RK	502	628	4	0.18	3.75	5.59	3.67	123
700		165	6	3 350	7 540	320	430	23096R	23096RK	508	672	5	0.22	3.01	4.47	2.94	225	218
700		165	6	3 730	7 860	320	430	23096RHA	23096RHA30	508	672	5	0.22	3.12	4.64	3.05	206	199
700		218	6	4 420	9 650	320	430	24096R	24096RK30	508	672	5	0.29	2.32	3.45	2.26	287	282
700		218	6	4 750	10 700	320	430	24096RHA	24096RHA30	508	672	5	0.28	2.41	3.59	2.35	268	263
790		248	7.5	5 440	11 500	280	380	23196R	23196RK	516	754	6	0.32	2.09	3.12	2.05	503	488
790		248	7.5	6 160	12 000	280	380	23196RHA	23196RHA30	516	754	6	0.30	2.24	3.34	2.19	470	455
790		308	7.5	7 190	14 800	280	380	24196R	24196RK30	516	754	6	0.39	1.74	2.59	1.70	606	597
790		308	7.5	7 360	15 200	290	380	24196RHA	24196RHA30	516	754	6	0.38	1.78	2.65	1.74	580	568
870		310	7.5	8 380	15 100	250	340	23296R	23296RK	516	834	6	0.36	1.85	2.75	1.81	831	807
870		310	7.5	8 450	15 700	250	340	23296RHA	23296RHA30	516	834	6	0.35	1.91	2.85	1.87	785	761
500	670	128	5	2 670	6 310	330	440	239/500R	239/500RK	522	648	4	0.17	3.87	5.76	3.79	131	127
	720	167	6	3 580	8 090	310	410	230/500R	230/500RK	528	692	5	0.23	2.94	4.37	2.87	235	228
	720	218	6	4 600	10 300	310	410	240/500R	240/500RK30	528	692	5	0.28	2.39	3.56	2.34	297	292
	830	264	7.5	6 160	13 000	260	350	231/500R	231/500RK	536	794	6	0.33	2.05	3.05	2.00	595	577
	830	325	7.5	7 710	15 900	260	350	241/500R	241/500RK30	536	794	6	0.36	1.85	2.76	1.81	712	701
	920	336	7.5	8 770	16 700	230	310	232/500R	232/500RK	536	884	6	0.39	1.74	2.59	1.70	1 020	992

[Remark] Standard cage types used for the above bearings are shown in Table 5 earlier in this section.



Adapter assemblies for spherical roller bearings

$d_1$  20 ~ 65 mm

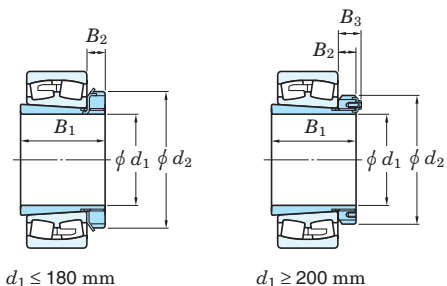

$d_1$  70 ~ 110 mm

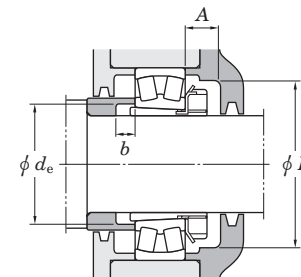

Boundary dimensions (mm)					Brg. bore $d$ (mm)	Designations Bearing + adapter ass'y	Mounting dimensions (mm)				Mass Brg.+adapter ass'y (kg)	(Refer.)	
$d_1$	$B_1$	$d_2$	$B_2$	$B_3$			A min.	K min.	$d_e$ min.	$b$ min.		Adapter sleeve No.	Locknut No.
20	29	38	8	—	25	22205RHRK+H305X	15	45	29	5	0.269	A305X	AN05
25	31	45	8	—	30	22206RHRK+H306X	15	50	34	5	0.404	A306X	AN06
	31	45	8	—	30	21306RHK+H306X	15	50	34	6	0.538	A306X	AN06
30	35	52	9	—	35	22207RHRK+H307X	17	58	39	5	0.610	A307X	AN07
	35	52	9	—	35	21307RHK+H307X	17	58	39	7	0.725	A307X	AN07
35	36	58	10	—	40	22208RHRK+H308X	17	65	44	5	0.793	A308X	AN08
	36	58	10	—	40	21308RHK+H308X	17	65	44	5	0.972	A308X	AN08
	46	58	10	—	40	22308RHRK+H2308X	17	65	45	5	1.30	A2308X	AN08
40	39	65	11	—	45	22209RHRK+H309X	17	72	49	8	0.855	A309X	AN09
	39	65	11	—	45	21309RHK+H309X	17	72	49	5	1.31	A309X	AN09
	50	65	11	—	45	22309RHRK+H2309X	17	72	50	5	1.70	A2309X	AN09
45	42	70	12	—	50	22210RHRK+H310X	19	76	54	10	0.953	A310X	AN10
	42	70	12	—	50	21310RHK+H310X	19	76	54	5	1.67	A310X	AN10
	55	70	12	—	50	22310RHRK+H2310X	19	76	56	5	2.26	A2310X	AN10
50	45	75	12	—	55	22211RHRK+H311X	19	85	60	11	1.22	A311X	AN11
	45	75	12	—	55	21311RHK+H311X	19	85	60	6	2.04	A311X	AN11
	59	75	12	—	55	22311RHRK+H2311X	19	85	61	6	2.80	A2311X	AN11
55	47	80	13	—	60	22212RHRK+H312X	20	90	65	9	1.59	A312X	AN12
	47	80	13	—	60	21312RHK+H312X	20	90	65	5	2.50	A312X	AN12
	62	80	13	—	60	22312RHRK+H2312X	20	90	66	5	3.50	A2312X	AN12
60	50	85	14	—	65	22213RHRK+H313X	21	96	70	8	2.01	A313X	AN13
	50	85	14	—	65	21313RHK+H313X	21	96	70	5	3.07	A313X	AN13
	65	85	14	—	65	22313RHRK+H2313X	21	96	72	5	4.17	A2313X	AN13
65	55	98	15	—	75	22215RHRK+H315X	23	110	80	12	2.58	A315X	AN15
	55	98	15	—	75	21315RHK+H315X	23	110	80	5	4.65	A315X	AN15
	73	98	15	—	75	22315RHRK+H2315X	23	110	82	5	6.44	A2315X	AN15

Boundary dimensions (mm)					Brg. bore $d$ (mm)	Designations Bearing + adapter ass'y	Mounting dimensions (mm)				Mass Brg.+adapter ass'y (kg)	(Refer.)	
$d_1$	$B_1$	$d_2$	$B_2$	$B_3$			A min.	K min.	$d_e$ min.	$b$ min.		Adapter sleeve No.	Locknut No.
70	59	105	17	—	80	22216RHRK+H316X	25	120	86	12	3.22	A316X	AN16
	59	105	17	—	80	21316RHK+H316X	25	120	86	5	5.56	A316X	AN16
	78	105	17	—	80	22316RHRK+H2316X	25	120	87	5	7.64	A2316X	AN16
75	63	110	18	—	85	22217RHRK+H317X	27	128	91	12	3.93	A317X	AN17
	63	110	18	—	85	21317RHK+H317X	27	128	91	6	6.49	A317X	AN17
	82	110	18	—	85	22317RHRK+H2317X	27	128	94	6	8.83	A2317X	AN17
80	65	120	18	—	90	22218RHRK+H318X	28	139	96	10	4.88	A318X	AN18
	86	120	18	—	90	23218RHK+H2318X	28	139	99	18	6.20	A2318X	AN18
	65	120	18	—	90	21318RHK+H318X	28	139	96	6	7.56	A318X	AN18
	86	120	18	—	90	22318RHRK+H2318X	28	139	99	6	10.3	A2318X	AN18
85	68	125	19	—	95	22219RHRK+H319X	29	145	102	9	5.77	A319X	AN19
	68	125	19	—	95	21319RHK+H319X	29	145	102	7	8.68	A319X	AN19
	90	125	19	—	95	22319RHRK+H2319X	29	145	105	7	12.0	A2319X	AN19
90	71	130	20	—	100	22220RHRK+H320X	30	150	107	8	6.80	A320X	AN20
	97	130	20	—	100	23220RHK+H2320X	30	150	110	19	8.94	A2320X	AN20
	71	130	20	—	100	21320RHK+H320X	30	150	107	7	10.5	A320X	AN20
	97	130	20	—	100	22320RHRK+H2320X	30	150	110	7	15.2	A2320X	AN20
100	81	145	21	—	110	23122RHK+H3122X	32	170	117	7	7.91	A3122X	AN22
	77	145	21	—	110	22222RHRK+H3222X	32	170	117	6	9.50	A322X	AN22
	105	145	21	—	110	23222RHK+H2322X	32	170	121	17	12.4	A2322X	AN22
	77	145	21	—	110	21322RHK+H3222X	32	170	117	9	14.0	A322X	AN22
	105	145	21	—	110	22322RHRK+H2322X	32	170	121	7	20.6	A2322X	AN22
	77	145	21	—	110	21322RHK+H3222X	32	170	117	9	14.0	A322X	AN22
110	72	145	22	—	120	23024RHK+H3024X	33	180	127	7	6.12	A3024	ANL24
	88	155	22	—	120	23124RHK+H3124X	33	180	128	7	10.5	A3124	AN24
	88	155	22	—	120	22224RHRK+H3124X	33	180	128	11	11.9	A3124	AN24
	112	155	22	—	120	23224RHK+H2324X	33	180	131	17	15.1	A2324	AN24
	112	155	22	—	120	22324RHRK+H2324X	33	180	131	7	25.6	A2324	AN24
	112	155	22	—	120	21324RHK+H3124X	33	180	128	11	11.9	A3124	AN24

Adapter assemblies for spherical roller bearings

$d_1$  115 ~ (150) mm

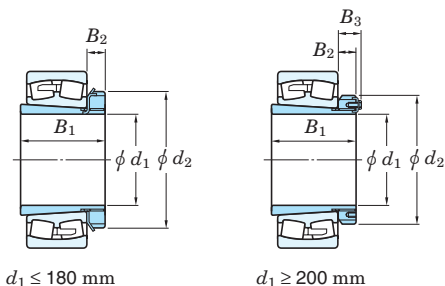

$d_1$  (150) ~ (180) mm

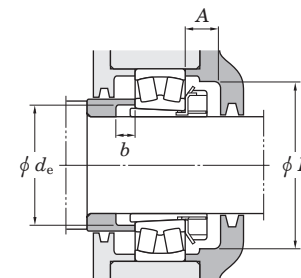

Boundary dimensions (mm)					Brg. bore $d$ (mm)	Designations Bearing + adapter ass'y	Mounting dimensions (mm)				Mass Brg.+adapter ass'y (kg)	(Refer.)	
$d_1$	$B_1$	$d_2$	$B_2$	$B_3$			A min.	K min.	$d_e$ min.	$b$ min.		Adapter sleeve No.	Locknut No.
<b>115</b>	80	155	23	—	130	23026RHK+H3026	34	190	137	8	9.01	A3026	ANL26
	92	165	23	—	130	23126RHK+H3126	34	190	138	8	12.3	A3126	AN26
	92	165	23	—	130	22226RHRK+H3126	34	190	138	8	15.1	A3126	AN26
	121	165	23	—	130	23226RHK+H2326	34	190	142	21	18.8	A2326	AN26
	121	165	23	—	130	22326RHRK+H2326	34	190	142	8	32.7	A2326	AN26
	<b>125</b>	82	165	24	—	140	23028RHK+H3028	36	205	147	8	9.79	A3028
97		180	24	—	140	23128RHK+H3128	36	205	149	8	14.9	A3128	AN28
97		180	24	—	140	22228RHRK+H3128	36	205	149	8	18.8	A3128	AN28
131		180	24	—	140	23228RHK+H2328	36	205	152	22	24.3	A2328	AN28
131		180	24	—	140	22328RHK+H2328	36	205	152	8	40.8	A2328	AN28
<b>135</b>		87	180	26	—	150	23030RHK+H3030	37	220	158	8	11.9	A3030
	111	195	26	—	150	23130RHK+H3130	37	220	160	8	21.7	A3130	AN30
	111	195	26	—	150	22230RHRK+H3130	37	220	160	15	24.3	A3130	AN30
	139	195	26	—	150	23230RHK+H2330	37	220	163	20	30.8	A2330	AN30
	139	195	26	—	150	22330RK+H2330	37	220	163	8	49.7	A2330	AN30
	139	195	26	—	150	22330RHAK+H2330	37	220	163	8	46.4	A2330	AN30
<b>140</b>	93	190	28	—	160	23032RHK+H3032	39	230	168	8	15.0	A3032	ANL32
	119	210	28	—	160	23132RHK+H3132	39	230	170	8	27.9	A3132	AN32
	119	210	28	—	160	22232RK+H3132	39	230	170	14	30.6	A3132	AN32
	119	210	28	—	160	22232RHAK+H3132	39	230	170	14	29.1	A3132	AN32
	147	210	28	—	160	23232RK+H2332	39	230	174	18	39.6	A2332	AN32
	147	210	28	—	160	23232RHAK+H2332	39	230	174	18	38.0	A2332	AN32
	147	210	28	—	160	22332RK+H2332	39	230	174	8	60.5	A2332	AN32
	147	210	28	—	160	22332RHAK+H2332	39	230	174	8	56.6	A2332	AN32
	<b>150</b>	101	200	29	—	170	23034RHK+H3034	40	250	179	8	19.2	A3034
122		220	29	—	170	23134RHK+H3134	40	250	180	8	30.0	A3134	AN34
122		220	29	—	170	22234RK+H3134	40	250	180	10	37.2	A3134	AN34
122		220	29	—	170	22234RHAK+H3134	40	250	180	10	35.3	A3134	AN34

Boundary dimensions (mm)					Brg. bore $d$ (mm)	Designations Bearing + adapter ass'y	Mounting dimensions (mm)				Mass Brg.+adapter ass'y (kg)	(Refer.)		
$d_1$	$B_1$	$d_2$	$B_2$	$B_3$			A min.	K min.	$d_e$ min.	$b$ min.		Adapter sleeve No.	Locknut No.	
<b>150</b>	154	220	29	—	170	23234RK+H2334	40	250	185	18	47.2	A2334	AN34	
	154	220	29	—	170	23234RHAK+H2334	40	250	185	18	45.3	A2334	AN34	
	154	220	29	—	170	22334RK+H2334	40	250	185	8	71.5	A2334	AN34	
	154	220	29	—	170	22334RHAK+H2334	40	250	185	8	66.8	A2334	AN34	
<b>160</b>	109	210	30	—	180	23036RHK+H3036	41	260	189	8	24.2	A3036	ANL36	
	131	230	30	—	180	23136RK+H3136	41	260	191	8	37.1	A3136	AN36	
	131	230	30	—	180	23136RHAK+H3136	41	260	191	8	35.2	A3136	AN36	
	131	230	30	—	180	22236RK+H3136	41	260	191	18	39.4	A3136	AN36	
	131	230	30	—	180	22236RHAK+H3136	41	260	191	18	37.4	A3136	AN36	
	161	230	30	—	180	23236RK+H2336	41	260	195	22	50.5	A2336	AN36	
	161	230	30	—	180	23236RHAK+H2336	41	260	195	22	48.4	A2336	AN36	
	161	230	30	—	180	22336RK+H2336	41	260	195	8	81.8	A2336	AN36	
	161	230	30	—	180	22336RHAK+H2336	41	260	195	8	76.4	A2336	AN36	
	<b>170</b>	112	220	31	—	190	23038RK+H3038	43	270	199	9	26.1	A3038	ANL38
112		220	31	—	190	23038RHAK+H3038	43	270	199	9	24.5	A3038	ANL38	
141		240	31	—	190	23138RK+H3138	43	270	202	9	45.3	A3138	AN38	
141		240	31	—	190	23138RHAK+H3138	43	270	202	9	43.0	A3138	AN38	
141		240	31	—	190	22238RK+H3138	43	270	202	21	47.5	A3138	AN38	
141		240	31	—	190	22238RHAK+H3138	43	270	202	21	45.0	A3138	AN38	
169		240	31	—	190	23238RK+H2338	43	270	206	21	59.2	A2338	AN38	
169		240	31	—	190	23238RHAK+H2338	43	270	206	21	56.7	A2338	AN38	
169		240	31	—	190	22338RK+H2338	43	270	206	9	95.6	A2338	AN38	
169		240	31	—	190	22338RHAK+H2338	43	270	206	9	89.2	A2338	AN38	
<b>180</b>		120	240	32	—	200	23040RK+H3040	46	280	210	10	32.8	A3040	ANL40
		120	240	32	—	200	23040RHAK+H3040	46	280	210	10	30.7	A3040	ANL40
	150	250	32	—	200	23140RK+H3140	46	280	212	10	54.7	A3140	AN40	
	150	250	32	—	200	23140RHAK+H3140	46	280	212	10	51.8	A3140	AN40	
	150	250	32	—	200	22240RK+H3140	46	280	212	24	56.3	A3140	AN40	
	150	250	32	—	200	22240RHAK+H3140	46	280	212	24	53.3	A3140	AN40	

Adapter assemblies for spherical roller bearings

$d_1$  (180) ~ (240) mm

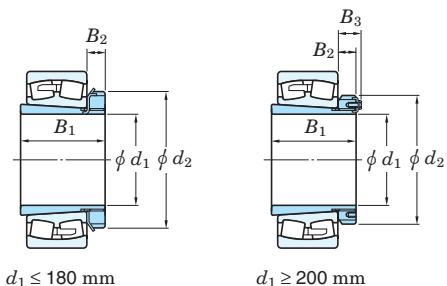

$d_1$  (240) ~ (300) mm

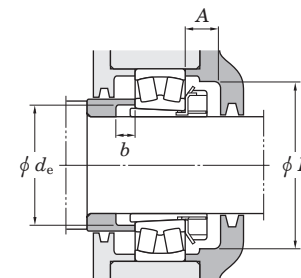

Boundary dimensions (mm)					Brg. bore $d$ (mm)	Designations Bearing + adapter ass'y	Mounting dimensions (mm)				Mass Brg.+adapter ass'y (kg)	(Refer.)		
$d_1$	$B_1$	$d_2$	$B_2$	$B_3$			A min.	K min.	$d_e$ min.	$b$ min.		Adapter sleeve No.	Locknut No.	
<b>180</b>	176	250	32	—	200	23240RK+H2340	46	280	216	20	71.0	A2340	AN40	
	176	250	32	—	200	23240RHAK+H2340	46	280	216	20	68.0	A2340	AN40	
	176	250	32	—	200	22340RK+H2340	46	280	216	10	108	A2340	AN40	
	176	250	32	—	200	22340RHAK+H2340	46	280	216	10	101	A2340	AN40	
<b>200</b>	128	260	30	41	220	23044RK+H3044	—	—	231	12	41.4	A3044	ANL44	
	128	260	30	41	220	23044RHAK+H3044	—	—	231	12	38.7	A3044	ANL44	
	158	280	32	44	220	23144RK+H3144	—	—	233	10	68.4	A3144	AN44	
	158	280	32	44	220	23144RHAK+H3144	—	—	233	10	64.8	A3144	AN44	
	158	280	32	44	220	22244RK+H3144	—	—	233	22	76.9	A3144	AN44	
	158	280	32	44	220	22244RHAK+H3144	—	—	233	22	72.7	A3144	AN44	
	183	280	32	44	220	23244RK+H2344	—	—	236	11	96.5	A2344	AN44	
	183	280	32	44	220	23244RHAK+H2344	—	—	236	11	92.3	A2344	AN44	
	183	280	32	44	220	22344RK+H2344	—	—	236	10	139	A2344	AN44	
	183	280	32	44	220	22344RHAK+H2344	—	—	236	10	130	A2344	AN44	
	<b>220</b>	133	290	34	46	240	23048RK+H3048	—	—	251	11	47.7	A3048	ANL48
		133	290	34	46	240	23048RHAK+H3048	—	—	251	11	44.8	A3048	ANL48
169		300	34	46	240	23148RK+H3148	—	—	254	11	83.6	A3148	AN48	
169		300	34	46	240	23148RHAK+H3148	—	—	254	11	79.1	A3148	AN48	
169		300	34	46	240	22248RK+H3148	—	—	254	19	101	A3148	AN48	
169		300	34	46	240	22248RHAK+H3148	—	—	254	19	95.6	A3148	AN48	
196		300	34	46	240	23248RK+H2348	—	—	257	6	128	A2348	AN48	
196		300	34	46	240	23248RHAK+H2348	—	—	257	6	122	A2348	AN48	
196		300	34	46	240	22348RK+H2348	—	—	257	11	175	A2348	AN48	
196		300	34	46	240	22348RHAK+H2348	—	—	257	11	163	A2348	AN48	
<b>240</b>		147	310	34	46	260	23052RK+H3052	—	—	272	13	65.4	A3052	ANL52
		147	310	34	46	260	23052RHAK+H3052	—	—	272	13	61.0	A3052	ANL52
	187	330	36	49	260	23152RK+H3152	—	—	276	11	114	A3152	AN52	
	187	330	36	49	260	23152RHAK+H3152	—	—	276	11	108	A3152	AN52	

Boundary dimensions (mm)					Brg. bore $d$ (mm)	Designations Bearing + adapter ass'y	Mounting dimensions (mm)				Mass Brg.+adapter ass'y (kg)	(Refer.)		
$d_1$	$B_1$	$d_2$	$B_2$	$B_3$			A min.	K min.	$d_e$ min.	$b$ min.		Adapter sleeve No.	Locknut No.	
<b>240</b>	187	330	36	49	260	22252RK+H3152	—	—	276	25	131	A3152	AN52	
	187	330	36	49	260	22252RHAK+H3152	—	—	276	25	124	A3152	AN52	
	208	330	36	49	260	23252RK+H2352	—	—	278	2	165	A2352	AN52	
	208	330	36	49	260	23252RHAK+H2352	—	—	278	2	158	A2352	AN52	
	208	330	36	49	260	22352RK+H2352	—	—	278	11	217	A2352	AN52	
	208	330	36	49	260	22352RHAK+H2352	—	—	278	11	202	A2352	AN52	
<b>260</b>	152	330	38	50	280	23056RK+H3056	—	—	292	12	71.5	A3056	ANL56	
	152	330	38	50	280	23056RHAK+H3056	—	—	292	12	66.8	A3056	ANL56	
	192	350	38	51	280	23156RK+H3156	—	—	296	12	123	A3156	AN56	
	192	350	38	51	280	23156RHAK+H3156	—	—	296	12	116	A3156	AN56	
	192	350	38	51	280	22256RK+H3156	—	—	296	28	138	A3156	AN56	
	192	350	38	51	280	22256RHAK+H3156	—	—	296	28	130	A3156	AN56	
	221	350	38	51	280	23256RK+H2356	—	—	299	11	178	A2356	AN56	
	221	350	38	51	280	23256RHAK+H2356	—	—	299	11	170	A2356	AN56	
	221	350	38	51	280	22356RK+H2356	—	—	299	12	254	A2356	AN56	
	221	350	38	51	280	22356RHAK+H2356	—	—	299	12	237	A2356	AN56	
	<b>280</b>	168	360	42	54	300	23060RK+H3060	—	—	313	12	97.7	A3060	ANL60
		168	360	42	54	300	23060RHAK+H3060	—	—	313	12	90.8	A3060	ANL60
208		380	40	53	300	23160RK+H3160	—	—	317	12	159	A3160	AN60	
208		380	40	53	300	23160RHAK+H3160	—	—	317	12	150	A3160	AN60	
208		380	40	53	300	22260RK+H3160	—	—	317	32	173	A3160	AN60	
208		380	40	53	300	22260RHAK+H3160	—	—	317	32	163	A3160	AN60	
240		380	40	53	300	23260RK+H3260	—	—	321	12	227	A3260	AN60	
240		380	40	53	300	23260RHAK+H3260	—	—	321	12	217	A3260	AN60	
<b>300</b>		171	380	42	55	320	23064RK+H3064	—	—	334	13	105	A3064	ANL64
		171	380	42	55	320	23064RHAK+H3064	—	—	334	13	98.1	A3064	ANL64
		226	400	42	56	320	23164RK+H3164	—	—	339	13	202	A3164	AN64
		226	400	42	56	320	23164RHAK+H3164	—	—	339	13	191	A3164	AN64
	226	400	42	56	320	22264RK+H3164	—	—	339	39	207	A3164	AN64	

Adapter assemblies for spherical roller bearings

$d_1$  (300) ~ (400) mm

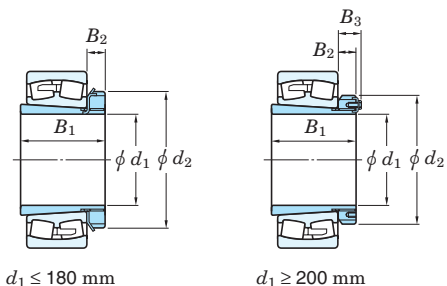

$d_1$  (400) ~ 470 mm

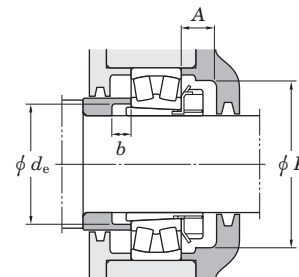

Boundary dimensions (mm)					Brg. bore d (mm)	Designations Bearing + adapter ass'y	Mounting dimensions (mm)				Mass Brg.+adapter ass'y (kg)	(Refer.)	
$d_1$	$B_1$	$d_2$	$B_2$	$B_3$			A min.	K min.	$d_e$ min.	b min.		Adapter sleeve No.	Locknut No.
<b>300</b>	258	400	42	56	320	23264RK+H3264 23264RHAK+H3264	—	—	343	13	283	A3264	AN64
	258	400	42	56	320		—	—	343	13	270	A3264	AN64
<b>320</b>	187	400	45	58	340	23068RK+H3068 23068RHAK+H3068	—	—	355	14	135	A3068	ANL68
	187	400	45	58	340		—	—	355	14	126	A3068	ANL68
	254	440	55	72	340	23168RK+H3168	—	—	360	14	262	A3168	AN68
	254	440	55	72	340	23168RHAK+H3168	—	—	360	14	248	A3168	AN68
	288	440	55	72	340	23268RK+H3268	—	—	364	14	355	A3268	AN68
	288	440	55	72	340	23268RHAK+H3268	—	—	364	14	339	A3268	AN68
<b>340</b>	188	420	45	58	360	23072RK+H3072 23072RHAK+H3072	—	—	375	14	143	A3072	ANL72
	188	420	45	58	360		—	—	375	14	133	A3072	ANL72
	259	460	58	75	360	23172RK+H3172	—	—	380	14	278	A3172	AN72
	259	460	58	75	360	23172RHAK+H3172	—	—	380	14	263	A3172	AN72
	299	460	58	75	360	23272RK+H3272	—	—	385	14	400	A3272	AN72
	299	460	58	75	360	23272RHAK+H3272	—	—	385	14	382	A3272	AN72
<b>360</b>	193	450	48	62	380	23076RK+H3076 23076RHAK+H3076	—	—	396	15	156	A3076	ANL76
	193	450	48	62	380		—	—	396	15	146	A3076	ANL76
	264	490	60	77	380	23176RK+H3176	—	—	401	15	298	A3176	AN76
	264	490	60	77	380	23176RHAK+H3176	—	—	401	15	282	A3176	AN76
	310	490	60	77	380	23276RK+H3276	—	—	405	15	448	A3276	AN76
	310	490	60	77	380	23276RHAK+H3276	—	—	405	15	427	A3276	AN76
<b>380</b>	210	470	52	66	400	23080RK+H3080 23080RHAK+H3080	—	—	417	15	195	A3080	ANL80
	210	470	52	66	400		—	—	417	15	182	A3080	ANL80
	272	520	62	82	400	23180RK+H3180	—	—	421	15	339	A3180	AN80
	272	520	62	82	400	23180RHAK+H3180	—	—	421	15	321	A3180	AN80
	328	520	62	82	400	23280RK+H3280	—	—	427	15	539	A3280	AN80
	328	520	62	82	400	23280RHAK+H3280	—	—	427	15	512	A3280	AN80
<b>400</b>	212	490	52	66	420	23084RK+H3084 23084RHAK+H3084	—	—	437	16	205	A3084	ANL84
	212	490	52	66	420		—	—	437	16	191	A3084	ANL84

Boundary dimensions (mm)					Brg. bore d (mm)	Designations Bearing + adapter ass'y	Mounting dimensions (mm)				Mass Brg.+adapter ass'y (kg)	(Refer.)	
$d_1$	$B_1$	$d_2$	$B_2$	$B_3$			A min.	K min.	$d_e$ min.	b min.		Adapter sleeve No.	Locknut No.
<b>400</b>	304	540	70	90	420	23184RK+H3184 23184RHA+H3184	—	—	443	16	441	A3184	AN84
	304	540	70	90	420		23284RK+H3284	—	—	448	16	417	A3184
	352	540	70	90	420	23284RHAK+H3284	—	—	448	16	639	A3284	AN84
	352	540	70	90	420		—	—	448	16	607	A3284	AN84
<b>410</b>	228	520	60	77	440	23088RK+H3088 23088RHAK+H3088	—	—	458	17	252	A3088	ANL88
	228	520	60	77	440		—	—	458	17	236	A3088	ANL88
	307	560	70	90	440	23188RK+H3188	—	—	464	17	474	A3188	AN88
	307	560	70	90	440	23188RHAK+H3188	—	—	464	17	449	A3188	AN88
	361	560	70	90	440	23288RK+H3288	—	—	469	17	718	A3288	AN88
	361	560	70	90	440	23288RHAK+H3288	—	—	469	17	685	A3288	AN88
<b>430</b>	234	540	60	77	460	23092RK+H3092 23092RHAK+H3092	—	—	478	17	283	A3092	ANL92
	234	540	60	77	460		—	—	478	17	265	A3092	ANL92
	326	580	75	95	460	23192RK+H3192	—	—	485	17	559	A3192	AN92
	326	580	75	95	460	23192RHAK+H3192	—	—	485	17	529	A3192	AN92
	382	580	75	95	460	23292RK+H3292	—	—	491	17	838	A3292	AN92
	382	580	75	95	460	23292RHAK+H3292	—	—	491	17	797	A3292	AN92
<b>450</b>	237	560	60	77	480	23096RK+H3096 23096RHAK+H3096	—	—	499	18	295	A3096	ANL96
	237	560	60	77	480		—	—	499	18	276	A3096	ANL96
	335	620	75	95	480	23196RK+H3196	—	—	505	18	628	A3196	AN96
	335	620	75	95	480	23196RHAK+H3196	—	—	505	18	595	A3196	AN96
	397	620	75	95	480	23296RK+H3296	—	—	512	18	966	A3296	AN96
	397	620	75	95	480	23296RHAK+H3296	—	—	512	18	920	A3296	AN96
<b>470</b>	247	580	68	85	500	230/500RK+H30/500	—	—	519	18	315	A30/500	ANL100
	356	630	80	100	500	231/500RK+H31/500	—	—	527	18	727	A31/500	AN100
	428	630	80	100	500	232/500RK+H32/500	—	—	534	18	1 167	A32/500	AN100

Withdrawal sleeves for spherical roller bearings

$d_1$  35 ~ (75) mm

$d_1$  (75) ~ (115) mm

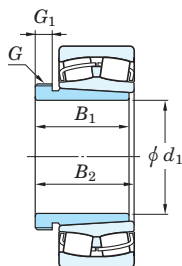

$d_1$	Boundary dimensions (mm)			$G_1$	Brg. bore $d$ (mm)	Designations Bearing + withdrawal sleeve	Mass Brg.+withdrawal sleeve (kg)	(Refer.) Applicable locknut No.
	$B_1$	$B_2$	$G^{1)}$ Screw size					
35	29	32	M45×1.5	6	40	22208RHRK+AH308	0.681	AN09
	29	32	M45×1.5	6	40	21308RHK+AH308	0.860	AN09
	40	43	M45×1.5	7	40	22308RHRK+AH2308	1.19	AN09
40	31	34	M50×1.5	6	45	22209RHRK+AH309	0.699	AN10
	31	34	M50×1.5	6	45	21309RHK+AH309	1.14	AN10
	44	47	M50×1.5	7	45	22309RHRK+AH2309	1.55	AN10
45	35	38	M55×2	7	50	22210RHRK+AHX310	0.771	AN11
	35	38	M55×2	7	50	21310RHK+AHX310	1.49	AN11
	50	53	M55×2	9	50	22310RHRK+AHX2310	2.09	AN11
50	37	40	M60×2	7	55	22211RHRK+AHX311	1.01	AN12
	37	40	M60×2	7	55	21311RHK+AHX311	1.83	AN12
	54	57	M60×2	10	55	22311RHRK+AHX2311	2.60	AN12
55	40	43	M65×2	8	60	22212RHRK+AHX312	1.35	AN13
	40	43	M65×2	8	60	21312RHK+AHX312	2.27	AN13
	58	61	M65×2	11	60	22312RHRK+AHX2312	3.29	AN13
60	42	45	M75×2	8	65	22213RHRK+AH313	1.77	AN15
	42	45	M75×2	8	65	21313RHK+AH313	2.84	AN15
	61	64	M75×2	12	65	22313RHRK+AH2313	3.98	AN15
65	43	47	M80×2	8	70	22214RHRK+AH314	1.89	AN16
	43	47	M80×2	8	70	21314RHK+AH314	3.43	AN16
	64	68	M80×2	12	70	22314RHRK+AHX2314	4.82	AN16
70	45	49	M85×2	8	75	22215RHRK+AH315	2.01	AN17
	45	49	M85×2	8	75	21315RHK+AH315	4.07	AN17
	68	72	M85×2	12	75	22315RHRK+AHX2315	5.87	AN17
75	48	52	M90×2	8	80	22216RHRK+AH316	2.49	AN18
	48	52	M90×2	8	80	21316RHK+AH316	4.83	AN18

$d_1$	Boundary dimensions (mm)			$G_1$	Brg. bore $d$ (mm)	Designations Bearing + withdrawal sleeve	Mass Brg.+withdrawal sleeve (kg)	(Refer.) Applicable locknut No.
	$B_1$	$B_2$	$G^{1)}$ Screw size					
75	71	75	M90×2	12	80	22316RHRK+AHX2316	6.90	AN18
80	52	56	M95×2	9	85	22217RHRK+AHX317	3.12	AN19
	52	56	M95×2	9	85	21317RHK+AHX317	5.68	AN19
	74	78	M95×2	13	85	22317RHRK+AHX2317	7.98	AN19
85	53	57	M100×2	9	90	22218RHRK+AHX318	3.89	AN20
	63	67	M100×2	10	90	23218RHK+AHX3218	5.08	AN20
	53	57	M100×2	9	90	21318RHK+AHX318	6.58	AN20
	79	83	M100×2	14	90	22318RHRK+AHX2318	9.41	AN20
90	57	61	M105×2	10	95	22219RHRK+AHX319	4.68	AN21
	57	61	M105×2	10	95	21319RHK+AHX319	7.59	AN21
	85	89	M105×2	16	95	22319RHRK+AHX2319	10.9	AN21
95	59	63	M110×2	10	100	22220RHRK+AHX320	5.58	AN22
	73	77	M110×2	11	100	23220RHK+AHX3220	7.43	AN22
	59	63	M110×2	10	100	21320RHK+AHX320	9.26	AN22
	90	94	M110×2	16	100	22320RHRK+AHX2320	13.9	AN22
105	68	72	M120×2	11	110	23122RHK+AHX3122	6.30	AN24
	82	91	M115×2	13	110	24122RHK30+AH24122	7.60	AN23
	68	72	M120×2	11	110	22222RHRK+AHX3122	7.97	AN24
	82	86	M125×2	11	110	23222RHK+AHX3222	10.5	AN25
	63	67	M120×2	12	110	21322RHK+AHX322	12.3	AN24
115	98	102	M125×2	16	110	22322RHRK+AHX2322	19.1	AN25
	60	64	M130×2	13	120	23024RHK+AHX3024	4.82	AN26
	73	82	M125×2	13	120	24024RHK30+AH24024	5.99	AN25
	75	79	M130×2	12	120	23124RHK+AHX3124	8.69	AN26
	93	102	M130×2	13	120	24124RHK30+AH24124	11.0	AN26
75	79	M130×2	12	120	22224RHRK+AHX3124	10.1	AN26	

[Note] 1) Basic profile and dimensions of screw thread identified by prefix M are in accordance with JIS B 0205.  
Basic profile and dimensions of screw thread identified by prefix Tr are in accordance with JIS B 0216.



Withdrawal sleeves for spherical roller bearings

$d_1$  (115) ~ (150) mm

$d_1$  (150) ~ 170 mm

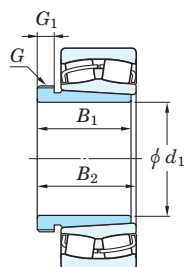

$d_1$	Boundary dimensions (mm)			$G_1$	Brg. bore $d$ (mm)	Designations Bearing + withdrawal sleeve	Mass Brg.+withdrawal sleeve (kg)	(Refer.) Applicable locknut No.
	$B_1$	$B_2$	$G^{1)}$ Screw size					
<b>115</b>	90	94	M135×2	13	120	23224RHK+ <b>AHX3224</b>	13.1	AN27
	105	109	M135×2	17	120	22324RHRK+ <b>AHX2324</b>	23.9	AN27
<b>125</b>	67	71	M140×2	14	130	23026RHK+ <b>AHX3026</b>	6.90	AN28
	83	93	M135×2	14	130	24026RHK30+ <b>AH24026</b>	8.74	AN27
	78	82	M140×2	12	130	23126RHK+ <b>AHX3126</b>	9.52	AN28
	94	104	M140×2	14	130	24126RHK30+ <b>AH24126</b>	11.7	AN28
	78	82	M140×2	12	130	22226RHRK+ <b>AHX3126</b>	12.4	AN28
	98	102	M145×2	15	130	23226RHK+ <b>AHX3226</b>	15.6	AN29
	115	119	M145×2	19	130	22326RHRK+ <b>AHX2326</b>	29.9	AN29
<b>135</b>	68	73	M150×2	14	140	23028RHK+ <b>AHX3028</b>	7.43	AN30
	83	93	M145×2	14	140	24028RHK30+ <b>AH24028</b>	9.26	AN29
	83	88	M150×2	14	140	23128RHK+ <b>AHX3128</b>	11.5	AN30
	99	109	M150×2	14	140	24128RHK30+ <b>AH24128</b>	14.1	AN30
	83	88	M150×2	14	140	22228RHRK+ <b>AHX3128</b>	15.4	AN30
	104	109	M155×3	15	140	23228RHK+ <b>AHX3228</b>	20.3	AN31
	125	130	M155×3	20	140	22328RHK+ <b>AHX2328</b>	35.0	AN31
	<b>145</b>	72	77	M160×3	15	150	23030RHK+ <b>AHX3030</b>	8.92
90		101	M155×3	15	150	24030RHK30+ <b>AH24030</b>	11.4	AN31
96		101	M165×3	15	150	23130RHK+ <b>AHX3130</b>	17.7	AN33
115		126	M160×3	15	150	24130RHK30+ <b>AH24130</b>	21.2	AN32
96		101	M165×3	15	150	22230RHRK+ <b>AHX3130</b>	20.3	AN33
114		119	M165×3	17	150	23230RHK+ <b>AHX3230</b>	26.0	AN33
135		140	M165×3	24	150	22330RK+ <b>AHX2330</b>	45.5	AN33
135		140	M165×3	24	150	22330RHAK+ <b>AHX2330</b>	42.2	AN33
<b>150</b>	77	82	M170×3	16	160	23032RHK+ <b>AH3032</b>	11.5	AN34
	95	106	M170×3	15	160	24032RHK30+ <b>AH24032</b>	15.0	AN34
	103	108	M180×3	16	160	23132RHK+ <b>AH3132</b>	23.4	AN36

$d_1$	Boundary dimensions (mm)			$G_1$	Brg. bore $d$ (mm)	Designations Bearing + withdrawal sleeve	Mass Brg.+withdrawal sleeve (kg)	(Refer.) Applicable locknut No.
	$B_1$	$B_2$	$G^{1)}$ Screw size					
<b>150</b>	103	108	M180×3	16	160	22232RK+ <b>AH3132</b>	26.1	AN36
	103	108	M180×3	16	160	22232RHAK+ <b>AH3132</b>	24.6	AN36
	124	130	M180×3	20	160	23232RK+ <b>AH3232</b>	35.1	AN36
	124	130	M180×3	20	160	23232RHAK+ <b>AH3232</b>	32.6	AN36
	140	146	M180×3	24	160	22332RK+ <b>AH2332</b>	55.7	AN36
	140	146	M180×3	24	160	22332RHAK+ <b>AH2332</b>	51.8	AN36
<b>160</b>	85	90	M180×3	17	170	23034RHK+ <b>AH3034</b>	15.2	AN36
	106	117	M180×3	16	170	24034RHK30+ <b>AH24034</b>	20.0	AN36
	104	109	M190×3	16	170	23134RHK+ <b>AH3134</b>	24.6	AN38
	125	136	M180×3	16	170	24134RRK30+ <b>AH24134</b>	30.0	AN36
	104	109	M190×3	16	170	22234RK+ <b>AH3134</b>	31.8	AN38
	104	109	M190×3	16	170	22234RHAK+ <b>AH3134</b>	29.9	AN38
	134	140	M190×3	24	170	23234RK+ <b>AH3234</b>	42.3	AN38
	134	140	M190×3	24	170	23234RHAK+ <b>AH3234</b>	39.4	AN38
	146	152	M190×3	24	170	22334RK+ <b>AH2334</b>	66.1	AN38
	146	152	M190×3	24	170	22334RHAK+ <b>AH2334</b>	61.4	AN38
<b>170</b>	92	98	M190×3	17	180	23036RHK+ <b>AH3036</b>	19.7	AN38
	116	127	M190×3	16	180	24036RRK30+ <b>AH24036</b>	26.1	AN38
	116	122	M200×3	19	180	23136RK+ <b>AH3136</b>	31.7	AN40
	116	122	M200×3	19	180	23136RHAK+ <b>AH3136</b>	29.8	AN40
	134	145	M190×3	16	180	24136RRK30+ <b>AH24136</b>	37.6	AN38
	134	145	M190×3	16	180	24136RHAK30+ <b>AH24136</b>	34.9	AN38
	105	110	M200×3	17	180	22236RK+ <b>AH2236</b>	33.5	AN40
	105	110	M200×3	17	180	22236RHAK+ <b>AH2236</b>	31.5	AN40
	140	146	M200×3	24	180	23236RK+ <b>AH3236</b>	45.1	AN40
	140	146	M200×3	24	180	23236RHAK+ <b>AH3236</b>	41.8	AN40
	154	160	M200×3	24	180	22336RK+ <b>AH2336</b>	75.7	AN40
	154	160	M200×3	24	180	22336RHAK+ <b>AH2336</b>	70.3	AN40

[Note] 1) Basic profile and dimensions of screw thread identified by prefix M are in accordance with JIS B 0205.  
Basic profile and dimensions of screw thread identified by prefix Tr are in accordance with JIS B 0216.

$d_1$  180 ~ 190 mm

$d_1$  200 ~ 220 mm

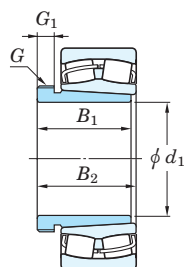

$d_1$	Boundary dimensions (mm)			$G_1$	Brg. bore $d$ (mm)	Designations Bearing + withdrawal sleeve	Mass Brg.+withdrawal sleeve (kg)	(Refer.) Applicable locknut No.
	$B_1$	$B_2$	$G^{1)}$ Screw size					
<b>180</b>	96	102	Tr205×4	18	190	23038RK+ <b>AH3038</b>	21.5	HNL41
	96	102	Tr205×4	18	190	23038RHAK+ <b>AH3038</b>	19.9	HNL41
	118	131	M200×3	18	190	24038RRK30+ <b>AH24038</b>	27.6	AN40
	118	131	M200×3	18	190	24038RHAK30+ <b>AH24038</b>	25.5	AN40
	125	131	Tr210×4	20	190	23138RK+ <b>AH3138</b>	39.3	HN42
	125	131	Tr210×4	20	190	23138RHAK+ <b>AH3138</b>	37.0	HN42
	146	159	M200×3	18	190	24138RRK30+ <b>AH24138</b>	46.7	AN40
	146	159	M200×3	18	190	24138RHAK30+ <b>AH24138</b>	43.8	AN40
	112	117	Tr210×4	18	190	22238RK+ <b>AH2238</b>	40.9	HN42
	112	117	Tr210×4	18	190	22238RHAK+ <b>AH2238</b>	38.4	HN42
	145	152	Tr210×4	25	190	23238RK+ <b>AH3238</b>	53.3	HN42
	145	152	Tr210×4	25	190	23238RHAK+ <b>AH3238</b>	49.4	HN42
	160	167	Tr210×4	26	190	22338RK+ <b>AH2338</b>	89.0	HN42
	160	167	Tr210×4	26	190	22338RHAK+ <b>AH2338</b>	82.6	HN42
<b>190</b>	102	108	Tr215×4	19	200	23040RK+ <b>AH3040</b>	27.2	HNL43
	102	108	Tr215×4	19	200	23040RHAK+ <b>AH3040</b>	25.1	HNL43
	127	140	Tr210×4	18	200	24040RRK30+ <b>AH24040</b>	34.6	HN42
	127	140	Tr210×4	18	200	24040RHAK30+ <b>AH24040</b>	31.9	HN42
	134	140	Tr220×4	21	200	23140RK+ <b>AH3140</b>	47.9	HN44
	134	140	Tr220×4	21	200	23140RHAK+ <b>AH3140</b>	45.0	HN44
	158	171	Tr210×4	18	200	24140RRK30+ <b>AH24140</b>	57.6	HN42
	158	171	Tr210×4	18	200	24140RHAK30+ <b>AH24140</b>	53.8	HN42
	118	123	Tr220×4	19	200	22240RK+ <b>AH2240</b>	48.7	HN44
	118	123	Tr220×4	19	200	22240RHAK+ <b>AH2240</b>	45.7	HN44
	153	160	Tr220×4	25	200	23240RK+ <b>AH3240</b>	64.7	HN44
	153	160	Tr220×4	25	200	23240RHAK+ <b>AH3240</b>	60.1	HN44
	170	177	Tr220×4	26	200	22340RK+ <b>AH2340</b>	101	HN44
	170	177	Tr220×4	26	200	22340RHAK+ <b>AH2340</b>	93.4	HN44

$d_1$	Boundary dimensions (mm)			$G_1$	Brg. bore $d$ (mm)	Designations Bearing + withdrawal sleeve	Mass Brg.+withdrawal sleeve (kg)	(Refer.) Applicable locknut No.
	$B_1$	$B_2$	$G^{1)}$ Screw size					
<b>200</b>	111	117	Tr235×4	20	220	23044RK+ <b>AH3044</b>	38.0	HNL47
	111	117	Tr235×4	20	220	23044RHAK+ <b>AH3044</b>	35.3	HNL47
	138	152	Tr230×4	20	220	24044RRK30+ <b>AH24044</b>	48.1	—
	138	152	Tr230×4	20	220	24044RHAK30+ <b>AH24044</b>	44.7	—
	145	151	Tr240×4	23	220	23144RK+ <b>AH3144</b>	63.6	HN48
	145	151	Tr240×4	23	220	23144RHAK+ <b>AH3144</b>	60.0	HN48
	170	184	Tr230×4	20	220	24144RRK30+ <b>AH24144</b>	76.4	—
	170	184	Tr230×4	20	220	24144RHAK30+ <b>AH24144</b>	71.2	—
	130	136	Tr240×4	20	220	22244RK+ <b>AH2244</b>	70.8	HN48
	130	136	Tr240×4	20	220	22244RHAK+ <b>AH2244</b>	66.6	HN48
	181	189	Tr240×4	30	220	23244RK+ <b>AH2344</b>	95.1	HN48
	181	189	Tr240×4	30	220	23244RHAK+ <b>AH2344</b>	88.5	HN48
	181	189	Tr240×4	30	220	22344RK+ <b>AH2344</b>	136	HN48
	181	189	Tr240×4	30	220	22344RHAK+ <b>AH2344</b>	127	HN48
<b>220</b>	116	123	Tr260×4	21	240	23048RK+ <b>AH3048</b>	42.6	HNL52
	116	123	Tr260×4	21	240	23048RHAK+ <b>AH3048</b>	39.7	HNL52
	138	153	Tr250×4	20	240	24048RRK30+ <b>AH24048</b>	51.9	—
	138	153	Tr250×4	20	240	24048RHAK30+ <b>AH24048</b>	48.0	—
	154	161	Tr260×4	25	240	23148RK+ <b>AH3148</b>	77.6	HN52
	154	161	Tr260×4	25	240	23148RHAK+ <b>AH3148</b>	73.1	HN52
	180	195	Tr260×4	20	240	24148RRK30+ <b>AH24148</b>	94.0	HN52
	180	195	Tr260×4	20	240	24148RHAK30+ <b>AH24148</b>	87.9	HN52
	144	150	Tr260×4	21	240	22248RK+ <b>AH2248</b>	94.3	HN52
	144	150	Tr260×4	21	240	22248RHAK+ <b>AH2248</b>	88.7	HN52
	189	197	Tr260×4	30	240	23248RK+ <b>AH2348</b>	126	HN52
	189	197	Tr260×4	30	240	23248RHAK+ <b>AH2348</b>	117	HN52
	189	197	Tr260×4	30	240	22348RK+ <b>AH2348</b>	170	HN52
	189	197	Tr260×4	30	240	22348RHAK+ <b>AH2348</b>	158	HN52

[Note] 1) Basic profile and dimensions of screw thread identified by prefix M are in accordance with JIS B 0205.  
Basic profile and dimensions of screw thread identified by prefix Tr are in accordance with JIS B 0216.

Withdrawal sleeves for spherical roller bearings

$d_1$  240 ~ 260 mm

$d_1$  280 ~ (320) mm

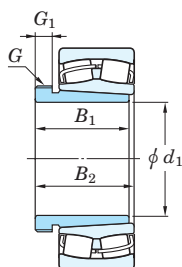

$d_1$	Boundary dimensions (mm)			$G_1$	Brg. bore $d$ (mm)	Designations Bearing + withdrawal sleeve	Mass Brg.+withdrawal sleeve (kg)	(Refer.) Applicable locknut No.
	$B_1$	$B_2$	$G^{1)}$ Screw size					
240	128	135	Tr280×4	23	260	23052RK+AH3052	60.0	HNL56
	128	135	Tr280×4	23	260	23052RHAK+AH3052	55.6	HNL56
	162	178	Tr270×4	22	260	24052RRK30+AH24052	77.0	—
	162	178	Tr270×4	22	260	24052RHAK30+AH24052	71.2	—
	172	179	Tr290×4	26	260	23152RK+AH3152	107	HN58
	172	179	Tr290×4	26	260	23152RHAK+AH3152	101	HN58
	202	218	Tr280×4	22	260	24152RRK30+AH24152	128	—
	202	218	Tr280×4	22	260	24152RHAK30+AH24152	120	—
	155	161	Tr290×4	23	260	22252RK+AH2252	122	HN58
	155	161	Tr290×4	23	260	22252RHAK+AH2252	115	HN58
	205	213	Tr290×4	30	260	23252RK+AH2352	164	HN58
	205	213	Tr290×4	30	260	23252RHAK+AH2352	153	HN58
	205	213	Tr290×4	30	260	22352RK+AH2352	212	HN58
	205	213	Tr290×4	30	260	22352RHAK+AH2352	197	HN58
260	131	139	Tr300×4	24	280	23056RK+AH3056	64.9	HNL60
	131	139	Tr300×4	24	280	23056RHAK+AH3056	60.2	HNL60
	162	179	Tr290×4	22	280	24056RRK30+AH24056	81.9	HN58
	162	179	Tr290×4	22	280	24056RHAK30+AH24056	75.7	HN58
	175	183	Tr310×5	28	280	23156RK+AH3156	114	HN62
	175	183	Tr310×5	28	280	23156RHAK+AH3156	108	HN62
	202	219	Tr300×4	22	280	24156RRK30+AH24156	136	—
	202	219	Tr300×4	22	280	24156RHAK30+AH24156	128	—
	155	163	Tr310×5	24	280	22256RK+AH2256	127	HN62
	155	163	Tr310×5	24	280	22256RHAK+AH2256	119	HN62
	212	220	Tr310×5	30	280	23256RK+AH2356	175	HN62
	212	220	Tr310×5	30	280	23256RHAK+AH2356	163	HN62
	212	220	Tr310×5	30	280	22356RK+AH2356	247	HN62
	212	220	Tr310×5	30	280	22356RHAK+AH2356	230	HN62

$d_1$	Boundary dimensions (mm)			$G_1$	Brg. bore $d$ (mm)	Designations Bearing + withdrawal sleeve	Mass Brg.+withdrawal sleeve (kg)	(Refer.) Applicable locknut No.
	$B_1$	$B_2$	$G^{1)}$ Screw size					
280	145	153	Tr320×5	26	300	23060RK+AH3060	88.1	HNL64
	145	153	Tr320×5	26	300	23060RHAK+AH3060	81.2	HNL64
	184	202	Tr310×5	24	300	24060RRK30+AH24060	112	HN62
	184	202	Tr310×5	24	300	24060RHAK30+AH24060	105	HN62
	192	200	Tr330×5	30	300	23160RK+AH3160	149	HN66
	192	200	Tr330×5	30	300	23160RHAK+AH3160	140	HN66
	224	242	Tr320×5	24	300	24160RRK30+AH24160	180	—
	224	242	Tr320×5	24	300	24160RHAK30+AH24160	168	—
	170	178	Tr330×5	26	300	22260RK+AH2260	160	HN66
	170	178	Tr330×5	26	300	22260RHAK+AH2260	150	HN66
	228	236	Tr330×5	34	300	23260RK+AH3260	223	HN66
	228	236	Tr330×5	34	300	23260RHAK+AH3260	208	HN66
300	149	157	Tr345×5	27	320	23064RK+AH3064	94.8	HNL69
	149	157	Tr345×5	27	320	23064RHAK+AH3064	88.1	HNL69
	184	202	Tr330×5	24	320	24064RRK30+AH24064	120	HN66
	184	202	Tr330×5	24	320	24064RHAK30+AH24064	108	HN66
	209	217	Tr350×5	31	320	23164RK+AH3164	191	HN70
	209	217	Tr350×5	31	320	23164RHAK+AH3164	180	HN70
	242	260	Tr340×5	24	320	24164RRK30+AH24164	226	—
	242	260	Tr340×5	24	320	24164RHAK30+AH24164	217	—
	180	190	Tr350×5	27	320	22264RK+AH2264	191	HN70
	246	254	Tr350×5	36	320	23264RK+AH3264	280	HN70
	246	254	Tr350×5	36	320	23264RHAK+AH3264	260	HN70
	320	162	171	Tr365×5	28	340	23068RK+AH3068	125
162		171	Tr365×5	28	340	23068RHAK+AH3068	115	HNL73
225		234	Tr370×5	33	340	23168RK+AH3168	239	HN74
225		234	Tr370×5	33	340	23168RHAK+AH3168	225	HN74
269		288	Tr360×5	26	340	24168RRK30+AH24168	293	—

[Note] 1) Basic profile and dimensions of screw thread identified by prefix M are in accordance with JIS B 0205.  
Basic profile and dimensions of screw thread identified by prefix Tr are in accordance with JIS B 0216.



Withdrawal sleeves for spherical roller bearings

$d_1$  320 ~ 380 mm

$d_1$  400 ~ 480 mm

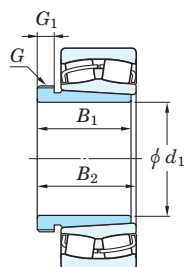

$d_1$	Boundary dimensions (mm)			$G_1$	Brg. bore $d$ (mm)	Designations Bearing + withdrawal sleeve	Mass Brg.+withdrawal sleeve (kg)	(Refer.) Applicable locknut No.
	$B_1$	$B_2$	$G^{1)}$ Screw size					
320	269	288	Tr360×5	26	340	24168RHAK30+AH24168	282	—
	264	273	Tr370×5	38	340	23268RK+AH3268	342	HN74
	264	273	Tr370×5	38	340	23268RHAK+AH3268	317	HN74
340	167	176	Tr385×5	30	360	23072RK+AH3072	132	HNL77
	167	176	Tr385×5	30	360	23072RHAK+AH3072	122	HNL77
	229	238	Tr400×5	35	360	23172RK+AH3172	254	HN80
	232	238	Tr400×5	35	360	23172RHAK+AH3172	239	HN80
	269	289	Tr380×5	26	360	24172RK30+AH24172	313	—
	269	289	Tr380×5	26	360	24172RHAK30+AH24172	300	—
	274	283	Tr400×5	40	360	23272RK+AH3272	388	HN80
	274	283	Tr400×5	40	360	23272RHAK+AH3272	360	HN80
	360	170	180	Tr410×5	31	380	23076RK+AH3076	141
170		180	Tr410×5	31	380	23076RHAK+AH3076	131	HNL82
232		242	Tr420×5	36	380	23176RK+AH3176	269	HN84
240		242	Tr420×5	36	380	23176RHAK+AH3176	253	HN84
271		291	Tr400×5	28	380	24176RK30+AH24176	328	HN80
271		291	Tr400×5	28	380	24176RHAK30+AH24176	314	HN80
284		294	Tr420×5	42	380	23276RK+AH3276	432	HN84
284		294	Tr420×5	42	380	23276RHAK+AH3276	400	HN84
380		183	193	Tr430×5	33	400	23080RK+AH3080	178
	183	193	Tr430×5	33	400	23080RHAK+AH3080	165	HNL86
	240	250	Tr440×5	38	400	23180RK+AH3180	305	HN88
	266	250	Tr440×5	38	400	23180RHAK+AH3180	287	HN88
	278	298	Tr420×5	28	400	24180RK30+AH24180	368	HN84
	278	298	Tr420×5	28	400	24180RHAK30+AH24180	352	HN84
	302	312	Tr440×5	44	400	23280RK+AH3280	521	HN88
	302	312	Tr440×5	44	400	23280RHAK+AH3280	480	HN88

$d_1$	Boundary dimensions (mm)			$G_1$	Brg. bore $d$ (mm)	Designations Bearing + withdrawal sleeve	Mass Brg.+withdrawal sleeve (kg)	(Refer.) Applicable locknut No.
	$B_1$	$B_2$	$G^{1)}$ Screw size					
400	186	196	Tr450×5	34	420	23084RK+AH3084	188	HNL90
	186	196	Tr450×5	34	420	23084RHAK+AH3084	174	HNL90
	266	276	Tr460×5	40	420	23184RK+AH3184	399	HN92
	270	276	Tr460×5	40	420	23184RHAK+AH3184	375	HN92
	321	331	Tr460×5	46	420	23284RK+AH3284	673	HN92
	321	331	Tr460×5	46	420	23284RHAK+AH3284	568	HN92
420	194	205	Tr470×5	35	440	23088RK+AHX3088	215	HNL94
	194	205	Tr470×5	35	440	23088RHAK+AHX3088	199	HNL94
	270	281	Tr480×5	42	440	23188RK+AHX3188	416	HN96
	285	281	Tr480×5	42	440	23188RHAK+AHX3188	391	HN96
	330	341	Tr480×5	48	440	23288RK+AHX3288	678	HN96
	330	341	Tr480×5	48	440	23288RHAK+AHX3288	627	HN96
440	202	213	Tr490×5	37	460	23092RK+AHX3092	244	HNL98
	202	213	Tr490×5	37	460	23092RHAK+AHX3092	226	HNL98
	285	296	Tr510×6	43	460	23192RK+AHX3192	494	HN102
	295	296	Tr510×6	43	460	23192RHAK+AHX3192	464	HN102
	349	360	Tr510×6	50	460	23292RK+AHX3292	795	HN102
	349	360	Tr510×6	50	460	23292RHAK+AHX3292	733	HN102
460	205	217	Tr520×6	38	480	23096RK+AHX3096	257	HNL104
	205	217	Tr520×6	38	480	23096RHAK+AHX3096	238	HNL104
	295	307	Tr530×6	45	480	23196RK+AHX3196	551	HN106
	313	307	Tr530×6	45	480	23196RHAK+AHX3196	518	HN106
	364	376	Tr530×6	52	480	23296RK+AHX3296	914	HN106
	364	376	Tr530×6	52	480	23296RHAK+AHX3296	844	HN106
480	209	221	Tr540×6	40	500	230/500RK+AHX30/500	271	HNL108
	313	325	Tr550×6	47	500	231/500RK+AHX31/500	648	HN110
	393	405	Tr550×6	54	500	232/500RK+AHX32/500	1 015	HN110

[Note] 1) Basic profile and dimensions of screw thread identified by prefix M are in accordance with JIS B 0205.  
Basic profile and dimensions of screw thread identified by prefix Tr are in accordance with JIS B 0216.

## Thrust ball bearings

Thrust ball bearings are divided into single and double direction types. The former is able to accommodate axial load in one direction, while the latter is able to accommodate it in both directions.

Neither is suitable for applications that involve radial load or high-speed rotation.

Bearings whose housing race back face is spherical (with a spherical back face or aligning seat race) are designed with a self-aligning capability and can accommodate the effects of inaccurate mounting.

### Single direction thrust ball bearings

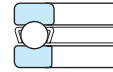

Bore diameter **10 – 360 mm**

### Double direction thrust ball bearings

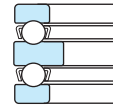

Bore diameter **10 – 190 mm**

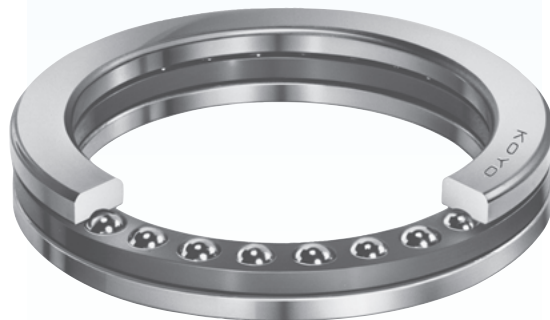

Boundary dimensions	As specified in JIS B 1512.
Tolerances	As specified in JIS B 1514-2. (refer to Table 7-9 on p. A 68.)
Recommended fits	Refer to Table 9-8 on p. A 92.
Standard cages	<ul style="list-style-type: none"> <li>• Pressed steel cage (supplementary code : //)</li> <li>• Copper alloy or carbon steel machined cage (supplementary code : FY or FC)</li> <li>• Polyamide resin molded cage (supplementary code : MG)</li> </ul>

#### Application of standard cages

Bearing series	Molded cage	Pressed cage	Machined cage
511	51100 – 51107	51108 – 51132	51134 – 51172
512	51200 – 51207	51208 – 51224	51226 – 51272
532	53200 – 53207	53208 – 53224	53226 – 53272
532 U	53200U – 53207U	53208U – 53224U	53226U – 53272U
513	–	51305 – 51313	51314 – 51340
533	–	53305 – 53313	53314 – 53340
533 U	–	53305U – 53313U	53314U – 53340U
514	–	51405 – 51416	51417 – 51436
534	–	53405 – 53416	53417 – 53420
534 U	–	53405U – 53416U	53417U – 53420U
522	–	52202 – 52224	52226 – 52244
542	–	54202 – 54224	54226 – 54244
542 U	–	54205U – 54224U	54226U – 54244U
523	–	52305 – 52313	52314 – 52340
543	–	54305 – 54313	54314 – 54324
543 U	–	54305U – 54313U	54314U – 54324U
524	–	52405 – 52411	52412 – 52444
544	–	54405 – 54411	54412 – 54420
544 U	–	54405U – 54411U	54412U – 54420U

Required minimum axial load	A certain degree of load is necessary in order for bearings to operate satisfactorily. (refer to p. A 110.)
Allowable misalignment	Misalignment not allowed. (for flat back face type.)
Equivalent axial load	Dynamic equivalent axial load $P_a = F_a$ Static equivalent axial load $P_{0a} = F_a$

Single direction thrust ball bearings

$d$  10 ~ (40) mm

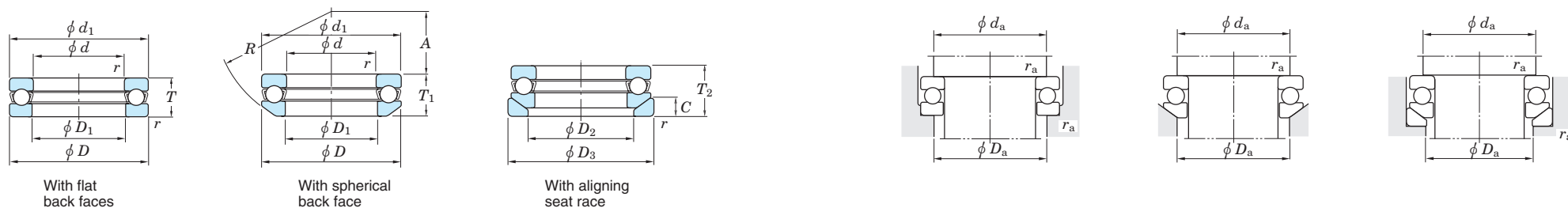

$d$	Boundary dimensions (mm)					Basic load ratings (kN)		Limiting speeds (min <sup>-1</sup> )		Bearing No.			Dimensions (mm)						Mounting dimensions (mm)			(Refer.) Mass (kg)			
	$D$	$T$	$T_1$	$T_2$	$r_{min.}$	$C_a$	$C_{0a}$	Grease lub.	Oil lub.	With flat back faces	With spherical back face	With aligning seat race	$d_1$ max.	$D_1$ min.	$D_2$	$D_3$	$A$	$R$	$C$	$d_a$ min.	$D_a$ max.	$r_a$ max.	With flat back faces	With spherical back face	With aligning seat race
10	24	9	—	—	0.3	10.0	14.0	6 500	10 000	51100	—	—	24	11	—	—	—	—	—	18	16	0.3	0.020	—	—
	26	11	11.6	13	0.6	12.7	17.1	5 700	8 800	51200	53200	53200U	26	12	18	28	8.5	22	3.5	20	16	0.6	0.030	0.029	0.037
12	26	9	—	—	0.3	9.65	14.0	6 500	10 000	51101	—	—	26	13	—	—	—	—	—	20	18	0.3	0.022	—	—
	28	11	11.4	13	0.6	13.2	19.0	5 400	8 300	51201	53201	53201U	28	14	20	30	11.5	25	3.5	22	18	0.6	0.034	0.031	0.043
15	28	9	—	—	0.3	9.95	15.4	6 100	9 400	51102	—	—	28	16	—	—	—	—	—	23	20	0.3	0.024	—	—
	32	12	13.3	15	0.6	16.6	24.8	4 900	7 500	51202	53202	53202U	32	17	24	35	12	28	4	25	22	0.6	0.046	0.048	0.062
17	30	9	—	—	0.3	10.8	18.2	6 100	9 400	51103	—	—	30	18	—	—	—	—	—	25	22	0.3	0.028	—	—
	35	12	13.2	15	0.6	17.2	27.3	4 900	7 500	51203	53203	53203U	35	19	26	38	16	32	4	28	24	0.6	0.053	0.055	0.070
20	35	10	—	—	0.3	14.2	24.7	5 100	7 900	51104	—	—	35	21	—	—	—	—	—	29	26	0.3	0.040	—	—
	40	14	14.7	17	0.6	22.3	37.7	3 900	6 000	51204	53204	53204U	40	22	30	42	18	36	5	32	28	0.6	0.082	0.080	0.100
25	42	11	—	—	0.6	19.5	37.2	4 400	6 800	51105	—	—	42	26	—	—	—	—	—	35	32	0.6	0.059	—	—
	47	15	16.7	19	0.6	27.8	50.4	3 600	5 500	51205	53205	53205U	47	27	36	50	19	40	5.5	38	34	0.6	0.120	0.120	0.152
	52	18	19.8	22	1	35.7	61.4	3 100	4 800	51305	53305	53305U	52	27	38	55	21	45	6	41	36	1	0.180	0.180	0.224
	60	24	26.4	29	1	55.6	89.4	2 600	4 000	51405	53405	53405U	60	27	42	62	19	50	8	46	39	1	0.340	0.350	0.442
30	47	11	—	—	0.6	20.4	42.2	4 300	6 600	51106	—	—	47	32	—	—	—	—	—	40	37	0.6	0.068	—	—
	52	16	17.8	20	0.6	29.4	58.2	3 400	5 200	51206	53206	53206U	52	32	42	55	22	45	5.5	43	39	0.6	0.150	0.160	0.193
	60	21	22.6	25	1	42.8	78.7	2 700	4 200	51306	53306	53306U	60	32	45	62	22	50	7	48	42	1	0.270	0.270	0.326
	70	28	30.1	33	1	72.8	126	2 200	3 400	51406	53406	53406U	70	32	50	75	20	56	9	54	46	1	0.530	0.530	0.660
35	52	12	—	—	0.6	21.2	47.2	3 900	6 000	51107	—	—	52	37	—	—	—	—	—	45	42	0.6	0.090	—	—
	62	18	19.9	22	1	39.2	78.2	2 900	4 500	51207	53207	53207U	62	37	48	65	24	50	7	51	46	1	0.220	0.220	0.277
	68	24	25.6	28	1	55.5	105	2 400	3 700	51307	53307	53307U	68	37	52	72	24	56	7.5	55	48	1	0.390	0.400	0.484
	80	32	34	37	1.1	87.1	155	1 900	2 900	51407	53407	53407U	80	37	58	85	23	64	10	62	53	1	0.790	0.790	0.960
40	60	13	—	—	0.6	26.9	62.8	3 400	5 300	51108	—	—	60	42	—	—	—	—	—	52	48	0.6	0.120	—	—
	68	19	20.3	23	1	47.0	98.3	2 700	4 200	51208	53208	53208U	68	42	55	72	28.5	56	7	57	51	1	0.270	0.270	0.340
	78	26	28.5	31	1	69.3	135	2 100	3 300	51308	53308	53308U	78	42	60	82	28	64	8.5	63	55	1	0.550	0.570	0.690

[Remark] Standard cage types used for the above bearings are described earlier in this section.

Single direction thrust ball bearings

$d$  (40) ~ 70 mm

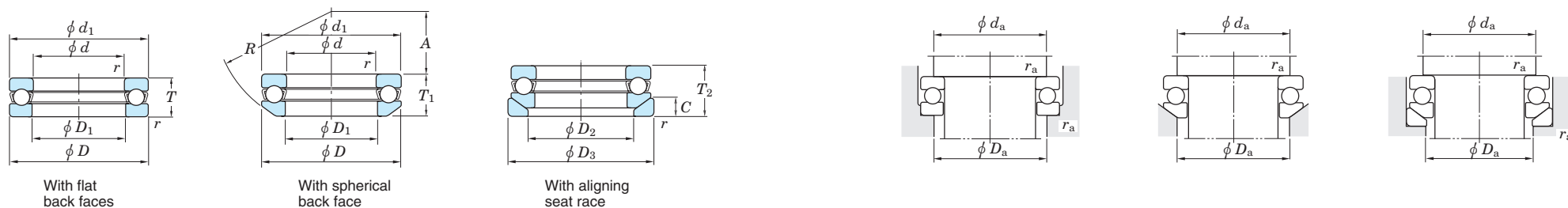

Boundary dimensions (mm)						Basic load ratings (kN)		Limiting speeds (min <sup>-1</sup> )		Bearing No.			Dimensions (mm)						Mounting dimensions (mm)			(Refer.) Mass (kg)				
$d$	$D$	$T$	$T_1$	$T_2$	$r_{min.}$	$C_a$	$C_{0a}$	Grease lub.	Oil lub.	With flat back faces	With spherical back face	With aligning seat race	$d_1$ max.	$D_1$ min.	$D_2$	$D_3$	$A$	$R$	$C$	$d_a$ min.	$D_a$ max.	$r_a$ max.	With flat back faces	With spherical back face	With aligning seat race	
40	90	36	38.2	42	1.1	113	205	1 700	2 600	<b>51408</b>	<b>53408</b>	<b>53408U</b>	90	42	65	95	26	72	12	70	60	1	1.14	1.12	1.37	
	45	65	14	—	—	0.6	27.8	69.1	3 200	5 000	<b>51109</b>	—	—	65	47	—	—	—	—	—	57	53	0.6	0.150	—	—
		73	20	21.3	24	1	47.7	105	2 600	4 000	<b>51209</b>	<b>53209</b>	<b>53209U</b>	73	47	60	78	26	56	7.5	62	56	1	0.320	0.310	0.397
		85	28	30.1	33	1	80.0	163	1 900	3 000	<b>51309</b>	<b>53309</b>	<b>53309U</b>	85	47	65	90	25	64	10	69	61	1	0.690	0.680	0.850
100	39	42.4	46	1.1	130	242	1 500	2 300	<b>51409</b>	<b>53409</b>	<b>53409U</b>	100	47	72	105	29	80	12.5	78	67	1	1.47	1.50	1.82		
50	70	14	—	—	0.6	28.8	75.4	3 100	4 800	<b>51110</b>	—	—	70	52	—	—	—	—	—	62	58	0.6	0.160	—	—	
	78	22	23.5	26	1	48.5	111	2 300	3 600	<b>51210</b>	<b>53210</b>	<b>53210U</b>	78	52	62	82	32.5	64	7.5	67	61	1	0.390	0.380	0.480	
	95	31	34.3	37	1.1	96.6	202	1 800	2 700	<b>51310</b>	<b>53310</b>	<b>53310U</b>	95	52	72	100	28	72	11	77	68	1	1.00	1.01	1.24	
	110	43	45.6	50	1.5	148	283	1 400	2 100	<b>51410</b>	<b>53410</b>	<b>53410U</b>	110	52	80	115	35	90	14	86	74	1.5	1.99	1.97	2.38	
55	78	16	—	—	0.6	34.8	93.1	2 800	4 300	<b>51111</b>	—	—	78	57	—	—	—	—	—	69	64	0.6	0.240	—	—	
	90	25	27.3	30	1	69.4	159	2 100	3 200	<b>51211</b>	<b>53211</b>	<b>53211U</b>	90	57	72	95	35	72	9	76	69	1	0.610	0.620	0.770	
	105	35	39.3	42	1.1	119	246	1 600	2 400	<b>51311</b>	<b>53311</b>	<b>53311U</b>	105	57	80	110	30	80	11.5	85	75	1	1.34	1.41	1.69	
	120	48	50.5	55	1.5	178	359	1 200	1 900	<b>51411</b>	<b>53411</b>	<b>53411U</b>	120	57	88	125	28	90	15.5	94	81	1.5	2.64	2.57	3.10	
60	85	17	—	—	1	41.4	113	2 600	4 000	<b>51112</b>	—	—	85	62	—	—	—	—	—	75	70	1	0.290	—	—	
	95	26	28	31	1	73.6	179	1 900	3 000	<b>51212</b>	<b>53212</b>	<b>53212U</b>	95	62	78	100	32.5	72	9	81	74	1	0.690	0.690	0.850	
	110	35	38.3	42	1.1	124	267	1 500	2 300	<b>51312</b>	<b>53312</b>	<b>53312U</b>	110	62	85	115	41	90	11.5	90	80	1	1.43	1.47	1.78	
	130	51	54	58	1.5	214	437	1 100	1 700	<b>51412</b>	<b>53412</b>	<b>53412U</b>	130	62	95	135	34	100	16	102	88	1.5	3.51	3.44	4.13	
65	90	18	—	—	1	41.7	117	2 400	3 700	<b>51113</b>	—	—	90	67	—	—	—	—	—	80	75	1	0.340	—	—	
	100	27	28.7	32	1	74.9	189	1 900	2 900	<b>51213</b>	<b>53213</b>	<b>53213U</b>	100	67	82	105	40	80	9	86	79	1	0.770	0.750	0.930	
	115	36	39.4	43	1.1	128	287	1 400	2 200	<b>51313</b>	<b>53313</b>	<b>53313U</b>	115	67	90	120	38.5	90	12.5	95	85	1	1.57	1.61	1.95	
	140	56	60.2	65	2	232	493	1 000	1 600	<b>51413</b>	<b>53413</b>	<b>53413U</b>	140	68	100	145	40	112	17.5	110	95	2	4.47	4.47	5.28	
70	95	18	—	—	1	43.1	127	2 300	3 600	<b>51114</b>	—	—	95	72	—	—	—	—	—	85	80	1	0.360	—	—	
	105	27	28.8	32	1	76.1	199	1 800	2 800	<b>51214</b>	<b>53214</b>	<b>53214U</b>	105	72	88	110	38	80	9	91	84	1	0.810	0.800	0.990	
	125	40	44.2	48	1.1	134	291	1 300	2 000	<b>51314</b>	<b>53314</b>	<b>53314U</b>	125	72	98	130	43	100	13	103	92	1	2.06	2.15	2.56	
	150	60	63.6	69	2	250	553	940	1 450	<b>51414</b>	<b>53414</b>	<b>53414U</b>	150	73	110	155	34	112	19.5	118	102	2	5.48	5.38	6.37	

[Remark] Standard cage types used for the above bearings are described earlier in this section.

# Single direction thrust ball bearings

$d$  75 ~ (120) mm

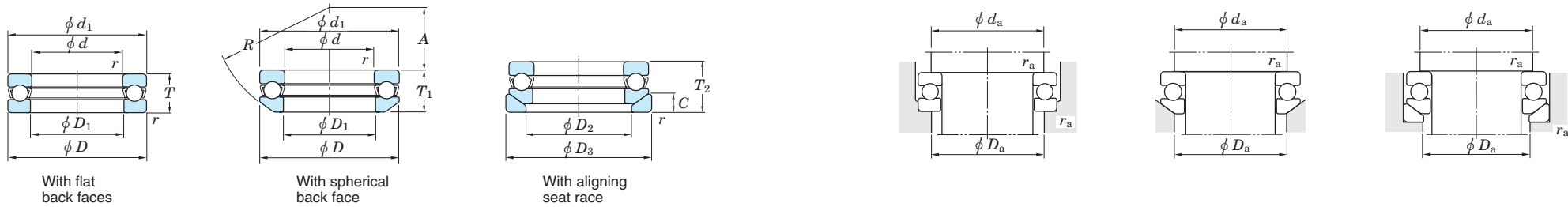

$d$	Boundary dimensions (mm)					Basic load ratings (kN)		Limiting speeds (min <sup>-1</sup> )		Bearing No.			Dimensions (mm)						Mounting dimensions (mm)			(Refer.) Mass (kg)			
	$D$	$T$	$T_1$	$T_2$	$r_{min.}$	$C_a$	$C_{0a}$	Grease lub.	Oil lub.	With flat back faces	With spherical back face	With aligning seat race	$d_1$ max.	$D_1$ min.	$D_2$	$D_3$	$A$	$R$	$C$	$d_a$ min.	$D_a$ max.	$r_a$ max.	With flat back faces	With spherical back face	With aligning seat race
<b>75</b>	100	19	—	—	1	44.4	136	2 200	3 400	<b>51115</b>	—	—	100	77	—	—	—	—	—	90	85	1	0.420	—	—
	110	27	28.3	32	1	77.4	209	1 800	2 700	<b>51215</b>	<b>53215</b>	<b>53215U</b>	110	77	92	115	49	90	9.5	96	89	1	0.860	0.850	1.06
	135	44	48.1	52	1.5	154	339	1 200	1 900	<b>51315</b>	<b>53315</b>	<b>53315U</b>	135	77	105	140	37	100	15	111	99	1.5	2.68	2.72	3.27
	160	65	69	75	2	252	560	880	1 350	<b>51415</b>	<b>53415</b>	<b>53415U</b>	160	78	115	165	42	125	21	125	110	2	6.75	6.64	7.87
<b>80</b>	105	19	—	—	1	44.7	141	2 100	3 300	<b>51116</b>	—	—	105	82	—	—	—	—	—	95	90	1	0.430	—	—
	115	28	29.5	33	1	78.5	218	1 700	2 600	<b>51216</b>	<b>53216</b>	<b>53216U</b>	115	82	98	120	46	90	10	101	94	1	0.950	0.930	1.15
	140	44	47.6	52	1.5	160	368	1 200	1 800	<b>51316</b>	<b>53316</b>	<b>53316U</b>	140	82	110	145	50	112	15	116	104	1.5	2.82	2.86	3.43
	170	68	72.2	78	2.1	270	621	810	1 250	<b>51416</b>	<b>53416</b>	<b>53416U</b>	170	83	125	175	36	125	22	133	117	2	7.97	7.84	9.22
<b>85</b>	110	19	—	—	1	45.9	150	2 100	3 200	<b>51117</b>	—	—	110	87	—	—	—	—	—	100	95	1	0.460	—	—
	125	31	33.1	37	1	95.4	264	1 500	2 300	<b>51217</b>	<b>53217</b>	<b>53217U</b>	125	88	105	130	52	100	11	109	101	1	1.29	1.28	1.57
	150	49	53.1	58	1.5	186	419	1 100	1 700	<b>51317</b>	<b>53317</b>	<b>53317U</b>	150	88	115	155	43	112	17.5	124	111	1.5	3.66	3.63	4.44
	180	72	77	83	2.1	307	753	780	1 200	<b>51417</b>	<b>53417</b>	<b>53417U</b>	177	88	130	185	47	140	23	141	124	2	9.29	9.20	10.8
<b>90</b>	120	22	—	—	1	59.7	190	1 900	2 900	<b>51118</b>	—	—	120	92	—	—	—	—	—	108	102	1	0.680	—	—
	135	35	38.5	42	1.1	117	326	1 400	2 100	<b>51218</b>	<b>53218</b>	<b>53218U</b>	135	93	110	140	45	100	13.5	117	108	1	1.77	1.77	2.19
	155	50	54.6	59	1.5	193	454	1 000	1 600	<b>51318</b>	<b>53318</b>	<b>53318U</b>	155	93	120	160	40	112	18	129	116	1.5	3.88	3.87	4.71
	190	77	81.2	88	2.1	327	826	710	1 100	<b>51418</b>	<b>53418</b>	<b>53418U</b>	187	93	140	195	40	140	25.5	149	131	2	11.0	10.7	12.6
<b>100</b>	135	25	—	—	1	85.0	268	1 600	2 500	<b>51120</b>	—	—	135	102	—	—	—	—	—	121	114	1	0.990	—	—
	150	38	40.9	45	1.1	146	410	1 200	1 900	<b>51220</b>	<b>53220</b>	<b>53220U</b>	150	103	125	155	52	112	14	130	120	1	2.36	2.34	2.84
	170	55	59.2	64	1.5	236	595	940	1 450	<b>51320</b>	<b>53320</b>	<b>53320U</b>	170	103	135	175	46	125	18	142	128	1.5	5.11	5.10	6.05
	210	85	90	98	3	368	983	620	950	<b>51420</b>	<b>53420</b>	<b>53420U</b>	205	103	155	220	50	160	27	165	145	2.5	14.6	14.5	17.4
<b>110</b>	145	25	—	—	1	87.0	288	1 600	2 400	<b>51122</b>	—	—	145	112	—	—	—	—	—	131	124	1	1.08	—	—
	160	38	40.2	45	1.1	152	450	1 200	1 800	<b>51222</b>	<b>53222</b>	<b>53222U</b>	160	113	135	165	65	125	14	140	130	1	2.57	2.50	3.06
	190	63	67.2	72	2	267	704	810	1 250	<b>51322</b>	<b>53322</b>	<b>53322U</b>	187	113	150	195	51	140	20.5	158	142	2	7.72	7.63	8.90
	230	95	—	—	3	379	1 070	550	850	<b>51422</b>	—	—	225	113	—	—	—	—	—	181	159	2.5	19.8	—	—
<b>120</b>	155	25	—	—	1	89.0	305	1 500	2 300	<b>51124</b>	—	—	155	122	—	—	—	—	—	141	134	1	1.16	—	—

[Remark] Standard cage types used for the above bearings are described earlier in this section.

Single direction thrust ball bearings

$d$  (120) ~ (180) mm

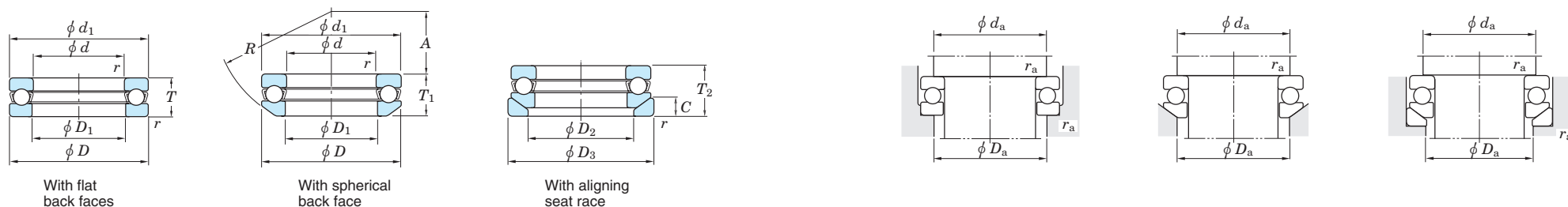

Boundary dimensions (mm)						Basic load ratings (kN)		Limiting speeds (min <sup>-1</sup> )		Bearing No.			Dimensions (mm)						Mounting dimensions (mm)			(Refer.) Mass (kg)			
$d$	$D$	$T$	$T_1$	$T_2$	$r_{min.}$	$C_a$	$C_{0a}$	Grease lub.	Oil lub.	With flat back faces	With spherical back face	With aligning seat race	$d_1$ max.	$D_1$ min.	$D_2$	$D_3$	$A$	$R$	$C$	$d_a$ min.	$D_a$ max.	$r_a$ max.	With flat back faces	With spherical back face	With aligning seat race
<b>120</b>	170	39	40.8	46	1.1	154	470	1 100	1 700	<b>51224</b>	<b>53224</b>	<b>53224U</b>	170	123	145	175	61	125	15	150	140	1	2.86	2.81	3.46
	210	70	74.1	80	2.1	311	869	710	1 100	<b>51324</b>	<b>53324</b>	<b>53324U</b>	205	123	165	220	63	160	22	173	157	2	10.6	10.4	12.4
	250	102	—	—	4	480	1 460	520	800	<b>51424</b>	—	—	245	123	—	—	—	—	—	196	174	3	25.0	—	—
<b>130</b>	170	30	—	—	1	104	350	1 300	2 000	<b>51126</b>	—	—	170	132	—	—	—	—	—	154	146	1	1.87	—	—
	190	45	47.9	53	1.5	203	620	970	1 500	<b>51226</b>	<b>53226</b>	<b>53226U</b>	187	133	160	195	67	140	17	166	154	1.5	4.09	3.98	4.88
	225	75	80.3	86	2.1	330	958	650	1 000	<b>51326</b>	<b>53326</b>	<b>53326U</b>	220	134	177	235	53	160	26	186	169	2	13.0	12.7	15.2
	270	110	—	—	4	498	1 540	490	750	<b>51426</b>	—	—	265	134	—	—	—	—	—	212	188	3	31.4	—	—
<b>140</b>	180	31	—	—	1	107	375	1 200	1 900	<b>51128</b>	—	—	178	142	—	—	—	—	—	164	156	1	2.02	—	—
	200	46	48.6	55	1.5	205	650	940	1 450	<b>51228</b>	<b>53228</b>	<b>53228U</b>	197	143	170	210	87	160	17	176	164	1.5	4.46	4.35	5.89
	240	80	84.9	92	2.1	365	1 130	620	950	<b>51328</b>	<b>53328</b>	<b>53328U</b>	235	144	190	250	68	180	26	199	181	2	15.5	15.1	18.0
	280	112	—	—	4	520	1 680	450	700	<b>51428</b>	—	—	275	144	—	—	—	—	—	222	198	3	33.9	—	—
<b>150</b>	190	31	—	—	1	109	400	1 200	1 900	<b>51130</b>	—	—	188	152	—	—	—	—	—	174	166	1	2.15	—	—
	215	50	53.3	60	1.5	213	652	840	1 300	<b>51230</b>	<b>53230</b>	<b>53230U</b>	212	153	180	225	79	160	20.5	189	176	1.5	5.64	5.45	7.14
	250	80	83.7	92	2.1	361	1 130	580	900	<b>51330</b>	<b>53330</b>	<b>53330U</b>	245	154	200	260	89.5	200	26	209	191	2	16.3	15.7	18.8
	300	120	—	—	4	568	1 910	420	650	<b>51430</b>	—	—	295	154	—	—	—	—	—	238	212	3	41.6	—	—
<b>160</b>	200	31	—	—	1	112	425	1 200	1 800	<b>51132</b>	—	—	198	162	—	—	—	—	—	184	176	1	2.28	—	—
	225	51	54.7	61	1.5	223	718	810	1 250	<b>51232</b>	<b>53232</b>	<b>53232U</b>	222	163	190	235	74	160	21	199	186	1.5	6.53	6.09	7.90
	270	87	91.7	100	3	410	1 340	550	850	<b>51332</b>	<b>53332</b>	<b>53332U</b>	265	164	215	280	77	200	29	225	205	2.5	21.0	21.0	23.4
	320	130	—	—	5	681	2 410	390	600	<b>51432</b>	—	—	315	164	—	—	—	—	—	254	226	4	51.2	—	—
<b>170</b>	215	34	—	—	1.1	134	510	1 100	1 700	<b>51134</b>	—	—	213	172	—	—	—	—	—	197	188	1	3.25	—	—
	240	55	58.7	65	1.5	261	834	750	1 150	<b>51234</b>	<b>53234</b>	<b>53234U</b>	237	173	200	250	91	180	21.5	212	198	1.5	8.12	7.69	9.83
	280	87	91.3	100	3	463	1 570	520	800	<b>51334</b>	<b>53334</b>	<b>53334U</b>	275	174	220	290	105	225	29	235	215	2.5	22.0	22.0	24.5
	340	135	—	—	5	755	2 730	360	550	<b>51434</b>	—	—	335	174	—	—	—	—	—	270	240	4	60.0	—	—
<b>180</b>	225	34	—	—	1.1	135	525	1 000	1 600	<b>51136</b>	—	—	222	183	—	—	—	—	—	207	198	1	3.39	—	—
	250	56	58.2	66	1.5	265	874	710	1 100	<b>51236</b>	<b>53236</b>	<b>53236U</b>	247	183	210	260	112	200	21.5	222	208	1.5	8.68	8.08	10.4
	300	95	99.3	109	3	463	1 580	490	750	<b>51336</b>	<b>53336</b>	<b>53336U</b>	295	184	240	310	91	225	32	251	229	2.5	28.1	26.9	29.9

[Remark] Standard cage types used for the above bearings are described earlier in this section.

Single direction thrust ball bearings

$d$  (180) ~ 360 mm

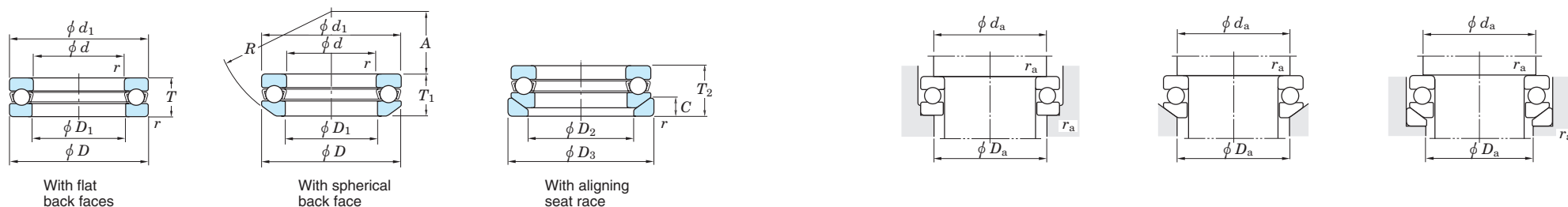

Boundary dimensions (mm)						Basic load ratings (kN)		Limiting speeds (min <sup>-1</sup> )		Bearing No.			Dimensions (mm)						Mounting dimensions (mm)			(Refer.) Mass (kg)			
$d$	$D$	$T$	$T_1$	$T_2$	$r_{min.}$	$C_a$	$C_{0a}$	Grease lub.	Oil lub.	With flat back faces	With spherical back face	With aligning seat race	$d_1$ max.	$D_1$ min.	$D_2$	$D_3$	$A$	$R$	$C$	$d_a$ min.	$D_a$ max.	$r_a$ max.	With flat back faces	With spherical back face	With aligning seat race
<b>180</b>	360	140	—	—	5	742	2 730	320	500	<b>51436</b>	—	—	355	184	—	—	—	—	—	286	254	4	69.5	—	—
<b>190</b>	240	37	—	—	1.1	170	655	970	1 500	<b>51138</b>	—	—	237	193	—	—	—	—	—	220	210	1	3.95	—	—
	270	62	65.7	73	2	308	1 060	650	1 000	<b>51238</b>	<b>53238</b>	<b>53238U</b>	267	194	230	280	98	200	23	238	222	2	11.7	11.2	13.9
	320	105	111	121	4	543	1 950	440	680	<b>51338</b>	<b>53338</b>	<b>53338U</b>	315	195	255	330	104	250	33	266	244	3	36.0	36.3	39.7
<b>200</b>	250	37	—	—	1.1	172	675	940	1 450	<b>51140</b>	—	—	247	203	—	—	—	—	—	230	220	1	4.13	—	—
	280	62	65.3	74	2	314	1 110	620	950	<b>51240</b>	<b>53240</b>	<b>53240U</b>	277	204	240	290	125	225	23	248	232	2	12.2	11.6	14.8
	340	110	118.4	130	4	596	2 220	420	650	<b>51340</b>	<b>53340</b>	<b>53340U</b>	335	205	270	350	92	250	38	282	258	3	42.9	42.7	46.7
<b>220</b>	270	37	—	—	1.1	177	740	880	1 350	<b>51144</b>	—	—	267	223	—	—	—	—	—	250	240	1	4.50	—	—
	300	63	65.6	75	2	342	1 310	580	900	<b>51244</b>	<b>53244</b>	<b>53244U</b>	297	224	260	310	118	225	25	268	252	2	13.5	12.6	15.9
<b>240</b>	300	45	—	—	1.5	241	1 020	750	1 150	<b>51148</b>	—	—	297	243	—	—	—	—	—	276	264	1.5	7.38	—	—
	340	78	81.6	92	2.1	442	1 800	520	800	<b>51248</b>	<b>53248</b>	<b>53248U</b>	335	244	290	350	122	250	30	299	281	2	23.1	20.9	25.6
<b>260</b>	320	45	—	—	1.5	231	990	710	1 100	<b>51152</b>	—	—	317	263	—	—	—	—	—	296	284	1.5	7.93	—	—
	360	79	82.8	93	2.1	445	1 880	490	750	<b>51252</b>	<b>53252</b>	<b>53252U</b>	355	264	305	370	152	280	30	319	301	2	25.0	22.6	28.5
<b>280</b>	350	53	—	—	1.5	329	1 430	640	900	<b>51156</b>	—	—	347	283	—	—	—	—	—	322	308	1.5	12.0	—	—
<b>300</b>	380	62	—	—	2	363	1 610	540	810	<b>51160</b>	—	—	376	304	—	—	—	—	—	348	332	2	17.5	—	—
	420	95	100.5	112	3	570	2 600	400	600	<b>51260</b>	<b>53260</b>	<b>53260U</b>	415	304	360	430	164	320	34	371	349	2.5	42.5	39.5	48.0
<b>320</b>	400	63	—	—	2	379	1 760	540	810	<b>51164</b>	—	—	396	324	—	—	—	—	—	368	352	2	19.0	—	—
	440	95	100.5	112	3	577	2 710	400	600	<b>51264</b>	<b>53264</b>	<b>53264U</b>	435	325	380	450	157	320	36	391	369	2.5	45.0	42.0	52.0
<b>340</b>	420	64	—	—	2	387	1 860	500	770	<b>51168</b>	—	—	416	344	—	—	—	—	—	388	372	2	20.5	—	—
	460	96	100.3	113	3	584	2 830	380	570	<b>51268</b>	<b>53268</b>	<b>53268U</b>	455	345	400	470	199	360	36	411	389	2.5	48.0	45.0	55.0
<b>360</b>	440	65	—	—	2	394	1 960	500	720	<b>51172</b>	—	—	436	364	—	—	—	—	—	408	392	2	21.5	—	—
	500	110	116.7	130	4	701	3 500	340	500	<b>51272</b>	<b>53272</b>	<b>53272U</b>	495	365	430	510	172	360	43	443	417	3	70.0	65.0	82.0

[Remark] Standard cage types used for the above bearings are described earlier in this section.



Double direction thrust ball bearings

$d_2$  10 ~ (50) mm

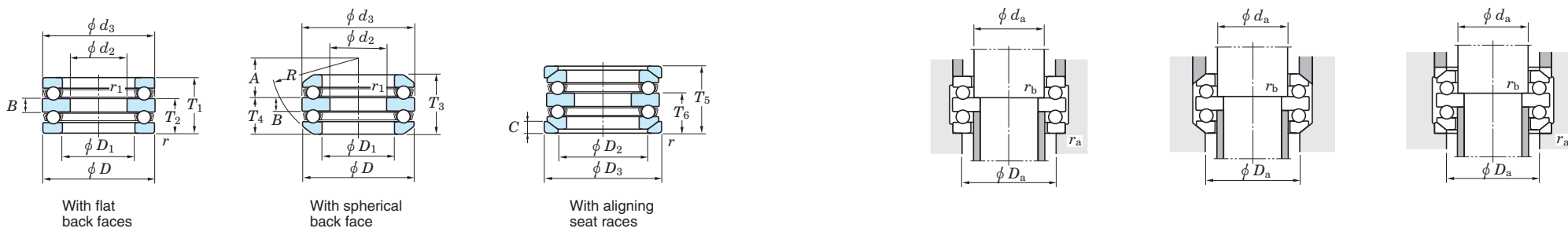

Boundary dimensions (mm)							Basic load ratings (kN)		Limiting speeds (min <sup>-1</sup> )		Bearing No.			Dimensions (mm)									Mounting dimensions (mm)				(Refer.) Mass (kg)			
$d_2$	$D$	$T_1$	$T_3$	$T_5$	$r_{min.}$	$r_{1 min.}$	$C_a$	$C_{0a}$	Grease lub.	Oil lub.	With flat back faces	With spherical back faces	With aligning seat races	$d_{3 max.}$	$D_1 min.$	$D_2$	$D_3$	$T_2$	$T_4$	$T_6$	$A$	$R$	$B$	$C$	$d_a min.$	$D_a max.$	$r_a max.$	$r_b max.$	With flat back faces	With aligning seat races
10	32	22	24.6	28	0.6	0.3	16.6	24.8	4 900	7 500	52202	54202	54202U	32	17	24	35	13.5	14.8	16.5	10.5	28	5	4	15	24	0.6	0.3	0.085	0.118
	40	26	27.4	32	0.6	0.3	22.3	37.7	3 900	6 000	52204	54204	54204U	40	22	30	42	16	16.7	19	16	36	6	5	20	30	0.6	0.3	0.150	0.190
15	60	45	49.8	55	1	0.6	55.6	89.4	2 600	4 000	52405	54405	54405U	60	27	42	62	28	30.4	33	15	50	11	8	25	42	1	0.6	0.630	0.804
	47	28	31.4	36	0.6	0.3	27.7	50.4	3 600	5 500	52205	54205	54205U	47	27	36	50	17.5	19.2	21.5	16.5	40	7	5.5	25	36	0.6	0.3	0.230	0.304
	52	34	37.6	42	1	0.3	35.7	61.4	3 100	4 800	52305	54305	54305U	52	27	38	55	21	22.8	25	18	45	8	6	25	38	1	0.3	0.330	0.428
20	70	52	56.2	62	1	0.6	72.8	126	2 200	3 400	52406	54406	54406U	70	32	50	75	32	34.1	37	16	56	12	9	30	50	1	0.6	1.00	1.25
	52	29	32.6	37	0.6	0.3	28.1	54.3	3 400	5 200	52206	54206	54206U	52	32	42	55	18	19.8	22	20	45	7	5.5	30	42	0.6	0.3	0.270	0.346
	60	38	41.2	46	1	0.3	42.8	78.7	2 700	4 200	52306	54306	54306U	60	32	45	62	23.5	25.1	27.5	19.5	50	9	7	30	45	1	0.3	0.490	0.602
25	80	59	63	69	1.1	0.6	87.1	155	1 900	2 900	52407	54407	54407U	80	37	58	85	36.5	38.5	41.5	18.5	64	14	10	35	58	1	0.6	1.44	1.79
	62	34	37.8	42	1	0.3	40.7	83.8	2 900	4 500	52207	54207	54207U	62	37	48	65	21	22.9	25	21	50	8	7	35	48	1	0.3	0.420	0.544
	68	36	38.6	44	1	0.6	46.9	98.3	2 700	4 200	52208	54208	54208U	68	42	55	72	22.5	23.8	26.5	25	56	9	7	40	55	1	0.6	0.540	0.680
30	68	44	47.2	52	1	0.3	55.5	105	2 400	3 700	52307	54307	54307U	68	37	52	72	27	28.6	31	21	56	10	7.5	35	52	1	0.3	0.710	0.898
	78	49	54	59	1	0.6	69.3	135	2 100	3 300	52308	54308	54308U	78	42	60	82	30.5	33	35.5	23.5	64	12	8.5	40	60	1	0.6	1.06	1.34
	90	65	69.4	77	1.1	0.6	113	205	1 700	2 600	52408	54408	54408U	90	42	65	95	40	42.2	46	22	72	15	12	40	65	1	0.6	2.03	2.55
35	73	37	39.6	45	1	0.6	47.7	105	2 600	4 000	52209	54209	54209U	73	47	60	78	23	24.3	27	23	56	9	7.5	45	60	1	0.6	0.620	0.784
	85	52	56.2	62	1	0.6	80.0	163	1 900	3 000	52309	54309	54309U	85	47	65	90	32	34.1	37	21	64	12	10	45	65	1	0.6	1.29	1.62
	100	72	78.8	86	1.1	0.6	130	242	1 500	2 300	52409	54409	54409U	100	47	72	105	44.5	47.9	51.5	23.5	80	17	12.5	45	72	1	0.6	2.91	3.42
40	78	39	42	47	1	0.6	48.5	111	2 300	3 600	52210	54210	54210U	78	52	62	82	24	25.5	28	30.5	64	9	7.5	50	62	1	0.6	0.710	0.890
	95	58	64.6	70	1.1	0.6	91.6	186	1 800	2 700	52310	54310	54310U	95	52	72	100	36	39.3	42	23	72	14	11	50	72	1	0.6	1.86	2.35
	110	78	83.2	92	1.5	0.6	148	283	1 400	2 100	52410	54410	54410U	110	52	80	115	48	50.6	55	30	90	18	14	50	80	1.5	0.6	3.56	4.39
45	90	45	49.6	55	1	0.6	69.4	159	2 100	3 200	52211	54211	54211U	90	57	72	95	27.5	29.8	32.5	32.5	72	10	9	55	72	1	0.6	1.12	1.44
	105	64	72.6	78	1.1	0.6	119	246	1 600	2 400	52311	54311	54311U	105	57	80	110	39.5	43.8	46.5	25.5	80	15	11.5	55	80	1	0.6	2.51	3.21
	120	87	92	101	1.5	0.6	178	359	1 200	1 900	52411	54411	54411U	120	57	88	125	53.5	56	60.5	22.5	90	20	15.5	55	88	1.5	0.6	4.70	5.62
50	95	46	50	56	1	0.6	73.6	179	1 900	3 000	52212	54212	54212U	95	62	78	100	28	30	33	30.5	72	10	9	60	78	1	0.6	1.25	1.57
	110	64	70.6	78	1.1	0.6	124	267	1 500	2 300	52312	54312	54312U	110	62	85	115	39.5	42.8	46.5	36.5	90	15	11.5	60	85	1	0.6	2.68	3.37
	130	93	99	107	1.5	0.6	201	397	1 100	1 700	52412	54412	54412U	130	62	95	135	57	60	64	28	100	21	16	60	95	1.5	0.6	6.33	7.60

[Remark] Standard cage types used for the above bearings are described earlier in this section.



# Double direction thrust ball bearings

$d_2$  (50) ~ 95 mm

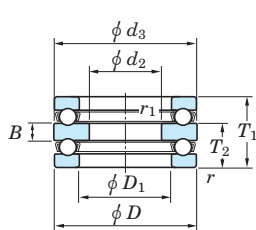

With flat back faces

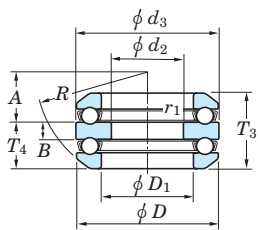

With spherical back face

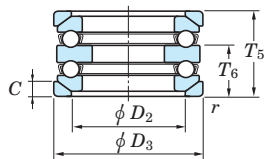

With aligning seat races

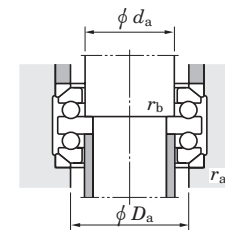
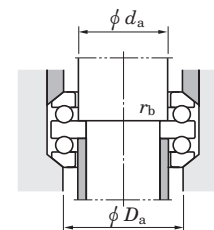
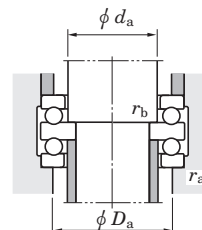

Boundary dimensions (mm)							Basic load ratings (kN)		Limiting speeds (min <sup>-1</sup> )		Bearing No.			Dimensions (mm)										Mounting dimensions (mm)				(Refer.) Mass (kg)		
$d_2$	$D$	$T_1$	$T_3$	$T_5$	$r_{min.}$	$r_{1min.}$	$C_a$	$C_{0a}$	Grease lub.	Oil lub.	With flat back faces	With spherical back faces	With aligning seat races	$d_3$ max.	$D_1$ min.	$D_2$	$D_3$	$T_2$	$T_4$	$T_6$	$A$	$R$	$B$	$C$	$d_a$ min.	$D_a$ max.	$r_a$ max.	$r_b$ max.	With flat back faces	With aligning seat races
<b>50</b>	140	101	109.4	119	2	1	232	493	1 000	1 600	<b>52413</b>	<b>54413</b>	<b>54413U</b>	140	68	100	145	62	66.2	71	34	112	23	17.5	65	100	2	1	8.03	9.72
<b>55</b>	100	47	50.4	57	1	0.6	74.8	189	1 900	2 900	<b>52213</b>	<b>54213</b>	<b>54213U</b>	100	67	82	105	28.5	30.2	33.5	38.5	80	10	9	65	82	1	0.6	1.36	1.70
	105	47	50.6	57	1	1	73.6	189	1 800	2 800	<b>52214</b>	<b>54214</b>	<b>54214U</b>	105	72	88	110	28.5	30.3	33.5	36.5	80	10	9	70	88	1	1	1.48	1.84
	115	65	71.8	79	1.1	0.6	128	287	1 400	2 200	<b>52313</b>	<b>54313</b>	<b>54313U</b>	115	67	90	120	40	43.4	47	34.5	90	15	12.5	65	90	1	0.6	2.90	3.66
	125	72	80.4	88	1.1	1	148	339	1 300	2 000	<b>52314</b>	<b>54314</b>	<b>54314U</b>	125	72	98	130	44	48.2	52	39	100	16	13	70	98	1	1	3.90	4.78
	150	107	114.2	125	2	1	250	553	940	1 450	<b>52414</b>	<b>54414</b>	<b>54414U</b>	150	73	110	155	65.5	69.1	74.5	28.5	112	24	19.5	70	110	2	1	9.71	11.6
<b>60</b>	110	47	49.6	57	1	1	77.4	209	1 800	2 700	<b>52215</b>	<b>54215</b>	<b>54215U</b>	110	77	92	115	28.5	29.8	33.5	47.5	90	10	9.5	75	92	1	1	1.57	1.96
	135	79	87.2	95	1.5	1	171	396	1 200	1 900	<b>52315</b>	<b>54315</b>	<b>54315U</b>	135	77	105	140	48.5	52.6	56.5	32.5	100	18	15	75	105	1.5	1	4.83	6.08
	160	115	123	135	2	1	252	560	880	1 350	<b>52415</b>	<b>54415</b>	<b>54415U</b>	160	78	115	165	70.5	74.5	80.5	36.5	125	26	21	75	115	2	1	11.8	14.3
<b>65</b>	115	48	51	58	1	1	78.5	218	1 700	2 600	<b>52216</b>	<b>54216</b>	<b>54216U</b>	115	82	98	120	29	30.5	34	45	90	10	10	80	98	1	1	1.69	2.09
	140	79	86.2	95	1.5	1	176	424	1 200	1 800	<b>52316</b>	<b>54316</b>	<b>54316U</b>	140	82	110	145	48.5	52.1	56.5	45.5	112	18	15	80	110	1.5	1	5.06	6.36
	170	120	128.4	140	2.1	1	270	621	810	1 250	<b>52416</b>	<b>54416</b>	<b>54416U</b>	170	83	125	175	73.5	77.7	83.5	30.5	125	27	22	80	125	2	1	14.0	16.6
	180	128	138	150	2.1	1.1	307	753	780	1 200	<b>52417</b>	<b>54417</b>	<b>54417U</b>	179.5	88	130	185	78.5	83.5	89.5	40.5	140	29	23	85	130	2	1	17.5	19.7
<b>70</b>	125	55	59.2	67	1	1	92.3	251	1 500	2 300	<b>52217</b>	<b>54217</b>	<b>54217U</b>	125	88	105	130	33.5	35.6	39.5	49.5	100	12	11	85	105	1	1	2.34	2.90
	150	87	95.2	105	1.5	1	206	489	1 100	1 700	<b>52317</b>	<b>54317</b>	<b>54317U</b>	150	88	115	155	53	57.1	62	39	112	19	17.5	85	115	1.5	1	6.43	8.03
	190	135	143.4	157	2.1	1.1	327	826	710	1 100	<b>52418</b>	<b>54418</b>	<b>54418U</b>	189.5	93	140	195	82.5	86.7	93.5	34.5	140	30	25.5	90	140	2	1	19.6	22.8
<b>75</b>	135	62	69	76	1.1	1	117	326	1 400	2 100	<b>52218</b>	<b>54218</b>	<b>54218U</b>	135	93	110	140	38	41.5	45	42	100	14	13.5	90	110	1	1	3.22	4.07
	155	88	97.2	106	1.5	1	213	524	1 000	1 600	<b>52318</b>	<b>54318</b>	<b>54318U</b>	155	93	120	160	53.5	58.1	62.5	36.5	112	19	18	90	120	1.5	1	6.60	8.44
<b>80</b>	210	150	160	176	3	1.1	368	983	620	950	<b>52420</b>	<b>54420</b>	<b>54420U</b>	209.5	103	155	220	91.5	96.5	104.5	43.5	160	33	27	100	155	2.5	1	26.6	32.0
<b>85</b>	150	67	72.8	81	1.1	1	147	410	1 200	1 900	<b>52220</b>	<b>54220</b>	<b>54220U</b>	150	103	125	155	41	43.9	48	49	112	15	14	100	125	1	1	4.29	5.25
	170	97	105.4	115	1.5	1	236	596	940	1 450	<b>52320</b>	<b>54320</b>	<b>54320U</b>	170	103	135	175	59	63.2	68	42	125	21	18	100	135	1.5	1	8.90	10.8
<b>90</b>	230	166	—	—	3	1.1	379	1 070	550	850	<b>52422</b>	—	—	229	113	—	—	101.5	—	—	—	—	37	—	110	170	2.5	1	34.9	—
<b>95</b>	160	67	71.4	81	1.1	1	148	431	1 200	1 800	<b>52222</b>	<b>54222</b>	<b>54222U</b>	160	113	135	165	41	43.2	48	62	125	15	14	110	135	1	1	4.68	5.66
	190	110	118.4	128	2	1	280	754	810	1 250	<b>52322</b>	<b>54322</b>	<b>54322U</b>	189.5	113	150	195	67	71.2	76	47	140	24	20.5	110	150	2	1	13.8	16.3
	250	177	—	—	4	1.5	480	1 460	520	800	<b>52424</b>	—	—	249	123	—	—	108.5	—	—	—	—	40	—	120	185	3	1.5	44.2	—

[Remark] Standard cage types used for the above bearings are described earlier in this section.

# Double direction thrust ball bearings

$d_2$  100 ~ 190 mm

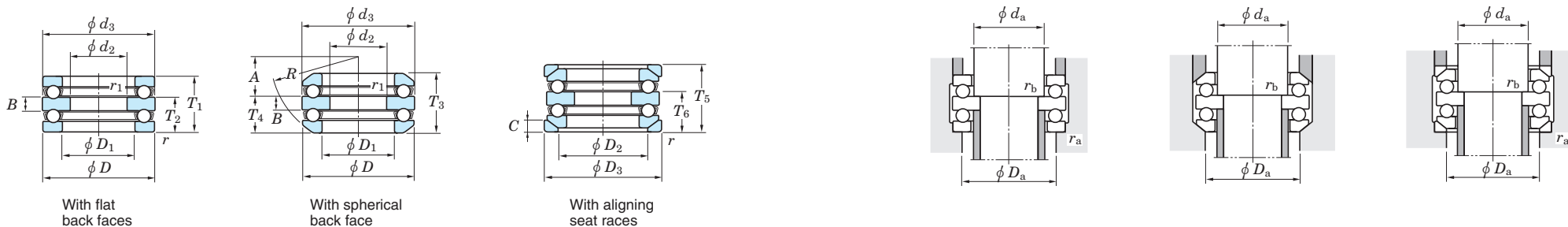

Boundary dimensions (mm)							Basic load ratings (kN)		Limiting speeds (min <sup>-1</sup> )		Bearing No.			Dimensions (mm)										Mounting dimensions (mm)				(Refer.) Mass (kg)		
$d_2$	$D$	$T_1$	$T_3$	$T_5$	$r_{min.}$	$r_{1 min.}$	$C_a$	$C_{0a}$	Grease lub.	Oil lub.	With flat back faces	With spherical back faces	With aligning seat races	$d_3$ max.	$D_1$ min.	$D_2$	$D_3$	$T_2$	$T_4$	$T_6$	$A$	$R$	$B$	$C$	$d_a$ min.	$D_a$ max.	$r_a$ max.	$r_b$ max.	With flat back faces	With aligning seat races
<b>100</b>	170	68	71.6	82	1.1	1.1	154	472	1 100	1 700	<b>52224</b>	<b>54224</b>	<b>54224U</b>	170	123	145	175	41.5	43.3	48.5	58.5	125	15	15	120	145	1	1	5.24	6.44
	210	123	131.2	143	2.1	1.1	325	931	710	1 100	<b>52324</b>	<b>54324</b>	<b>54324U</b>	209.5	123	165	220	75	79.1	85	58	160	27	22	120	165	2	1	17.2	22.9
	270	192	—	—	4	2	498	1 540	490	750	<b>52426</b>	—	—	269	134	—	—	117	—	—	—	—	42	—	130	200	3	2	56.5	—
<b>110</b>	190	80	85.8	96	1.5	1.1	203	622	970	1 500	<b>52226</b>	<b>54226</b>	<b>54226U</b>	189.5	133	160	195	49	51.9	57	63	140	18	17	130	160	1.5	1	7.72	9.29
	225	130	—	—	2.1	1.1	346	1 030	650	1 000	<b>52326</b>	—	—	224	134	—	—	80	—	—	—	—	30	—	130	177	2	1	22.1	—
	280	196	—	—	4	2	520	1 680	450	700	<b>52428</b>	—	—	279	144	—	—	120	—	—	—	—	44	—	140	206	3	2	60.6	—
<b>120</b>	200	81	86.2	99	1.5	1.1	215	669	940	1 450	<b>52228</b>	<b>54228</b>	<b>54228U</b>	199.5	143	170	210	49.5	52.1	58.5	83.5	160	18	17	140	170	1.5	1	8.31	10.5
	240	140	—	—	2.1	1.1	367	1 130	620	950	<b>52328</b>	—	—	239	144	—	—	85.5	—	—	—	—	31	—	140	190	2	1	27.8	—
	300	209	—	—	4	2	568	1 910	420	650	<b>52430</b>	—	—	299	154	—	—	127.5	—	—	—	—	46	—	150	225	3	2	73.9	—
<b>130</b>	215	89	95.6	109	1.5	1.1	244	768	840	1 300	<b>52230</b>	<b>54230</b>	<b>54230U</b>	214.5	153	180	225	54.5	57.8	64.5	74.5	160	20	20.5	150	180	1.5	1	10.6	13.6
	250	140	—	—	2.1	1.1	377	1 200	580	900	<b>52330</b>	—	—	249	154	—	—	85.5	—	—	—	—	31	—	150	200	2	1	29.2	—
	320	226	—	—	5	2	681	2 410	390	600	<b>52432</b>	—	—	319	164	—	—	138	—	—	—	—	50	—	160	240	4	2	90.3	—
<b>135</b>	340	236	—	—	5	2.1	755	2 730	360	550	<b>52434</b>	—	—	339	174	—	—	143	—	—	—	—	50	—	170	255	4	2	108	—
<b>140</b>	225	90	97.4	110	1.5	1.1	247	803	810	1 250	<b>52232</b>	<b>54232</b>	<b>54232U</b>	224.5	163	190	235	55	58.7	65	70	160	20	21	160	190	1.5	1	12.2	14.6
	270	153	—	—	3	1.1	470	1 570	550	850	<b>52332</b>	—	—	269	164	—	—	93	—	—	—	—	33	—	160	215	2.5	1	37.7	—
	360	245	—	—	5	3	742	2 730	320	500	<b>52436</b>	—	—	359	184	—	—	148.5	—	—	—	—	52	—	180	270	4	2.5	126	—
<b>150</b>	240	97	104.4	117	1.5	1.1	269	874	750	1 150	<b>52234</b>	<b>54234</b>	<b>54234U</b>	239.5	173	200	250	59	62.7	69	87	180	21	21.5	170	200	1.5	1	15.2	17.8
	250	98	102.4	118	1.5	2	294	986	710	1 100	<b>52236</b>	<b>54236</b>	<b>54236U</b>	249	183	210	260	59.5	61.7	69.5	108.5	200	21	21.5	180	210	1.5	2	15.9	19.6
	280	153	—	—	3	1.1	463	1 570	520	800	<b>52334</b>	—	—	279	174	—	—	93	—	—	—	—	33	—	170	220	2.5	1	39.6	—
	300	165	—	—	3	2	463	1 580	490	750	<b>52336</b>	—	—	299	184	—	—	101	—	—	—	—	37	—	180	240	2.5	2	50.9	—
<b>160</b>	270	109	116.4	131	2	2	298	1 010	650	1 000	<b>52238</b>	<b>54238</b>	<b>54238U</b>	269	194	220	280	66.5	70.2	77.5	93.5	200	24	23	190	230	2	2	21.6	25.2
	320	183	—	—	4	2	543	1 950	440	680	<b>52338</b>	—	—	319	195	—	—	111.5	—	—	—	—	40	—	190	255	3	2	64.9	—
<b>170</b>	280	109	115.6	133	2	2	314	1 110	620	950	<b>52240</b>	<b>54240</b>	<b>54240U</b>	279	204	240	290	66.5	69.8	78.5	120.5	225	24	23	200	240	2	2	22.7	27.3
	340	192	—	—	4	2	596	2 220	420	650	<b>52340</b>	—	—	339	205	—	—	117	—	—	—	—	42	—	200	270	3	2	77.8	—
<b>190</b>	300	110	115.2	134	2	2	342	1 310	580	900	<b>52244</b>	<b>54244</b>	<b>54244U</b>	299	224	260	310	67	69.6	79	114	225	24	25	220	260	2	2	23.9	29.5

[Remark] Standard cage types used for the above bearings are described earlier in this section.

## Spherical thrust roller bearings

### Spherical thrust roller bearings



Bore diameter **60 – 500 mm**

Spherical thrust roller bearings are designed to carry high axial loads. They can also support radial load if magnitude is no more than 55 % of the axial load being carried.

These bearings are not suitable for high-speed rotation.

Having a spherical housing race raceway surface, these bearings are self-alignings, adjusting to axial inclination.

They are usually used with oil lubrication.



Boundary dimensions	As specified in JIS B 1512.
Tolerances	As specified in JIS B 1514-2, class 0. (refer to table 7-10 on p. A 69.)
Recommended fits	Refer to Table 9-8 on p. A 92.
Required minimum axial load	A certain degree of load is necessary in order for bearings to operate satisfactorily. (refer to p. A 110.)
Standard cage	Copper alloy machined cage (supplementary code : FY)
Allowable aligning angle	0.035 – 0.052 rad (2° – 3°) in general, depending on bearing series.
Equivalent axial load	Dynamic equivalent axial load $P_a = 1.2F_r + F_a$ Static equivalent axial load $P_{0a} \doteq 2.7F_r + F_a$ (Note : $F_r / F_a \leq 0.55$ )

# Spherical thrust roller bearings

$d$  60 ~ 160 mm

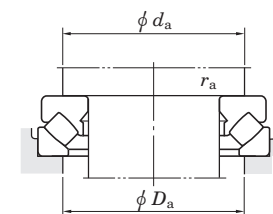
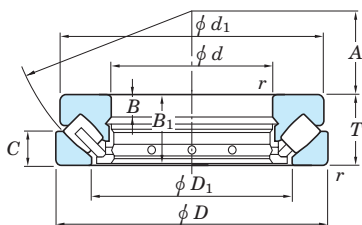

Boundary dimensions (mm)				Basic load ratings (kN)		Limiting speed (min <sup>-1</sup> )	Bearing No.	Dimensions (mm)						Mounting dimensions (mm)			(Refer.) Mass (kg)
$d$	$D$	$T$	$r_{\min.}$	$C_a$	$C_{0a}$	Oil lub.		$d_1$	$D_1$	$B$	$B_1$	$C$	$A$	$d_a$ min.	$D_a$ max.	$r_a$ max.	Mass
<b>60</b>	130	42	1.5	319	884	2 700	<b>29412R</b>	123	89	15	39.5	20	38	90	108	1.5	2.75
<b>65</b>	140	45	2	360	1 020	2 500	<b>29413R</b>	133	96	16	42.5	21	42	100	115	2	3.41
<b>70</b>	150	48	2	387	1 100	2 300	<b>29414R</b>	142	103	17	45.5	23	44	105	125	2	4.16
<b>75</b>	160	51	2	468	1 360	2 100	<b>29415R</b>	152	109	18	48	24	47	115	132	2	4.98
<b>80</b>	170	54	2.1	505	1 480	2 000	<b>29416R</b>	162	117	19	51	26	50	120	140	2	5.95
<b>85</b>	150 180	39 58	1.5 2.1	321 572	1 000 1 700	2 600 1 900	<b>29317R</b> <b>29417R</b>	143.5 170	114 125	13 21	37 55	19 28	50 54	115 130	135 150	1.5 2	2.87 7.19
<b>90</b>	155 190	39 60	1.5 2.1	330 658	1 050 2 010	2 500 1 800	<b>29318R</b> <b>29418R</b>	148.5 180	117 132	13 22	37 57	19 29	52 56	120 135	140 157	1.5 2	3.06 8.28
<b>100</b>	170 210	42 67	1.5 3	385 730	1 270 2 220	2 300 1 650	<b>29320R</b> <b>29420R</b>	163 200	129 146	14 24	40 64	20.8 32	58 62	130 150	150 175	1.5 2.5	3.91 11.2
<b>110</b>	190 230	48 73	2 3	502 896	1 690 2 810	2 000 1 500	<b>29322R</b> <b>29422R</b>	182 220	143 162	16 26	45.5 69	23 35	64 69	145 165	165 190	2 2.5	5.67 14.7
<b>120</b>	210 250	54 78	2.1 4	565 1 040	2 030 3 270	1 800 1 350	<b>29324R</b> <b>29424R</b>	200 236	159 174	18 29	51 74	26 37	70 74	160 180	180 205	2 3	7.90 18.5
<b>130</b>	225 270	58 85	2.1 4	715 1 200	2 440 3 870	1 700 1 250	<b>29326R</b> <b>29426R</b>	215 255	171 189	19 31	55 81	28 41	76 81	170 195	195 225	2 3	9.45 23.5
<b>140</b>	240 280	60 85	2.1 4	707 1 260	2 490 4 080	1 600 1 250	<b>29328</b> <b>29428R</b>	230 268	183 199	20 31	57 81	29 41	82 86	185 205	205 235	2 3	11.1 24.6
<b>150</b>	250 300	60 90	2.1 4	767 1 380	2 740 4 620	1 550 1 100	<b>29330R</b> <b>29430R</b>	240 285	194 214	20 32	57 86	29 44	87 92	195 220	215 250	2 3	11.7 29.6
<b>160</b>	270 320	67 95	3 5	862 1 590	3 070 5 370	1 400 1 050	<b>29332</b> <b>29432R</b>	260 306	208 229	23 34	64 91	32 45	92 99	210 230	235 265	2.5 4	15.4 35.9

# Spherical thrust roller bearings

$d$  170 ~ 320 mm

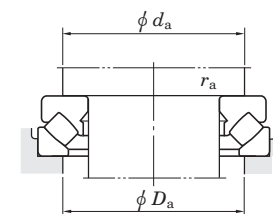
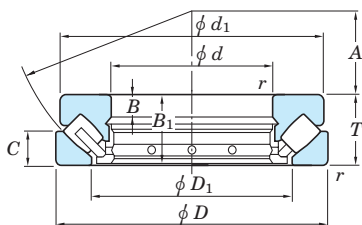

Boundary dimensions (mm)				Basic load ratings (kN)		Limiting speed (min <sup>-1</sup> )	Bearing No.	Dimensions (mm)						Mounting dimensions (mm)			(Refer.) Mass (kg)
$d$	$D$	$T$	$r_{min.}$	$C_a$	$C_{0a}$	Oil lub.		$d_1$	$D_1$	$B$	$B_1$	$C$	$A$	$d_a$ min.	$D_a$ max.	$r_a$ max.	
170	280	67	3	922	3 180	1 350	29334A 29434R	270	216	23	64	32	96	220	245	2.5	15.4
	340	103	5	1 740	5 880	950		324	243	37	99	50	104	245	285	4	44.0
180	300	73	3	896	3 170	1 250	29336 29436R	290	232	25	69	35	103	235	260	2.5	20.7
	360	109	5	1 960	6 590	900		342	255	39	105	52	110	260	300	4	52.2
190	320	78	4	1 170	4 230	1 150	29338 29438R	308	246	27	74	38	110	250	275	3	25.1
	380	115	5	2 230	7 690	850		360	271	41	111	55	117	275	320	4	61.4
200	280	48	2	513	2 170	1 600	29240 29340 29440R	271	236	15	45	24	108	235	255	2	8.90
	340	85	4	1 360	5 040	1 050		325	261	29	81	41	116	265	295	3	31.2
	400	122	5	2 460	8 470	800		380	286	43	117	59	122	290	335	4	73.0
220	300	48	2	536	2 340	1 550	29244 29344 29444R	292	254	15	45	24	117	260	275	2	10.0
	360	85	4	1 380	5 240	1 000		345	280	29	81	41	125	285	315	3	33.3
	420	122	6	2 540	8 990	750		400	308	43	117	58	132	310	355	5	74.2
240	340	60	2.1	822	3 670	1 250	29248 29348A 29448R	330	283	19	57	30	130	285	305	2	16.7
	380	85	4	1 430	5 330	950		365	300	29	81	41	135	300	330	3	35.5
	440	122	6	2 610	9 510	700		420	326	43	117	59	142	330	375	5	83.0
260	360	60	2.1	838	3 720	1 200	29252 29352 29452R	350	302	19	57	30	139	305	325	2	18.5
	420	95	5	1 540	6 040	850		405	329	32	91	45	148	330	365	4	51.5
	480	132	6	3 100	11 100	650		460	357	48	127	64	154	360	405	5	110
280	380	60	2.1	826	3 730	1 150	29256 29356 29456R	370	323	19	57	30	150	325	345	2	19.5
	440	95	5	1 760	6 870	800		423	348	32	91	46	158	350	390	4	53.2
	520	145	6	3 650	13 600	550		495	387	52	140	68	166	390	440	5	137
300	420	73	3	1 060	4 880	950	29260 29360 29460R	405	353	21	69	38	162	355	380	2.5	30.5
	480	109	5	1 970	7 780	700		460	379	37	105	50	168	380	420	4	74.9
	540	145	6	3 880	14 900	550		515	402	52	140	70	175	410	460	5	146
320	440	73	3	1 430	6 480	900	29264R 29364 29464R	430	372	21	69	38	172	375	400	2.5	32.7
	500	109	5	2 310	9 380	650		482	399	37	105	53	180	400	440	4	78.0
	580	155	7.5	4 160	16 100	500		555	435	55	149	75	191	435	495	6	179

$d$  340 ~ 500 mm

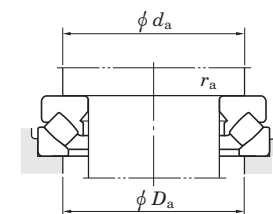
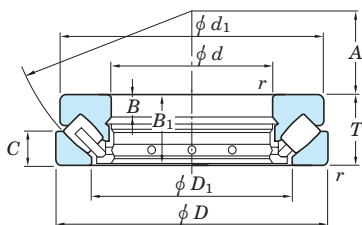

Boundary dimensions (mm)				Basic load ratings (kN)		Limiting speed (min <sup>-1</sup> )	Bearing No.	Dimensions (mm)						Mounting dimensions (mm)			(Refer.) Mass (kg)	
$d$	$D$	$T$	$r_{min.}$	$C_a$	$C_{0a}$	Oil lub.		$d_1$	$D_1$	$B$	$B_1$	$C$	$A$	$d_a$ min.	$D_a$ max.	$r_a$ max.		
<b>340</b>	460	73	3	1 390	6 420	900	<b>29268R</b>	445	395	21	69	37	183	395	420	2.5	34.7	
	540	122	5	3 050	12 700	600		<b>29368R</b>	520	428	41	117	59	192	430	470	4	106
	620	170	7.5	4 960	19 400	450		<b>29468R</b>	590	462	61	164	82	201	465	530	6	224
<b>360</b>	500	85	4	1 310	6 080	750	<b>29272</b>	485	423	25	81	44	194	420	455	3	51.8	
	560	122	5	3 120	13 200	550		<b>29372R</b>	540	448	41	117	59	202	450	495	4	110
	640	170	7.5	5 150	20 600	450		<b>29472R</b>	610	480	61	164	82	210	485	550	6	231
<b>380</b>	520	85	4	1 380	6 610	700	<b>29276</b>	505	441	27	81	42	202	440	475	3	52.8	
	600	132	6	3 540	15 000	500		<b>29376R</b>	580	477	44	127	63	216	480	525	5	141
	670	175	7.5	5 420	22 000	410		<b>29476R</b>	640	504	63	168	85	230	510	575	6	263
<b>400</b>	540	85	4	1 580	7 610	700	<b>29280</b>	526	460	27	81	42	212	460	490	3	55.3	
	620	132	6	3 700	16 100	500		<b>29380R</b>	596	494	44	127	64	225	500	550	5	144
	710	185	7.5	6 200	25 300	380		<b>29480R</b>	680	534	67	178	89	236	540	610	6	315
<b>420</b>	580	95	5	1 850	8 750	600	<b>29284</b>	564	489	30	91	46	225	490	525	4	75.4	
	650	140	6	4 060	17 700	450		<b>29384R</b>	626	520	48	135	68	235	525	575	5	169
	730	185	7.5	6 380	26 500	370		<b>29484R</b>	700	556	67	178	89	244	560	630	6	330
<b>440</b>	600	95	5	1 870	8 970	600	<b>29288</b>	585	508	30	91	49	235	510	545	4	77.9	
	680	145	6	4 290	18 800	420		<b>29388R</b>	655	548	49	140	70	245	550	600	5	190
	780	206	9.5	7 290	30 000	320		<b>29488R</b>	745	588	74	199	100	260	595	670	8	423
<b>460</b>	620	95	5	1 950	9 620	550	<b>29292</b>	605	530	30	91	46	245	530	570	4	81.0	
	710	150	6	3 680	15 800	400		<b>29392</b>	685	567	51	144	72	257	575	630	5	216
	800	206	9.5	7 520	31 600	300		<b>29492R</b>	765	608	74	199	100	272	615	690	8	438
<b>480</b>	650	103	5	2 300	11 600	500	<b>29296</b>	635	556	33	99	55	259	555	595	4	89.0	
	730	150	6	3 650	15 800	390		<b>29396</b>	705	590	51	144	72	270	595	650	5	218
	850	224	9.5	8 690	36 300	270		<b>29496R</b>	810	638	81	216	108	280	645	730	8	548
<b>500</b>	870	224	9.5	8 650	36 400	270	<b>294/500R</b>	830	661	81	216	107	290	670	750	8	562	

## Needle roller bearings

Needle roller bearings are small in sectional height, therefore useful in making machinery smaller and lighter. This type of bearing is used in a wide range of machinery, such as automobiles, motor cycles, electric machines, machine tools, aerospace and office equipment.

- Compact, highly rigid and superior in load carrying performance, compared with other types of bearings.
- Excellent for carrying oscillating loads; contains many small diameter rollers.
- Widely employed in stud type and yoke type track rollers used as guide rollers in cam mechanisms or linear motion units. Allowable loads of these truck rollers are examined with load ratings different from those of general bearings. For detailed information, contact us.  
Also used in miniature one-way clutches in the clutch mechanisms of office equipment, such as copying machines.

For details of needle roller bearings, see the catalog "Needle Roller Bearings", CAT.NO.B2003.

Also see the catalog "Torrington Needle Roller Bearings" CAT.NO.B2016E. This catalog is for the Torrington branded Needle Roller Bearings which JTEKT purchased from The Timken Company.

Torrington® is a registered trademark of The Timken Company.



The catalog also covers bearings employing rollers other than those prescribed in JIS B 1506 "rollers for roller bearings".

### Needle roller and cage assemblies



Bore diameter of a needle roller and cage assembly  
**6 – 95 mm**

### Drawn cup needle roller bearings

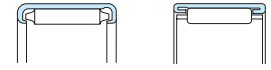

Full complement type      With cage  
Roller set bore diameter  
**4 – 50 mm**

### Machined ring needle roller bearings



Roller set bore diameter  
**12 – 160 mm**

### Needle roller thrust bearings



Bore diameter **10 – 100 mm**

### Stud type track rollers ( cam followers )

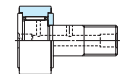

Outside diameter **13 – 90 mm**

### Yoke type track rollers ( roller followers )



Outside diameter **16 – 90 mm**

### Miniature one-way clutches (Refer.)

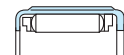

Roller set bore diameter **4 – 12 mm**

**Table 1 Types of needle roller bearing**

	Needle roller and cage assemblies		Drawn cup needle roller bearings		Machined ring needle roller bearings		Needle roller thrust bearings	Stud type track rollers (cam followers)	Yoke type track rollers (roller followers)
	For general use	For use with connecting rods	With cage	Full complement type	Without inner ring	With inner ring			
Basic type		<ul style="list-style-type: none"> <li>For use at large end (for crank pin)</li> <li>BE</li> <li>VE, VS...P</li> <li>For use at small end (for piston pin)</li> <li>RE, R...P, UR...P</li> </ul>	<ul style="list-style-type: none"> <li>Open ends type</li> <li>BTM, BHTM, BT, BHT</li> <li>Closed end type</li> <li>MKM, MHKM, MK, MHK</li> </ul>	<ul style="list-style-type: none"> <li>Open ends type</li> <li>BM, BHM, B, BH</li> <li>YM, Y</li> <li>Closed end type</li> <li>MM, M, MH</li> </ul>	<ul style="list-style-type: none"> <li>Without inner ring</li> <li>RNA49, RNA59</li> <li>NQ, NQS</li> <li>RNA69</li> </ul>	<ul style="list-style-type: none"> <li>With inner ring</li> <li>NA49, NA59</li> <li>NQI, NQIS</li> <li>NA69</li> </ul>	<ul style="list-style-type: none"> <li>Needle roller and cage assembly</li> <li>TV, TP</li> <li>Race*</li> <li>W, WS</li> <li>Combination type (separable type)</li> <li>TPW, TPWS, TPWWS</li> <li>One-piece (non-separable type)</li> <li>TPK..., TVK...</li> </ul>	<ul style="list-style-type: none"> <li>Full complement type</li> <li>CM...M, CR...M</li> <li>CM...RM</li> <li>With cage</li> <li>KM...M</li> <li>KM...RM</li> </ul>	<ul style="list-style-type: none"> <li>Full complement type</li> <li>CYM...M, CYM...RM</li> <li>With cage</li> <li>CXM...M, CXM...RM</li> </ul>
Tolerances	<ul style="list-style-type: none"> <li>The tolerances of needle roller are as specified in JIS B 1506. (refer to Table 2.)</li> <li>Cage width tolerance is given in Table 3.</li> </ul>		<ul style="list-style-type: none"> <li>This type of bearing becomes accurate in terms of performance and dimensions when it is press-fit inside the housing at a specified interference. Therefore, its roller set bore diameter should be measured with the bearing press-fit inside a ring gauge. (refer to Tables 4 and 5.)</li> </ul>		<ul style="list-style-type: none"> <li>As specified in JIS B 1536-1. (refer to Table 6 and 7.)</li> </ul>		<ul style="list-style-type: none"> <li>The dimensional tolerance is given in Table 8 – 11.</li> </ul>	<ul style="list-style-type: none"> <li>As specified in JIS B 1536 for the stud type track roller outer ring outside diameter and width tolerances, as well as the dimensional and running accuracy of yoke type track rollers.</li> <li>The tolerances of stud type track rollers are as shown in Table 12 – 14. The tolerances of yoke type track rollers are as shown in Table 15.</li> </ul>	
Recommended fits and radial internal clearance	Recommended fit is given in Table 16.	To be determined according to engine type and operating conditions.	Recommended fit is given in Table 17.		<ul style="list-style-type: none"> <li>Recommended fit is as shown in Table 18.</li> <li>Radial internal clearance is as shown in Table 10-8 on p. A 100.</li> <li>For bearings which do not have an inner ring, the tolerance class of the roller set and roller complement bore diameters is F 6. Therefore, the radial internal clearance can be determined by choosing the shaft tolerance class. (refer to Table 19.)</li> </ul>		Recommended fit is as shown in Table 20.	Fix the stud type track rollers to the stud tightly so that there will be no play between them. Recommended mounting holes of stud are as shown in Table 21.	Recommended fit is as shown in Table 22.
Shaft and housing specifications	Table 23 gives the requirements for shafts and housings to which needle roller radial bearings are mounted. ( for needle roller and cage assemblies used on connecting rods, refer to JTEKT separate catalog.)				As shown in Table 23.		Table 24 gives the specifications for the fitting face.		

[Remark] \*-marked item indicates the thrust washer or washer specified in JIS.



[Tolerances of needle roller bearings]

Table 2 Tolerance grades of needle rollers (JIS B 1506)

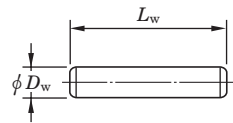

Unit : μm

Class	Single <sup>1)</sup> plane diameter variation $V_{Dwp}$ max.	Deviation <sup>1)</sup> from circular form $\Delta_{Rw}$ max.	Gauge lot <sup>1)</sup> diameter variation $V_{DwL}$ max.
2	1	1	2
3	1.5	1.5	3
5	2	2.5	5

Class	Actual <sup>2)</sup> length deviation $\Delta_{Lws}$	Recommended gauge $S$
2	h 13	0/- 2, - 1/- 3, - 2/- 4, - 3/- 5, - 4/- 6, - 5/- 7, - 6/- 8, - 7/- 9, - 8/- 10
3		0/- 3, - 1.5/- 4.5, - 3/- 6, - 4.5/- 7.5, - 6/- 9, - 7/- 10
5		0/- 5, - 3/- 8, - 5/- 10

[Notes] 1) Values apply only at middle of roller length.  
2) Applied tolerance differs according to  $L_w$  division.

[Remark] Along the entire length of the roller, all the actually measured diameters should not exceed the actual maximum diameter at the middle of the entire length of the roller by the lengths shown below.  
a) Class 2 : 0.5 μm b) Class 3 : 0.8 μm  
c) Class 5 : 1 μm

Table 3 Tolerance of needle roller cage width B

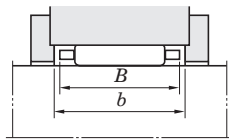

Bearing type	B deviation (mm)	
	upper	lower
R, RS, RP (Welded type), RV, V, VS, WR, WRS, WRP, WV	-0.2	-0.55
VP, VPS	-0.2	-0.7

[Remark] Values in Italics are prescribed in JTEKT standards.

[Reference] The guide width (b) should satisfy the equation :  $b = B + x$  (x : 0.2 to 0 mm)

Table 4 Metric series drawn cup needle roller bearing inspecting gauge specifications

Unit : mm

Nominal bore diameter of rolling element complement $F_w$	Ring gauge	Plug gauge	
		Go end	No-go end
4	7.996	4.023	4.048
5	8.996	5.023	5.048
6	9.996	6.028	6.053
7	10.995	7.031	7.056
8	11.995 14.995	8.031	8.056
9	12.995 15.995	9.031	9.056
10	13.995 16.995	10.031	10.056
12	15.995 17.995 18.993	12.031	12.056
13	18.993	13.034	13.059
14	18.993 19.993 21.993	14.034	14.059
15	19.993 20.993 21.993	15.034	15.059
16	21.993 23.993	16.034	16.059
17	21.972 22.972 23.972	17.013	17.038
18	23.972 24.972	18.013	18.038
19	26.972	19.013	19.038
20	25.972 26.972	20.013	20.038
22	27.972 28.972 29.972	22.013	22.038
24	29.972 30.967 34.967	24.013	24.038
25	31.967 32.967	25.013	25.038
26	33.967	26.013	26.038
28	33.967 34.967 36.967	28.013	28.038
30	36.967 37.967 39.967	30.013	30.038
32	37.967 39.967 41.967	32.013	32.038
35	41.967 44.967	35.013	35.038
36	41.967 43.967 47.967	36.013	36.038
37	42.967 46.967	37.013	37.038
38	47.967	38.013	38.038
40	46.967 49.967	40.013	40.043
45	51.961 54.961	45.013	45.043
50	57.961 61.961	50.013	50.043
55	62.961	55.013	55.051

Table 5 Ring gauge specifications and roller set bore diameter tolerance (for bearings designed according to ISO standards)

Unit : mm

Nominal bore diameter of rolling element complement $F_w$	Nominal outside diameter D	Ring gauge	Nominal bore diameter of rolling element complement $F_w$ tolerance	
			lower	upper
4	8	7.984	4.010	4.028
5	9	8.984	5.010	5.028
6	10	9.984	6.010	6.028
7	11	10.980	7.013	7.031
8	12 14	11.980 13.980	8.013	8.031
9	13 15	12.980 14.980	9.013	9.031
10	14 16	13.980 15.980	10.013	10.031
12	16 18	15.980 17.980	12.016	12.034
14	20 22	19.976 21.976	14.016	14.034
15	21 23	20.976 22.976	15.016	15.034
16	22 24	21.976 23.976	16.016	16.034
17	23 25	22.976 24.976	17.016	17.034
18	24 26	23.976 25.976	18.016	18.034
20	26 28	25.976 27.976	20.020	20.041
22	28 30	27.976 29.976	22.020	22.041
25	32 35	31.972 34.972	25.020	25.041
28	35 38	34.972 37.972	28.020	28.041
30	37 40	36.972 39.972	30.020	30.041
32	39 42	38.972 41.972	32.025	32.050
35	42 45	41.972 44.972	35.025	35.050
38	45 48	44.972 47.972	38.025	38.050
40	47 50	46.972 49.972	40.025	47.050
42	49 52	48.972 51.967	42.025	42.050
45	52 55	51.967 54.967	45.025	45.050
50	58	57.967	32.025	32.050
55	63	62.967	55.030	55.060
60	68	67.967	60.030	60.060
65	73	72.967	65.030	65.060
70	78	77.967	70.030	70.060

[Remark] The supplementary code "J" is added as a suffix to the bearing numbers that are designed according to ISO standards.

Table 6 Machined ring needle roller bearings variation of smallest single bore diameter of rolling element complement  $F_{ws \min}$  <sup>1)</sup> (for interchangeable bearings <sup>2)</sup> and bearings without inner ring)

Unit : μm

Nominal bore diameter of rolling element complement $F_w$ (mm)		$F_{ws \min}$ tolerance (F 6)	
over	up to	upper	lower
6	10	+ 22	+ 13
10	18	+ 27	+ 16
18	30	+ 33	+ 20
30	50	+ 41	+ 25
50	80	+ 49	+ 30
80	120	+ 58	+ 36
120	180	+ 68	+ 43
180	250	+ 79	+ 50

[Notes] 1) The smallest single bore diameter of rolling element complement is the diameter of a cylinder whose radial internal clearance disappears completely, at least in one radial direction.  
2) A group of bearings with inner rings that have the same bearing number. Outer ring, cage and needle roller assemblies and inner rings are interchangeable among them.

**Table 7 Radial bearing tolerances = JIS B 1536 =**

**(1) Inner ring**

Unit :  $\mu\text{m}$

Nominal bore diameter $d$ (mm)		Single plane mean bore diameter deviation $\Delta_{dmp}$								Single plane bore diameter variation $V_{dsp}$				Mean bore diameter variation $V_{dmp}$				Radial runout of assembled bearing inner ring $K_{ia}$				$S_d$		Single inner ring width deviation $\Delta B_s$								Inner ring width variation $V_{Bs}$					
		class 0		class 6		class 5		class 4		class 0		class 6		class 5		class 4		class 0		class 6				class 5		class 4		class 0		class 6		class 5		class 4		class 2	
		over	up to	upper	lower	upper	lower	upper	lower	upper	lower	max.				max.				max.		max.		upper	lower	upper	lower	upper	lower	upper	lower	upper	lower	max.			
<b>2.5</b>	<b>10</b>	0	-8	0	-7	0	-5	0	-4	10	9	5	4	6	5	3	2	10	6	4	2.5	7	3	0	-120	0	-120	0	-40	0	-40	15	15	5	2.5	1.5	
<b>10</b>	<b>18</b>	0	-8	0	-7	0	-5	0	-4	10	9	5	4	6	5	3	2	10	7	4	2.5	7	3	0	-120	0	-120	0	-80	0	-80	20	20	5	2.5	1.5	
<b>18</b>	<b>30</b>	0	-10	0	-8	0	-6	0	-5	13	10	6	5	8	6	3	2.5	13	8	4	3	8	4	0	-120	0	-120	0	-120	0	-120	20	20	5	2.5	1.5	
<b>30</b>	<b>50</b>	0	-12	0	-10	0	-8	0	-6	15	13	8	6	9	8	4	3	15	10	5	4	8	4	0	-120	0	-120	0	-120	0	-120	20	20	5	3	1.5	
<b>50</b>	<b>80</b>	0	-15	0	-12	0	-9	0	-7	19	15	9	7	11	9	5	3.5	19	10	5	4	8	5	0	-150	0	-150	0	-150	0	-150	25	25	6	4	1.5	
<b>80</b>	<b>120</b>	0	-20	0	-15	0	-10	0	-8	25	19	10	8	15	11	5	4	25	13	6	5	9	5	0	-200	0	-200	0	-200	0	-200	25	25	7	4	2.5	
<b>120</b>	<b>150</b>	0	-25	0	-18	0	-13	0	-10	31	23	13	10	19	14	7	5	31	18	8	6	10	6	0	-250	0	-250	0	-250	0	-250	30	30	8	5	2.5	
<b>150</b>	<b>180</b>	0	-25	0	-18	0	-13	0	-10	31	23	13	10	19	14	7	5	31	18	8	6	10	6	0	-250	0	-250	0	-250	0	-250	30	30	8	5	4	
<b>180</b>	<b>250</b>	0	-30	0	-22	0	-15	0	-12	38	28	15	12	23	17	8	6	38	20	10	8	11	7	0	-300	0	-300	0	-300	0	-300	30	30	10	6	5	

[Remark] Values in Italics are prescribed in JTEKT standards.

$S_d$  : Perpendicularity of inner ring face with respect to the bore

**(2) Outer ring**

Unit :  $\mu\text{m}$

Nominal outside diameter $D$ (mm)		Single plane mean outside diameter deviation $\Delta_{Dmp}$								Single plane outside diameter variation $V_{Dsp}$				Mean outside diameter variation $V_{Dmp}$				Radial runout of assembled bearing outer ring $K_{ea}$				$S_D$		$\Delta_{Cs}$		Ring width variation $V_{Cs}$					
		class 0		class 6		class 5		class 4		class 0 <sup>1)</sup>		class 6 <sup>1)</sup>		class 5		class 4		class 0		class 6						class 5		class 4			
		over	up to	upper	lower	upper	lower	upper	lower	upper	lower	max.				max.				max.		upper	lower	max.							
<b>6</b>	<b>18</b>	0	-8	0	-7	0	-5	0	-4	10	9	5	4	6	5	3	2	15	8	5	3	8	4	Shall conform to the tolerance $\Delta_{Bs}$ on $d$ of the same bearing	Shall conform to the tolerance $V_{Bs}$ on $d$ of the same bearing	5	2.5				
<b>18</b>	<b>30</b>	0	-9	0	-8	0	-6	0	-5	12	10	6	5	7	6	3	2.5	15	9	6	4	8	4			5	2.5				
<b>30</b>	<b>50</b>	0	-11	0	-9	0	-7	0	-6	14	11	7	6	8	7	4	3	20	10	7	5	8	4			5	2.5				
<b>50</b>	<b>80</b>	0	-13	0	-11	0	-9	0	-7	16	14	9	7	10	8	5	3.5	25	13	8	5	8	4			6	3				
<b>80</b>	<b>120</b>	0	-15	0	-13	0	-10	0	-8	19	16	10	8	11	10	5	4	35	18	10	6	9	5			8	4				
<b>120</b>	<b>150</b>	0	-18	0	-15	0	-11	0	-9	23	19	11	9	14	11	6	5	40	20	11	7	10	5			8	5				
<b>150</b>	<b>180</b>	0	-25	0	-18	0	-13	0	-10	31	23	13	10	19	14	7	5	45	23	13	8	10	5	8	5						
<b>180</b>	<b>250</b>	0	-30	0	-20	0	-15	0	-11	38	25	15	11	23	15	8	6	50	25	15	10	11	7	10	7						
<b>250</b>	<b>315</b>	0	-35	0	-25	0	-18	0	-13	44	31	18	13	26	19	9	7	60	30	18	11	13	8	11	7						

[Note] 1) Shall be applied when locating snap ring is not fitted.

[Remark] Values in Italics are prescribed in JTEKT standards.

$S_D$  : Perpendicularity of outer ring outside surface with respect to the face

$\Delta_{Cs}$  : Deviation of a single outer ring width

**Table 8 Tolerances for needle roller and cage thrust assemblies (type code : TV, TP) = JIS B 1536 =**

<b>(1) Bore diameter</b> Unit : $\mu\text{m}$					<b>(2) Outside diameter</b> Unit : $\mu\text{m}$				
Cage bore diameter $d_c$ (mm)		Smallest single bore ( $d_{cs \text{ min}}$ ) diameter tolerance <sup>1)</sup>		Single plane bore diameter variation $V_{d_{\text{dsp}}}$	Cage outside diameter $D_c$ (mm)		Largest single outside ( $D_{cs \text{ max}}$ ) diameter tolerance <sup>1)</sup>		Single plane outside diameter variation $V_{D_{\text{dsp}}}$
over	up to	upper	lower		over	up to	upper	lower	
6	10	+115	+25	90	18	30	-110	-320	210
10	18	+142	+32	110	30	40	-120	-370	250
18	30	+170	+40	130	40	50	-130	-380	250
30	50	+210	+50	160	50	65	-140	-440	300
50	80	+250	+60	190	65	80	-150	-450	300
80	120	+292	+72	220	80	100	-170	-520	350
					100	120	-180	-530	350
					120	140	-200	-600	400

[Note] 1) The tolerances indicate the limits of differences between  $d_{cs \text{ min}}$  and  $d_c$ .  
 [Remark] The tolerances of thickness conform to JIS B 1506 in a similar manner to roller diameter ( $D_w$ ) (refer to page B 378).

[Note] 1) The tolerances indicate the limits of differences between  $D_{cs \text{ max}}$  and  $D_c$ .  
 [Remark] The tolerances of thickness conform to JIS B 1506 in a similar manner to roller diameter ( $D_w$ ) (refer to page B 378).

**Table 9 Tolerances for races = JIS B 1536 = (Indicates the thrust washer specified in JIS)**

<b>(1) Bore diameter (type code : W)</b> Unit : $\mu\text{m}$					<b>(2) Outside diameter (type code : W)</b> Unit : $\mu\text{m}$				
Race bore diameter $d$ (mm)		Smallest single bore ( $d_{s \text{ min}}$ ) diameter tolerance <sup>1)</sup>		Single plane bore diameter variation $V_{d_{\text{dsp}}}$	Race outside diameter $D$ (mm)		Largest single outside ( $D_{s \text{ max}}$ ) diameter tolerance <sup>1)</sup>		Single plane outside diameter variation $V_{D_{\text{dsp}}}$
over	up to	upper	lower		over	up to	upper	lower	
6	10	+175	+25	120	18	30	-40	-250	330
10	18	+212	+32	180	30	50	-50	-300	390
18	30	+250	+40	210	50	80	-60	-360	460
30	50	+300	+50	250	80	120	-72	-422	540
50	80	+360	+60	300	120	180	-85	-485	630
80	120	+422	+72	350					

[Note] 1) The tolerances indicate the limits of differences between  $d_{s \text{ min}}$  and  $d$ .  
 [Remark] Tolerances of thickness ( $S$ ) shall be equivalent to tolerance class js12 of JIS B 0401-2.

[Note] 1) The tolerances indicate the limits of differences between  $D_{s \text{ max}}$  and  $D$ .  
 [Remarks] 1. Tolerances of thickness ( $S$ ) shall be equivalent to tolerance class js12 of JIS B 0401-2.  
 2. Values in Italics are prescribed in JTEKT standards.

**Table 10 Tolerances for races (Indicates the washer specified in JIS)**

<b>(1) Bore diameter (type code : WS)</b> Unit : $\mu\text{m}$					<b>(2) Outside diameter (type code : WS)</b> Unit : $\mu\text{m}$				
Race bore diameter $d$ (mm)		Smallest single bore ( $d_{s \text{ min}}$ ) diameter tolerance <sup>1)</sup>		Single plane bore diameter variation $V_{d_{\text{dsp}}}$	Race outside diameter $D$ (mm)		Largest single outside ( $D_{s \text{ max}}$ ) diameter tolerance <sup>1)</sup>		Single plane outside diameter variation $V_{D_{\text{dsp}}}$
over	up to	upper	lower		over	up to	upper	lower	
6	10	+175	+25	120	18	30	-40	-250	330
10	18	+212	+32	180	30	50	-50	-300	390
18	30	+250	+40	210	50	80	-60	-360	460
30	50	+300	+50	250	80	120	-72	-422	540
50	80	+360	+60	300	120	180	-85	-485	630
80	120	+422	+72	350					

[Note] 1) The tolerances indicate the limits of differences between  $d_{s \text{ min}}$  and  $d$ .  
 [Remarks] 1. Tolerances of thickness ( $S$ ) shall be equivalent to tolerance class js12 of JIS B 0401-2.  
 2. Values in Italics are prescribed in JTEKT standards.

[Note] 1) The tolerances indicate the limits of differences between  $D_{s \text{ max}}$  and  $D$ .  
 [Remarks] 1. Tolerances of thickness ( $S$ ) shall be equivalent to tolerance class js12 of JIS B 0401-2.  
 2. Values in Italics are prescribed in JTEKT standards.

**Table 11 Tolerances for non-separable needle roller thrust bearings (type code : TVK, TPK)**

<b>(1) Bore diameter</b> Unit : $\mu\text{m}$					<b>(2) Outside diameter</b> Unit : $\mu\text{m}$				
Race bore diameter $d$ (mm)		Smallest single bore ( $d_{s \text{ min}}$ ) diameter tolerance <sup>1)</sup>		Single plane bore diameter variation $V_{d_{\text{dsp}}}$	Race outside diameter $D$ (mm)		Largest single outside ( $D_{s \text{ max}}$ ) diameter tolerance <sup>1)</sup>		Single plane outside diameter variation $V_{D_{\text{dsp}}}$
over	up to	upper	lower		over	up to	upper	lower	
18	30	+250	+40	210	30	50	-50	-300	250
30	50	+300	+50	250	50	80	-60	-360	300
50	80	+360	+60	300	80	120	-72	-422	350

[Note] 1) The tolerances indicate the limits of differences between  $d_{s \text{ min}}$  and  $d$ .  
 [Remark] Values in Italics are prescribed in JTEKT standards.

[Note] 1) The tolerances indicate the limits of differences between  $D_{s \text{ max}}$  and  $D$ .  
 [Remark] Values in Italics are prescribed in JTEKT standards.

**Table 12 Outer ring tolerance of stud type track rollers (cam followers) = JIS B 1536 =**

<b>(1) Metric series</b> Unit : $\mu\text{m}$								
Nominal outside diameter $D$ (mm)	Single plane mean outside diameter deviation $\Delta_{D_{\text{mp}}}$				Single outer ring width deviation $\Delta_{C_s}$		Radial runout of assembled bearing outer ring $K_{\text{ea}}$	
	Cylindrical outside surface		Crowning outside surface		upper	lower		
over	up to	upper	lower	upper	lower	upper	lower	max.
10	18	0	-8	0	-50	0	-120	15
18	30	0	-9	0	-50	0	-120	15
30	50	0	-11	0	-50	0	-120	20
50	80	0	-13	0	-50	0	-120	25
80	120	0	-15	0	-50	0	-120	35

[Remark] Values in Italics are prescribed in JTEKT standards.

**Table 13 Tolerances of shank diameter**

<b>(1) Metric series</b> Unit : $\mu\text{m}$			
Shank diameter $d_1$ (mm)		Deviation of a single shank diameter $\Delta_{d_{1s}}$	
over	up to	upper	lower
3	6	0	-12
6	10	0	-15
10	18	0	-18
18	30	0	-21

**Table 14 Tolerances of shank length**

<b>(1) Metric series</b> Unit : $\mu\text{m}$		
Shank length $B_2$ (mm)	Deviation of a single shank length $\Delta_{B_{2s}}$	
	upper	lower
Total dimensions	+0.8	-0.8

[Remark] Values in Italics are prescribed in JTEKT standards.

**Table 15 Tolerances of yoke type track rollers (metric series) = JIS B 1536 =**

<b>(1) Inner ring</b> Unit : $\mu\text{m}$						<b>(2) Outer ring</b> Unit : $\mu\text{m}$								
Nominal bore diameter $d$ (mm)	Single plane mean bore diameter deviation $\Delta_{d_{\text{mp}}}$				Single inner ring width deviation $\Delta_{B_s}$		Nominal outside diameter $D$ (mm)	Single plane mean outside diameter deviation $\Delta_{D_{\text{mp}}}$				Single outer ring width deviation $\Delta_{C_s}$	Radial runout of assembled bearing outer ring $K_{\text{ea}}$	
	Cylindrical outside surface		Crowning outside surface		upper	lower		Cylindrical outside surface		Crowning outside surface				
over	up to	upper	lower	upper	lower	over	up to	upper	lower	upper	lower	max.		
2.5	10	0	-8	0	-180	10	18	0	-8	0	-50	0	-120	15
10	18	0	-8	0	-210	18	30	0	-9	0	-50	0	-120	15
18	30	0	-10	0	-210	30	50	0	-11	0	-50	0	-120	20
30	50	0	-12	0	-250	50	80	0	-13	0	-50	0	-120	25
						80	120	0	-15	0	-50	0	-120	35

[Remark] Values in Italics are prescribed in JTEKT standards.

[Remark] Values in Italics are prescribed in JTEKT standards.

[Recommended fit and internal clearance]

**Table 16 Recommended fit for needle roller and cage assemblies**

Conditions	Tolerance class		Housing bore
	Shaft		
	$F_w \leq 50\text{mm}$	$F_w > 50\text{mm}$	
High accuracy, impact load, oscillating motion	js 5	h 5	G 6
General	h 5	g 5	
High temperature, large shaft deflection, large misalignment	f 6		

**Table 17 Recommended fit for drawn cup needle roller bearings**

Distinction	Tolerance class		
	Shaft	Housing bore	
		Steel or cast iron	Light alloy, or steel or cast iron of 6 mm or less in thickness
Inner ring rotation	h 6	N 7	R 7 or S 7
Outer ring rotation	f 6	R 7	

[Remarks] 1. When the shaft makes oscillatory motions, the shaft diameter should be 0.013 mm larger than the recommended tolerance.  
 2. When the bearing is provided with an inner ring, the shaft tolerance class j 6 should be selected.

**Table 19 Relation between tolerance class of a shaft provided with a machined ring needle roller bearing (without inner ring) and radial internal clearance**

Roller set/roller complement bore diameter (mm)	C 2	C N	C 3	C 4
Over 3 up to 180	k 5	h 5	f 6	e 6

**Table 18 Recommended fit for machined ring needle roller bearings**

(1) Recommended fits of inner ring and shaft

Operating condition		Shaft diameter (mm)	Class of shaft tolerance range	Applications (for reference)
Stationary inner ring load	Inner ring needs to move smoothly on shaft.	All shaft diameters	g 6	Stationary shaft wheels, tension pulleys, rope sheaves etc.
	Inner ring does not need to move smoothly on shaft.		h 6	
	High accuracy or noiseless rotation is required.		h 5	
Rotating inner ring load	Light load	40 mm or less	js 6	Electric appliances, machine tools, pumps, blowers, carriers etc.
	Normal load	40 mm or less	k 5	Electric motors, turbines, internal combustion engines, wood-working machines etc.
		over 40 100 mm or less	m 5	
		over 100 mm	m 6	
Heavy load or impact load	140 mm or less	n 6	Railway rolling stock axle journals, traction motors	
	over 140 mm	p 6		

(2) Recommended fits of the outer ring and housing

Operating condition		Class of housing bore tolerance range	Applications (for reference)
Rotating outer ring load	Heavy load with shock	P 7	Fly wheels
	Normal load	N 7	Loose wheels, crank shaft, gears
	Light fluctuating load	M 7	Rope pulley, jockey puller
Extreme impact load	Eccentric pump wheel		
Indeterminate direction load	Normal load	K 7	Compressor
	Light load	J 7	Compressor, crank shaft
Stationary outer ring load	Split housing, normal load	H 7	General use
	High accuracy and rigidity are required	K 6	Machine tool spindle

[Notes] 1) This table is applicable to cast iron or steel housing. For light alloy housings, somewhat more interference fits than shown are recommended.  
 2) Interference fits larger than J 7 should not be used in split housings.

**Table 20 Recommended fit for needle roller thrust bearings**

Distinction	Type code	Guide	Tolerance class	
			Shaft	Housing bore
Needle roller and cage thrust assembly	TV TP	Inside	h 8	–
		Outside	–	H 8
Race <sup>1) 2)</sup>	W WS	Inside	h 8	–
		Outside	–	H 8
Non-separable bearing	TVK (TPK) ...JL TVK (TPK) ...J TVK (TPK) ...L	Inside	h 8	–
		Outside	–	H 8

[Notes] 1) Type code W indicates the thrust washer specified in JIS.  
 2) Type code WS indicates the washer specified in JIS.

[Remark] This tolerance class is applicable when the tolerances of bore and outside diameters of bearings are standard.

**Table 21 Tolerances for stud fitting bore**

Bearing type	Tolerance class
CM, KM	H 7

**Table 22 Recommended fit for yoke type track rollers (roller followers)**

Degree of loading	Shaft tolerance class
Light or medium load	g 6 or h 6
Heavy load	k 6

[Remark] Because yoke type track rollers (roller followers) are generally used with the outer ring rotation, they should be attached to the shaft by transition fitting or clearance fitting. If the application involves heavy loading, the shaft should be hardened and the track roller should be attached by interference fitting.

[Shaft and housing specifications]

Table 23 Specifications of needle roller bearing shafts and housings				
Item	Shaft		Housing bore	
	Raceway surface	Fitting surface	Raceway surface	Fitting surface
Roundness	Best if less than one half or one third of the shaft diameter tolerance		Best if less than one half or one third of the bore diameter tolerance	
Cylindricity	5 μm or less per 25 mm, or one half or less of the shaft diameter tolerance		5 μm or less per 25 mm, or one half or less of the bore diameter tolerance	
Roughness (Ra)	0.4 a or less	0.8 a or less	0.6 a or less	1.6 a or less
Hardness	58 HRC or harder <sup>1)</sup> (60 to 64 HRC are best.)	—	58 HRC or harder <sup>1)</sup> (60 to 64 HRC are best.)	—

[Note] 1) Case hardened steel which is carburized or induction-hardened should not only meet the surface hardness requirement specified above but also have a case depth of 52.3 HRC (550 HV) to a depth in the range  $(0.08 \text{ to } 0.1) \times D_w$  mm. ( $D_w$ : roller diameter)  
In general, 30 thru 45 HRC is best for the center hardness.



Table 24 Needle roller thrust bearing mounting surface specifications	
Squareness	 25 μm or less per 25 mm
	 12.5 μm or less per 25 mm
Roughness (Ra)	0.4 a or less
Hardness	58 HRC or harder (60 thru 64 HRC is best.) (refer to the note for Table 23 above regarding depth.)

Table 25 Track capacity of stud type and yoke type track rollers (cam and roller followers)		
<ul style="list-style-type: none"> <li>Track capacity is the maximum load receivable without deformation or indentation of track surfaces contacted by the outer rings of track rollers to allow the track to be used continuously. The values in the specification table are track capacities obtained using track rollers with cylindrical outside surfaces made of HRC 40 steel.</li> <li>Track capacity of the type track rollers with spherical outside surface is 80% of the values listed in the specification table.</li> <li>To obtain track capacity for hardness out of standard, multiply the track capacities by track capacity coefficient listed in the table at right.</li> </ul>	Hardness (HRC)	Track capacity coefficient
	26	0.48
	32	0.64
	36	0.79
	40	1
	44	1.31
	47	1.59
	50	1.99
	53	2.43
	56	2.90
58	3.23	

Needle roller and cage assemblies

$F_w$  9 ~ (15) mm

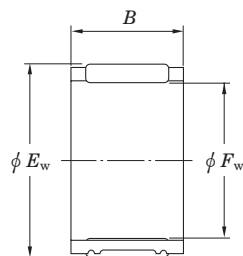

RS, R, RP

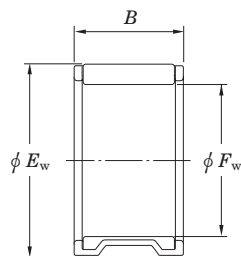

RV, V, VS

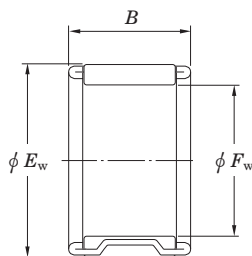

VP, VPS

$F_w$  (15) ~ (20) mm

$\phi E_w$  : Roller set outside diameter

$\phi F_w$  : Roller set bore diameter

Boundary dimensions (mm)			Basic load ratings (kN)		Limiting speeds (min <sup>-1</sup> )	Bearing No.	Special series (Cage)	(Refer.) Mass (g)
$F_w$	$E_w$	$B$	$C_r$	$C_{0r}$	Oil lub.			
9	12	10	3.8	4.0	43 000	RS091210 RF091418	— Polyamide	2.9 5.3
	14	18	9.1	9.0	41 000			
10	13	13	5.8	7.0	41 000	R10/13 RF101320 RS10/8-1	— Polyamide —	4.0 2.4 3.5
	14	8	4.5	4.3	40 000			
	14	10	5.1	5.0	40 000			
	14	13	7.0	7.4	40 000	RS10/10 RS10/13 RP101518	— — Welded	4.3 5.5 7.8
	15	18	10.5	10.9	37 000			
	12	15	13	6.3	8.2	36 000	R12/13 12R1620A RV121712A-2	— — —
16		20	9.5	11.5	35 000			
17		11.5	8.2	8.3	34 000			
13	17	10	5.9	6.4	33 000	RS131710-2 RS131712 13R1815	— — —	5.5 6.5 10
	17	12	7.3	8.4	33 000			
	18	15	10.2	11.2	32 000			
14	18	10	5.8	6.5	31 000	RS141810Q2 RS141815 R14/17A RV141909P1 RS141918	— — — — —	6.0 8.5 10 5.7 13
	18	15	9.6	12.3	31 000			
	18	17	10.1	13.2	31 000			
	19	9	7.0	7.1	30 000			
	19	18	12.3	14.6	30 000			
15	19	7.8	4.7	5.0	29 000	RS151908A R15/10-1 R15/13 R15/17 R15/20 VS15/13 RS15/18A VS15/20	— — — — — — — —	5.0 6.1 7.9 10 12 8.6 14 12
	19	10	6.3	7.2	29 000			
	19	13	8.7	10.9	29 000			
	19	17	10.5	14.0	29 000			
	19	20	12.6	17.7	29 000			
	20	13	10.4	11.9	29 000			
	20	18	13.8	17.2	29 000			
	20	20	16.2	21.2	29 000			

[Note] 1) For further information, consult with JTEKT.

[Remark] Limiting speed of grease lubrication should be kept to under 60 % of that for oil lubrication.

Boundary dimensions (mm)			Basic load ratings (kN)		Limiting speeds (min <sup>-1</sup> )	Bearing No.	Special series (Cage)	(Refer.) Mass (g)
$F_w$	$E_w$	$B$	$C_r$	$C_{0r}$	Oil lub.			
15	21	9	7.4	6.9	28 000	RV152109-4 RS152117	— —	7.8 16
	21	17	13.4	14.8	28 000			
16	20	13	9.4	12.5	28 000	R16/13 16VP2126 16VS2212-2 RS16/24 VPS16/28A	Width tolerance special <sup>1)</sup> Width tolerance special <sup>1)</sup> — Width tolerance special <sup>1)</sup> —	8.5 16 11 23 24
	21	26	19.9	28.0	27 000			
	22	12	9.6	9.6	26 000			
	22	24	20.4	25.6	26 000			
	22	28.4	21.7	27.9	26 000			
17	20	6	3.1	3.6	27 000	RF172006 RF172008A-2 R17/10 R17/13 R17/15 RS172117 17R2220 RS17/13	With single split polyamide With single split polyamide — — — — — —	1.3 1.7 6.8 8.8 10 11 17 14
	20	8	3.8	4.7	27 000			
	21	10	6.8	8.3	26 000			
	21	13	9.4	12.6	26 000			
	21	15	10.7	15.0	26 000			
	21	17	11.3	16.1	26 000			
	22	20	15.2	20.2	26 000			
	23	13	11.4	12.4	25 000			
18	22	13	9.5	13.1	25 000	R18/13 R18/16-8 R18/17 RS182417 RP182517 RF182622A-1 RV182622A-2	— — — Width tolerance special <sup>1)</sup> Welded Polyamide —	9.2 11 12 19 19 19 31
	22	16	11.1	16.0	25 000			
	22	17	11.9	17.4	25 000			
	24	17	15.1	17.9	24 000			
	25	17	17.8	20.1	23 000			
	26	21.9	19.1	20.3	23 000			
	26	21.9	22.7	25.5	23 000			
	19	24	22	16.6	23.3			
20	24	10	7.2	9.4	23 000	R20/10 R20/13P RF202525	— — Polyamide	7.9 10 14
	24	13	9.8	14.0	23 000			
	25	25	18.8	27.9	22 000			



Needle roller and cage assemblies

$F_W$  (20) ~ (22) mm

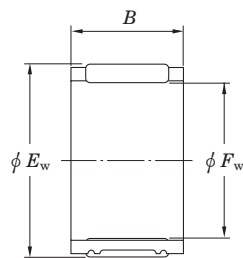

RS, R, RP

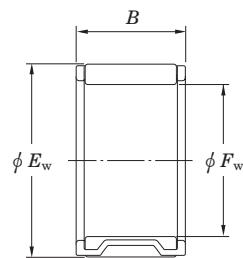

RV, V, VS

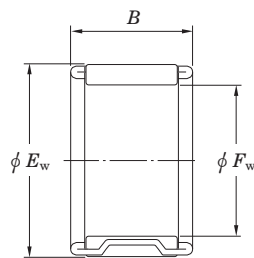

VP, VPS

Boundary dimensions (mm)			Basic load ratings (kN)		Limiting speeds (min <sup>-1</sup> )	Bearing No.	Special series (Cage)	(Refer.) Mass (g)
$F_w$	$E_w$	$B$	$C_r$	$C_{0r}$	Oil lub.			
20	26	11.6	10.7	11.9	22 000	20VS2612	Width tolerance special <sup>1)</sup>	12
	26	12	12.8	15.1	22 000	RV202612-4	—	14
	26	14	14.1	17.0	22 000	VS20/14A	—	15
	26	17	15.8	19.6	22 000	RS20/17	—	21
	26	18.8	17.4	22.3	22 000	RP202619A	—	19
	26	20	18.9	24.7	22 000	VP20/20-1	Width tolerance special <sup>1)</sup>	17
	26	30	26.8	38.9	22 000	RS202630	Welded	39
	27	15	16.2	18.3	21 000	20V2715	—	19
	27	29	25.4	32.6	21 000	20V2729	—	37
	28	20	24.1	28.2	21 000	RP202820	—	28
	28	25	28.8	35.4	21 000	20V2825B	—	37
	30	15	18.2	17.1	20 000	RV203015	—	30
	21	29	22.5	23.7	27.6	20 000	RF212923A	Polyamide
22	26	12	9.6	14.1	21 000	RS222612	—	10
	26	13	10.4	15.6	21 000	R22/13-1	—	11
	26	17	13.0	20.7	21 000	R22/17	—	14
	27	20	17.0	25.2	20 000	RS222720	—	21
	28	11	9.5	10.5	20 000	RS222811	—	15
	28	14	13.2	15.9	20 000	22VS2814E	—	16
	28	17	16.1	20.7	20 000	RS22/17	—	22
	28	22.5	21.3	29.6	20 000	RP222823A	Welded, Width tolerance special <sup>1)</sup>	25
	28	23	24.2	35.1	20 000	VS22/23B	Width tolerance special <sup>1)</sup>	25
	29	17	17.0	20.0	20 000	RV222917	—	23
	30	15	16.7	17.9	19 000	RV223015	—	25
	30	18	21.8	25.2	19 000	RV223018	—	30
	30	20	24.1	28.8	19 000	RV223020-1	—	31
	32	15	21.1	21.3	19 000	RV223215	—	32
	32	16	21.1	21.3	19 000	RV223216	—	35

$F_W$  (22) ~ (25) mm

$\phi E_w$  : Roller set outside diameter

$\phi F_w$  : Roller set bore diameter

Boundary dimensions (mm)			Basic load ratings (kN)		Limiting speeds (min <sup>-1</sup> )	Bearing No.	Special series (Cage)	(Refer.) Mass (g)
$F_w$	$E_w$	$B$	$C_r$	$C_{0r}$	Oil lub.			
22	32	30	40.4	48.9	19 000	RV223230	—	62
23	29	30	26.0	39.0	19 000	23V2930	Width tolerance special <sup>1)</sup>	35
	30	15	17.4	21.0	19 000	RV233015	—	21
	33	20	27.0	29.4	18 000	23V3320-1	Width tolerance special <sup>1)</sup>	44
24	28	13	11.1	17.4	19 000	RS242813	—	12
	28	17	13.7	22.8	19 000	R24/17A	—	16
	28	23	18.2	32.9	19 000	RS242823	—	21
	32	15	20.0	23.2	18 000	RV243215-4	—	27
25	29	9.9	7.1	9.8	19 000	R25/10A	Width tolerance special <sup>1)</sup>	10
	29	13	11.5	18.4	19 000	R25/13-1	—	13
	30	9.9	9.3	12.0	18 000	25R3010A	Width tolerance special <sup>1)</sup>	13
	30	12	10.5	14.1	18 000	25R3012	—	15
	30	17	15.7	23.6	18 000	25V3017	—	18
	30	20	19.0	30.1	18 000	25R3020-1	—	24
	30	20	16.6	25.3	18 000	25VPU3020B	Double split	16
	31	17.5	17.4	23.8	18 000	VPS25/18	—	18
	31	18	17.4	23.8	18 000	RS25/18	—	27
	31	20	21.0	30.5	18 000	VS25/20	Width tolerance special <sup>1)</sup>	26
	31	24	24.9	37.8	18 000	25R3124	—	35
	32	16	18.9	23.8	18 000	25V3216	—	25
	32	24	26.4	36.7	18 000	RS253224	—	43
	32	32	37.8	58.4	18 000	RP253232F-1	Double split	51
	32	32	39.6	62.0	18 000	RV253232	—	49
33	20	24.1	29.8	17 000	RV253320	—	35	
33	23.8	30.2	40.0	17 000	25R3324B-1	Width tolerance special <sup>1)</sup>	48	
33	30	38.6	54.8	17 000	RF253330	Polyamide	41	
35	25	32.5	38.0	17 000	25R3525	—	65	

[Note] 1) For further information, consult with JTEKT.

[Remark] Limiting speed of grease lubrication should be kept to under 60 % of that for oil lubrication.

Needle roller and cage assemblies

$F_w$  (25) ~ 29 mm

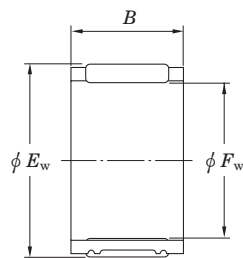

RS, R, RP

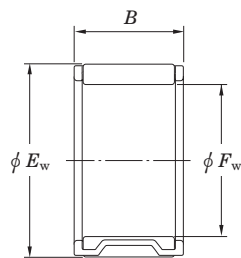

RV, V, VS

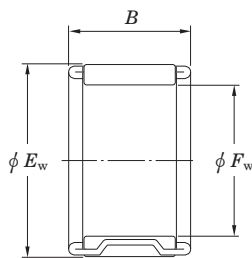

VP, VPS

$F_w$  30 ~ (32) mm

$\phi E_w$  : Roller set outside diameter

$\phi F_w$  : Roller set bore diameter

Boundary dimensions (mm)			Basic load ratings (kN)		Limiting speeds (min <sup>-1</sup> )	Bearing No.	Special series (Cage)	(Refer.) Mass (g)
$F_w$	$E_w$	$B$	$C_r$	$C_{0r}$	Oil lub.			
25	35	30	39.6	49.0	17 000	25V3530A	—	69
	37	24	34.1	36.2	16 000	25V3724	—	69
	37	25	38.3	42.2	16 000	25V3725A	—	77
	37	33	47.5	55.7	16 000	RV253733	—	96
26	30	20	16.9	30.6	18 000	RS263020	—	20
	30	21.9	16.9	30.4	18 000	RS263022A	—	22
	31	16	15.7	23.8	18 000	RS263116	—	20
	31	19	18.5	29.5	18 000	RS263119	—	24
	33	34	30.4	44.0	17 000	RPV263334F	Double split	42
	34	17	23.9	30.0	17 000	RV263417	—	32
27	32	27	26.2	46.6	17 000	RFN27/27	Polyamide, Width tolerance special <sup>1)</sup>	20
	33	28.6	30.0	49.2	17 000	VPSU27/29AF	Double split	33
28	32	26	17.1	31.5	17 000	28R3226	—	27
	32	29	17.1	31.5	17 000	28R3229	—	32
	33	17	17.9	29.0	16 000	28R3317	—	22
	33	23	22.8	39.6	16 000	R28/23A	—	31
	33	27	25.0	44.5	16 000	R28/27	—	36
	36	20	23.2	29.3	16 000	28R3620	—	45
	38	24	31.2	37.1	15 000	RS283824	—	70
	40	28	49.1	59.5	15 000	RV284028	—	90
	41	25	40.2	43.6	14 000	RV284125	—	86
	42	50.5	88.9	116.5	14 000	RF284251A	Polyamide	182
	29	34	22	17.3	27.6	16 000	R29/22A	—
34		24.4	19.7	32.8	16 000	RFU293424A	With double split polyamide	17
34		27	25.7	46.7	16 000	29R3427A-1	—	37
43		43	73.7	92.2	14 000	RV294343	—	177

[Note] 1) For further information, consult with JTEKT.

[Remark] Limiting speed of grease lubrication should be kept to under 60 % of that for oil lubrication.

Boundary dimensions (mm)			Basic load ratings (kN)		Limiting speeds (min <sup>-1</sup> )	Bearing No.	Special series (Cage)	(Refer.) Mass (g)
$F_w$	$E_w$	$B$	$C_r$	$C_{0r}$	Oil lub.			
30	34	14	7.7	11.4	16 000	30R3414A	—	16
	34	14	7.7	11.5	16 000	RFN303414	Polyamide	6.1
	34	29	18.1	34.8	16 000	30R3429	—	34
	34	29	20.4	40.8	16 000	RSU303429	Double split	33
	35	17	17.7	29.2	15 000	R30/17-1	—	24
	35	21.1	22.2	39.0	15 000	RS303521A	—	30
	35	24	24.9	45.1	15 000	RS303524	—	34
	37	16	21.8	30.3	15 000	RV303716	—	29
	37	20	25.2	36.6	15 000	RS30/20A	—	41
	37	26	34.7	55.3	15 000	RV303726	—	47
	38	22.1	27.7	37.5	15 000	RP303822A	Welded	45
	38	28.3	33.5	47.8	15 000	RPV303828AF	Double split	47
	39	27	34.2	45.6	14 000	RP303927	—	51
	39	30	38.3	52.8	14 000	30VP3930A	Width tolerance special <sup>1)</sup>	58
	39	32	42.6	60.5	14 000	RP303932	Welded, Width tolerance special <sup>1)</sup>	63
	40	15.5	26.7	31.1	14 000	RV304016A-4	—	46
	40	20	32.0	39.1	14 000	30V4020	—	55
42	15	27.0	28.0	14 000	RF304215	Polyamide	36	
42	25	44.0	52.3	14 000	RV304225	—	84	
42	32	52.7	66.0	14 000	30V4232	Width tolerance special <sup>1)</sup>	108	
45	30	54.4	60.2	13 000	30V4530	—	135	
31	36	20.3	19.9	34.2	15 000	RFU313620A-1	With double split polyamide	17
32	36	15	10.8	18.3	15 000	32R3615A	—	19
	37	17	19.0	32.6	14 000	R32/17-1	—	26
	37	20	22.3	39.9	14 000	R32/20	—	30
	37	23.8	22.6	40.5	14 000	RF323724A-1	With single split polyamide	20
	37	26	26.2	49.0	14 000	RF323726	Polyamide, Width tolerance special <sup>1)</sup>	24
	37	29.5	31.1	61.2	14 000	VP32/30A	—	32



Needle roller and cage assemblies

$F_w$  (32) ~ (35) mm

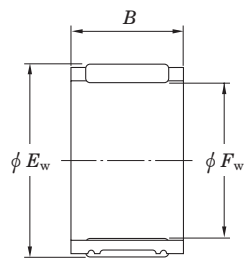

RS, R, RP

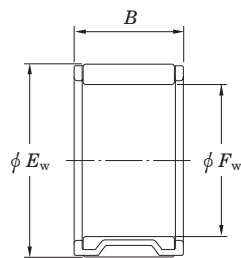

RV, V, VS

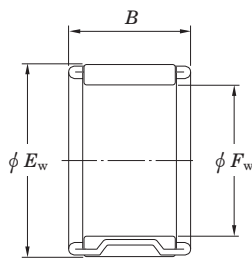

VP, VPS

$F_w$  (35) ~ 37 mm

$\phi E_w$  : Roller set outside diameter

$\phi F_w$  : Roller set bore diameter

Boundary dimensions (mm)			Basic load ratings (kN)		Limiting speeds (min <sup>-1</sup> )	Bearing No.	Special series (Cage)	(Refer.) Mass (g)
$F_w$	$E_w$	$B$	$C_r$	$C_{0r}$	Oil lub.			
32	38	20	24.9	40.6	14 000	32VP3820A	Welded	27
	38	26	27.3	45.6	14 000	RP323826	Width tolerance special <sup>1)</sup>	34
	38	27	29.6	50.7	14 000	32VP3827	Width tolerance special <sup>1)</sup>	38
	39	16	21.2	29.8	14 000	RS323916	—	35
	42	16	27.5	32.9	14 000	RV324216	—	49
	42	20.5	33.5	42.2	14 000	RV324221-1	—	64
	45	28	47.9	56.5	13 000	32V4528	—	112
	46	18	37.0	38.8	13 000	RF324618	Polyamide	57
	46	18	30.3	29.8	13 000	RV324618-1	—	71
	33	37	22	18.5	37.2	14 000	RSU333722F	Double split
34	39	20.3	19.6	34.4	14 000	RFU343920A	With double split polyamide	18
	42	38	49.2	81.9	13 000	34R4238	Width tolerance special <sup>1)</sup>	98
	44	40	64.1	99.1	13 000	34VP4440-1	—	101
35	39	25	22.0	47.4	14 000	RF353925	With single split polyamide	24
	40	13	14.2	23.0	13 000	RS354013	—	22
	40	17	18.4	32.0	13 000	RS354017	—	29
	40	22	23.6	44.4	13 000	RS354022	—	37
	40	24	25.9	49.9	13 000	RS354024	—	39
	40	24.8	23.7	44.4	13 000	RSU354025AF	Double split	39
	40	25	27.0	52.7	13 000	RS354025-1	—	41
	40	26	28.7	56.9	13 000	RS354026	—	41
	40	28	28.7	56.9	13 000	RF354028	Polyamide	27
	40	29	30.6	61.7	13 000	RP354029-1	Width tolerance special <sup>1)</sup>	33
	40	30	30.6	61.7	13 000	VP35/30	—	34
	40	31	30.6	61.6	13 000	RP354031	Welded, Width tolerance special <sup>1)</sup>	37
	40	33	31.1	63.2	13 000	RP354033-1	—	39
	40	35	31.8	64.9	13 000	RF354035	Polyamide	32

[Note] 1) For further information, consult with JTEKT.

[Remark] Limiting speed of grease lubrication should be kept to under 60 % of that for oil lubrication.

Boundary dimensions (mm)			Basic load ratings (kN)		Limiting speeds (min <sup>-1</sup> )	Bearing No.	Special series (Cage)	(Refer.) Mass (g)
$F_w$	$E_w$	$B$	$C_r$	$C_{0r}$	Oil lub.			
35	41	35	40.4	78.0	13 000	35VP4135A	—	51
	41	40	42.4	82.6	13 000	35VP4140A	—	59
	42	20	27.2	42.0	13 000	VS35/20	—	42
	42	30	39.9	68.8	13 000	VS35/30	Width tolerance special <sup>1)</sup>	59
	48	17.5	37.8	42.7	12 000	RV354818A-4	—	81
	49	25	53.4	63.4	12 000	RV354925-1	—	120
	36	40	10	9.6	16.5	13 000	36R4010	—
41	20	21.7	40.3	13 000	RS364120	—	34	
41	25	29.9	60.6	13 000	36RFN4125A	Polyamide	27	
41	30.5	33.1	69.2	13 000	R36/31	—	51	
42	17	20.5	32.8	13 000	RS364217-K	—	35	
42	19	23.2	38.6	13 000	RS364219-K	—	39	
42	21	25.9	44.4	13 000	RS364221-K	—	44	
42	25	33.1	60.9	13 000	RF364225-1	Polyamide	34	
48	25	54.0	71.7	12 000	RF364825-1	Polyamide	80	
52	30	73.9	89.9	11 000	RF365230	Polyamide	139	
37	42	11.6	11.3	17.5	13 000	RS374212A	—	23
	42	12.8	14.0	23.2	13 000	VP37/13A	Width tolerance special <sup>1)</sup>	14
	42	17.3	21.3	39.7	13 000	VP37/17	Width tolerance special <sup>1)</sup>	21
	42	22	24.0	46.3	13 000	37R4222	—	38
	42	23	23.8	45.5	13 000	RF374223-1	With single split polyamide	22
	42	27	30.8	63.6	13 000	RS374227	—	46
	42	27	30.0	61.5	13 000	RSU374227	Double split	45
	42	29	31.9	66.5	13 000	VP37/29	—	35
	42	31	33.9	72.1	13 000	RS374231	Welded	52
	42	32	31.2	64.3	13 000	VP37/32	—	37
	43	32	39.1	75.8	13 000	37R4332	—	66
	43	36.8	40.0	77.9	13 000	RPU374337F	Double split	60

Needle roller and cage assemblies

$F_w$  38 ~ 41 mm

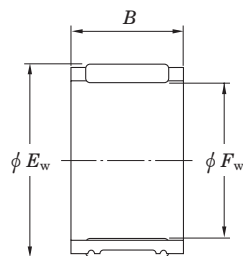

RS, R, RP

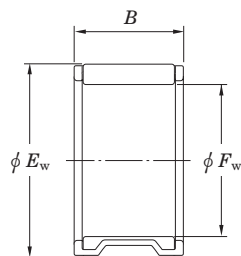

RV, V, VS

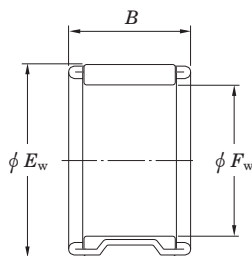

VP, VPS

$F_w$  42 ~ (45) mm

$\phi E_w$  : Roller set outside diameter

$\phi F_w$  : Roller set bore diameter

Boundary dimensions (mm)			Basic load ratings (kN)		Limiting speeds (min <sup>-1</sup> )	Bearing No.	Special series (Cage)	(Refer.) Mass (g)
$F_w$	$E_w$	$B$	$C_r$	$C_{0r}$	Oil lub.			
<b>38</b>	42	10	8.9	15.2	13 000	<b>RF384210</b>	Polyamide	6.6
	44	23.4	25.1	43.1	12 000	<b>RF384423A</b>	Polyamide	26
	44	24.5	27.5	48.4	12 000	<b>RSU384425AF</b>	Double split	51
	44	26	28.7	51.1	12 000	<b>RF384426</b>	Polyamide	29
	44	33	37.9	73.4	12 000	<b>RP384433</b>	—	64
	44	36.2	39.9	78.1	12 000	<b>RP384436A</b>	—	57
	44	39.8	43.7	88.1	12 000	<b>RP384440A</b>	—	65
	52	39	74.8	99.2	11 000	<b>RP385239</b>	—	155
<b>39</b>	46	32.8	42.4	76.9	12 000	<b>39R4633</b>	—	82
	55	20.5	55.0	62.6	11 000	<b>RF395521A</b>	Polyamide	98
	59	23	63.8	66.3	10 000	<b>RV395923-1</b>	—	196
<b>40</b>	45	13	17.1	30.8	12 000	<b>RV404513</b>	—	22
	45	17	19.9	37.4	12 000	<b>R40/17-1</b>	—	32
	45	21.2	23.6	46.6	12 000	<b>RS404521A</b>	—	40
	45	27	29.9	63.0	12 000	<b>RS404527</b>	—	49
	45	30	30.5	64.4	12 000	<b>R40/30</b>	—	55
	45	32	14.3	23.3	12 000	<b>R40/32A</b>	—	53
	46	14.5	21.2	35.5	12 000	<b>RP404615A</b>	Welded	31
	46	29	36.4	70.6	12 000	<b>RS404629</b>	—	65
	47	20	27.6	44.8	11 000	<b>RS40/20</b>	—	54
	47	28.5	38.0	67.6	11 000	<b>RS40/29A</b>	—	77
	48	34	50.4	88.3	11 000	<b>40V4834</b>	—	87
	55	27.5	68.0	85.6	11 000	<b>RF405528A-1</b>	Polyamide	124
	56	20	50.8	56.7	10 000	<b>RV405620-4</b>	—	122
	57	31.5	83.4	103	10 000	<b>RF405732A</b>	Polyamide	168
	60	31.5	94.1	110	10 000	<b>RF406032A</b>	Polyamide	214
	<b>41</b>	46	24	11.0	16.8	11 000	<b>41R4624A</b>	—

[Note] 1) For further information, consult with JTEKT.

[Remark] Limiting speed of grease lubrication should be kept to under 60 % of that for oil lubrication.

Boundary dimensions (mm)			Basic load ratings (kN)		Limiting speeds (min <sup>-1</sup> )	Bearing No.	Special series (Cage)	(Refer.) Mass (g)
$F_w$	$E_w$	$B$	$C_r$	$C_{0r}$	Oil lub.			
<b>42</b>	47	10	13.9	23.8	11 000	<b>RS424710-1</b>	Welded	21
	47	25	29.5	63.1	11 000	<b>RS424725</b>	—	52
	47	27	32.3	70.8	11 000	<b>RS424727</b>	—	51
	47	30	31.9	69.8	11 000	<b>RSU424730</b>	Double split	58
	47	30	36.3	82.4	11 000	<b>VP42/30</b>	—	44
	49	22	29.3	49.0	11 000	<b>RF424922</b>	Polyamide	35
<b>43</b>	48	18	21.9	43.2	11 000	<b>RS434818</b>	—	36
	48	18.5	22.1	43.7	11 000	<b>RS434819A-2</b>	—	38
	48	21.2	25.0	51.5	11 000	<b>RS434821A</b>	—	46
	48	23.3	29.4	63.2	11 000	<b>RS434823A</b>	—	46
	48	24.4	28.2	59.9	11 000	<b>RS434824A</b>	—	49
	48	30	34.1	76.5	11 000	<b>RS434830</b>	Welded	58
<b>43</b>	49	31	40.1	82.5	11 000	<b>43VP4931E</b>	—	55
	52	39.9	65.2	116	11 000	<b>43VP5240</b>	—	114
	<b>44</b>	50	27.5	36.0	72.2	11 000	<b>44RFN5028</b>	Polyamide
50		39	46.4	100	11 000	<b>RP445039</b>	—	71
<b>45</b>	50	13	16.0	29.4	11 000	<b>R45/13</b>	—	28
	50	17	22.7	46.1	11 000	<b>RS455017</b>	—	35
	50	19	24.1	49.7	11 000	<b>R45/19</b>	—	39
	50	20.2	24.1	49.6	11 000	<b>RS455020A</b>	—	46
	50	24	29.3	63.9	11 000	<b>RS455024</b>	—	50
	50	26	31.8	70.9	11 000	<b>R45/26</b>	—	54
	50	33	37.3	87.0	11 000	<b>RS455033-1</b>	—	69
	51	28.6	34.1	67.7	10 000	<b>45RFN5129</b>	Polyamide	40
	51	28.9	37.5	76.9	10 000	<b>RP455129A</b>	Welded	65
	51	28.9	37.5	76.9	10 000	<b>RPU455129AF</b>	Double split	67
	52	22	35.4	63.9	10 000	<b>RS455222</b>	—	66

Needle roller and cage assemblies

$F_w$  (45) ~ (50) mm

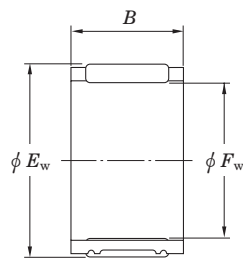

RS, R, RP

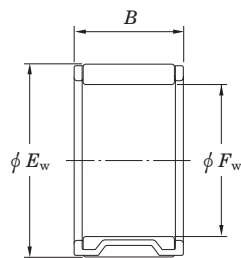

RV, V, VS

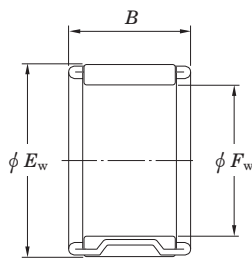

VP, VPS

Boundary dimensions (mm)			Basic load ratings (kN)		Limiting speeds (min <sup>-1</sup> )	Bearing No.	Special series (Cage)	(Refer.) Mass (g)
$F_w$	$E_w$	$B$	$C_r$	$C_{0r}$	Oil lub.			
<b>45</b>	53	25	41.4	71.1	10 000	<b>RV455325P</b>	—	73
	53	26	41.4	71.1	10 000	<b>45V5326P</b>	—	77
	53	28	42.3	73.2	10 000	<b>45VP5328</b>	Width tolerance special <sup>1)</sup>	66
	64	23	64.0	70.4	9 200	<b>RV456423-7</b>	—	191
<b>46</b>	52	20	25.9	48.2	10 000	<b>46VP5220</b>	—	34
	52	37	45.8	100	10 000	<b>46VP5237B</b>	—	67
<b>47</b>	52	30	36.4	85.4	10 000	<b>R47/30H</b>	—	62
	52	30	35.1	81.7	10 000	<b>RSU475230F-1</b>	Double split	62
	53	28.8	35.3	72.3	10 000	<b>RP475329A</b>	—	55
	53	30	42.6	92.1	10 000	<b>RP475330-1</b>	Welded	74
	53	36	47.0	104	10 000	<b>RP475336</b>	—	68
<b>48</b>	53	13	16.1	30.1	9 900	<b>RS485313</b>	—	30
	53	28	34.1	79.2	9 900	<b>48R5328</b>	—	60
	54	20	29.3	57.3	9 800	<b>48R5420-1</b>	—	54
	54	27	38.1	80.4	9 800	<b>48R5427</b>	—	72
	54	28	37.8	79.3	9 800	<b>RS485428</b>	Welded	72
	54	29	39.5	84.3	9 800	<b>48R5429</b>	—	78
	54	30.2	43.8	96.2	9 800	<b>RP485430A-1</b>	Welded	72
	54	39	47.9	108	9 800	<b>48R5439</b>	—	106
	55	21	32.4	58.1	9 700	<b>RP485521</b>	Welded	60
	<b>49</b>	56	44.6	61.2	133	9 500	<b>RP495645A</b>	Welded
56		44.6	61.2	133	9 500	<b>RS495645A</b>	—	146
<b>50</b>	55	17.5	22.3	46.5	9 500	<b>RS505518A</b>	Welded	39
	55	20	25.1	54.3	9 500	<b>RS505520-1</b>	—	47
	55	27	11.5	18.9	9 500	<b>R50/27A</b>	—	56
	56	13	16.7	28.2	9 400	<b>RF505613</b>	Polyamide	18

[Note] 1) For further information, consult with JTEKT.

[Remark] Limiting speed of grease lubrication should be kept to under 60 % of that for oil lubrication.

$F_w$  (50) ~ (58) mm

$\phi E_w$  : Roller set outside diameter

$\phi F_w$  : Roller set bore diameter

Boundary dimensions (mm)			Basic load ratings (kN)		Limiting speeds (min <sup>-1</sup> )	Bearing No.	Special series (Cage)	(Refer.) Mass (g)
$F_w$	$E_w$	$B$	$C_r$	$C_{0r}$	Oil lub.			
<b>50</b>	56	28	39.5	85.5	9 400	<b>RP505628</b>	Welded	69
	56	30	41.0	89.6	9 400	<b>RF505630</b>	Polyamide	50
	57	33.5	47.8	97.1	9 300	<b>RP505734A</b>	—	79
	57	38.9	58.3	126	9 300	<b>RS505739A</b>	—	133
	57	40.8	60.9	133	9 300	<b>RS505741A</b>	—	127
	58	25	38.5	66.9	9 300	<b>RF505825</b>	Polyamide	53
	70	36	114	147	8 300	<b>RF507036</b>	Polyamide	277
	<b>51</b>	56	28	34.8	83.0	9 300	<b>VP51/28</b>	—
<b>52</b>	72	32	108	138	8 100	<b>RF527232</b>	Polyamide	259
<b>53</b>	58	25	32.2	76.0	9 000	<b>RF535825</b>	Polyamide	35
<b>54</b>	60	31.1	45.3	104	8 800	<b>RP546031A</b>	Welded	83
	60	36	45.5	105	8 800	<b>RP546036</b>	Welded, Width tolerance special <sup>1)</sup>	82
	61	34.7	60.2	135	8 700	<b>RPU546135AF</b>	Double split	116
	61	41.3	63.3	143	8 700	<b>RS546141A</b>	—	145
<b>55</b>	59	13	10.8	21.9	8 800	<b>55RFN5913A</b>	Polyamide	11
	60	20	26.7	60.6	8 700	<b>R55/20</b>	—	52
	60	28	35.8	88.4	8 700	<b>RS556028</b>	—	69
<b>56</b>	60	20	24.0	62.4	8 600	<b>RF566020</b>	Polyamide	23
	61	11	13.6	25.6	8 500	<b>RF566111</b>	Polyamide	14
	61	30	39.7	102	8 500	<b>RS566130</b>	Welded	75
	61	33.5	42.5	111	8 500	<b>R56/34</b>	—	85
	<b>58</b>	65	26	42.1	87.1	8 100	<b>58R6526</b>	Width tolerance special <sup>1)</sup>
65		36.6	55.7	125	8 100	<b>58RFN6537A</b>	Polyamide	80
65		36.6	56.4	127	8 100	<b>RS586537A-2</b>	—	145

# Needle roller and cage assemblies

$F_w$  (58) ~ 78 mm

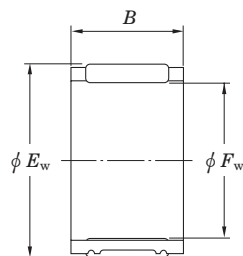

RS, R, RP

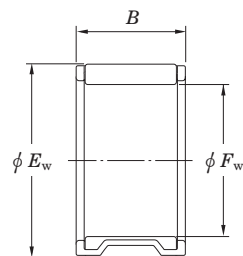

RV, V, VS

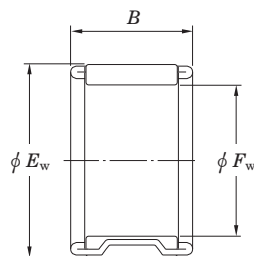

VP, VPS

$\phi E_w$  : Roller set outside diameter  
 $\phi F_w$  : Roller set bore diameter

Boundary dimensions (mm)			Basic load ratings (kN)		Limiting speeds (min <sup>-1</sup> ) Oil lub.	Bearing No.	Special series (Cage)	(Refer.) Mass (g)
$F_w$	$E_w$	$B$	$C_r$	$C_{0r}$				
<b>58</b>	65	37.5	57.7	131	8 100	<b>RP586538A</b>	Welded, Width tolerance special <sup>1)</sup>	108
	80	72	233	359	7 200	<b>RV588072</b>		889
<b>60</b>	65	30	40.0	105	8 000	<b>R60/30</b>	Polyamide	81
	66	19	31.5	67.8	7 900	<b>RS606619</b>		63
	67	23	40.1	82.8	7 900	<b>60V6723</b>		77
	82	30	118	152	7 000	<b>RF608230</b>		316
<b>63</b>	68	30	40.9	110	7 600	<b>R63/30</b>	—	83
<b>64</b>	70	24.5	39.4	92.4	7 500	<b>64R7025A</b>	—	86
	70	35	55.7	144	7 500	<b>64R7035</b>	—	122
<b>65</b>	70	20	12.1	22.3	7 400	<b>R65/20A</b>	—	57
	70	24	12.5	22.9	7 400	<b>R65/24A</b>	—	67
<b>70</b>	76	20	34.7	80.8	6 800	<b>70R7620</b>	—	77
	76	32	55.1	147	6 800	<b>RP707632</b>	Welded	116
	78	30	59.4	132	6 800	<b>70R7830</b>	—	154
<b>71</b>	79	30.15	61.3	138	6 700	<b>71V7930B</b>	—	135
	79	39.5	75.3	179	6 700	<b>RS717940AZ</b>	—	203
<b>72</b>	79	21	39.6	86.6	6 600	<b>72V7921</b>	—	84
<b>73</b>	79	20	36.3	86.8	6 600	<b>R73/20</b>	—	84
<b>78</b>	85	33.75	62.3	159	6 100	<b>78R8534A</b>	—	168

[Note] 1) For further information, consult with JTEKT.

[Remark] Limiting speed of grease lubrication should be kept to under 60 % of that for oil lubrication.

Drawn cup needle roller bearings

$F_w$  4 ~ (12) mm

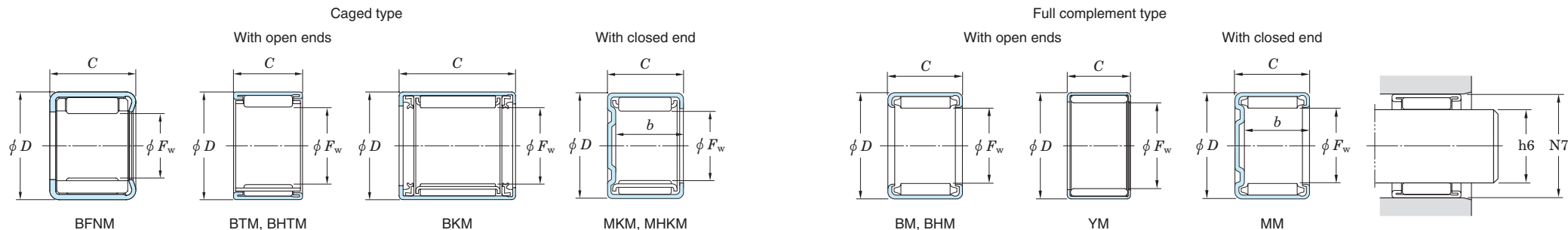

Boundary dimensions (mm)				Basic load ratings (kN)		Limiting speeds (min <sup>-1</sup> )	Bearing No. <sup>2)</sup>				Recommended dimensions (mm)				(Refer.) Mass (g)	
$F_w$	$D$	$C$	$b_{min.}$	$C_r$	$C_{0r}$	Oil lub.	Caged type		Full complement type		Shaft dia. (h6)		Housing bore dia. (N7)		With open ends	With closed end
							With open ends	With closed end	With open ends	With closed end	min.	max.	min.	max.		
4	8	8	—	1.60	1.25	47 000	<b>4BFNM88</b>	—	—	—	3.992	4.000	7.981	7.996	1.3	—
5	9	9	—	2.40	2.15	44 000	<b>5BFNM99</b>	—	—	—	4.992	5.000	8.981	8.996	1.8	—
6	10	9	6	2.40	2.40	42 000	<b>6BTM109</b>	—	—	—	5.992	6.000	9.981	9.996	2.5	—
7	11	9	—	2.55	2.70	39 000	<b>7BTM119</b>	—	—	—	6.991	7.000	10.977	10.995	2.9	—
8	12	10	8.4	3.25	3.85	37 000	<b>8BTM1210</b>	<b>8MKM1210</b>	—	—	7.991	8.000	11.977	11.995	3.6	4.1
	12	10	7.8	4.95	7.50	13 000	—	—	<b>BM081210</b>	<b>8MM1210</b>	7.991	8.000	11.977	11.995	3.7	4.2
	12	10	—	5.25	8.60	13 000	—	—	<b>YM081210</b>	—	7.991	8.000	11.977	11.995	4.0	—
	15	10	8.4	4.00	3.30	34 000	<b>BHTM810</b>	<b>MHKM810</b>	—	—	7.991	8.000	14.977	14.995	6.5	7.3
	15	15	—	7.45	6.50	34 000	<b>BHTM815</b>	—	—	—	7.991	8.000	14.977	14.995	9.4	—
15	20	17.3	9.25	9.70	34 000	<b>BHTM820</b>	<b>MHKM820</b>	—	—	—	7.991	8.000	14.977	14.995	13	14
9	13	10	7.8	4.90	8.05	12 000	—	—	<b>9BM1310</b>	<b>9MM1310</b>	8.991	9.000	12.977	12.995	4.0	4.6
	13	10	8.4	3.35	4.10	35 000	<b>9BTM1310A</b>	<b>9MKM1310</b>	—	—	8.991	9.000	12.977	12.995	3.8	4.3
	13	12	10.4	4.20	5.50	35 000	<b>9BTM1312</b>	<b>9MKM1312</b>	—	—	8.991	9.000	12.977	12.995	4.6	5.2
	16	12	10.4	5.35	5.05	32 000	<b>BHTM912-1</b>	<b>MHKM912</b>	—	—	8.991	9.000	15.977	15.995	8.8	9.9
	16	16	13.3	7.55	7.90	32 000	<b>BHTM916</b>	<b>MHKM916</b>	—	—	8.991	9.000	15.977	15.995	12	13
10	14	10	7.8	5.70	9.35	11 000	—	—	<b>10BM1410</b>	<b>10MM1410</b>	9.991	10.000	13.977	13.995	4.2	4.8
	14	10	8.4	3.55	4.55	33 000	<b>10BTM1410</b>	<b>10MKM1410</b>	—	—	9.991	10.000	13.977	13.995	4.2	4.8
	14	12	10.4	4.40	6.00	33 000	<b>10BTM1412</b>	<b>10MKM1412</b>	—	—	9.991	10.000	13.977	13.995	5.0	5.7
	14	15	11.8	5.65	8.25	33 000	<b>BTM101415</b>	—	—	—	9.991	10.000	13.977	13.995	6.4	—
	17	10	8.4	4.65	4.25	30 000	<b>BHTM1010</b>	<b>MHKM1010</b>	—	—	9.991	10.000	16.977	16.995	7.8	8.9
	17	12	10.4	6.00	5.90	30 000	<b>BHTM1012-1</b>	<b>MHKM1012</b>	—	—	9.991	10.000	16.977	16.995	9.4	11
	17	15	—	7.85	8.45	30 000	<b>BHTM1015</b>	—	—	—	9.991	10.000	16.977	16.995	12	—
	17	20	17.3	10.7	12.5	30 000	<b>BHTM1020</b>	<b>MHKM1020</b>	—	—	9.991	10.000	16.977	16.995	16	18
12	16	10	8.4	4.00	5.60	29 000	<b>12BTM1610</b>	<b>12MKM1610</b>	—	—	11.989	12.000	15.977	15.995	5.0	5.6

[Notes] 1) The limiting speeds shown above are applicable when oil seal is used and the bearing is lubricated with grease.  
 2) FN in bearing number indicates a bearing comprising polyamide molded cage.  
 3) The recommended dimensional tolerances of shaft shown above are applicable except h6.  
 4) The recommended dimensional tolerances of housing bore shown above are applicable except N7.

[Remark] Limiting speed of grease lubrication should be kept to under 60 % of that for oil lubrication.

Drawn cup needle roller bearings

$F_w$  (12) ~ 14.50 mm

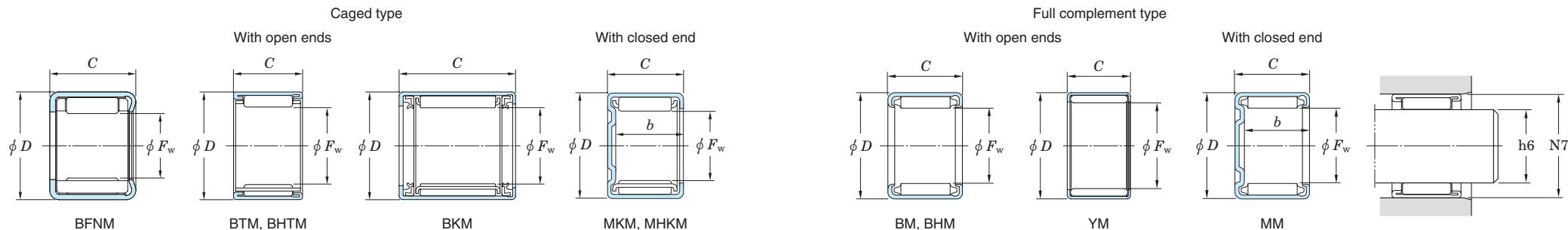

Boundary dimensions (mm)				Basic load ratings (kN)		Limiting speeds (min <sup>-1</sup> )	Bearing No. <sup>2)</sup>				Recommended dimensions (mm)				(Refer.) Mass (g)	
$F_w$	D	C	b min.	$C_r$	$C_{0r}$	Oil lub.	Caged type		Full complement type		Shaft dia. (h6)		Housing bore dia. (N7)		With open ends	With closed end
							With open ends	With closed end	With open ends	With closed end	min.	max.	min.	max.		
<b>12</b>	18	10	8.4	4.60	4.80	27 000	<b>12BTM1810</b>	<b>12MKM1810</b>	—	—	11.989	12.000	17.977	17.995	7.2	8.2
	18	12	9.6	8.40	12.6	9 400	—	—	<b>12BM1812</b>	<b>12MM1812</b>	11.989	12.000	17.977	17.995	9.7	11
	18	12	9.3	5.95	6.70	27 000	<b>12BTM1812</b>	<b>12MKM1812</b>	—	—	11.989	12.000	17.977	17.995	7.6	8.5
	18	15	—	6.10	7.32	27 000	<b>12BTM1815A</b>	—	—	—	11.989	12.000	17.991 <sup>4)</sup>	18.012 <sup>4)</sup>	12	—
	18	16	—	5.65	6.25	16 000 <sup>1)</sup>	<b>12BKM1816UU</b>	—	—	—	11.989	12.000	17.977	17.995	11	—
	19	12	9.3	6.70	6.95	26 000	<b>BHTM1212-1</b>	<b>MHKM1212</b>	—	—	11.989	12.000	18.972	18.993	10	12
	19	15	—	8.85	9.95	26 000	<b>BHTM1215-1</b>	<b>MKM121915</b>	—	—	11.989	12.000	18.972	18.993	13	—
	19	20	17.3	12.1	14.9	26 000	<b>BHTM1220</b>	<b>MHKM1220</b>	—	—	11.989	12.000	18.972	18.993	17	19
	19	25	—	15.0	19.6	26 000	<b>BHTM1225</b>	—	—	—	11.989	12.000	18.972	18.993	21	—
<b>13</b>	17	15	—	5.10	7.85	27 000	<b>BKM131715J</b>	—	—	—	12.989	12.000	16.977	16.995	7.1	—
	19	12	—	8.55	13.4	9 100	—	—	<b>13BM1912</b>	—	12.989	13.000	18.972	18.993	10	—
	19	12	9.3	5.85	6.70	26 000	<b>13BTM1912</b>	<b>13MKM1912</b>	—	—	12.989	13.000	18.972	18.993	9.5	11
	19	14	—	7.65	9.60	26 000	<b>BKM131914J</b>	—	—	—	12.989	13.000	18.972	18.993	11	—
	20	12	—	7.50	8.40	25 000	<b>13BTM2012J</b>	—	—	—	12.989	13.000	19.972	19.993	11	—
	21	14	—	9.75	10.5	25 000	<b>BKM132114BJ</b>	—	—	—	12.989	13.000	20.972	20.993	15	—
<b>13.50</b>	19	12	—	6.25	7.95	25 000	<b>BTM141912A</b>	—	—	—	13.447 <sup>3)</sup>	13.460 <sup>3)</sup>	19.000 <sup>4)</sup>	19.021 <sup>4)</sup>	9.5	—
<b>14</b>	19	16	13.7	11.7	23.3	8 800	—	—	<b>14BM1916</b>	<b>14MM1916</b>	13.989	14.000	18.972	18.993	12	14
	19	16	13.3	7.85	11.7	25 000	<b>14BTM1916B</b>	<b>14MKM1916</b>	—	—	13.983 <sup>3)</sup>	13.994 <sup>3)</sup>	18.972	18.993	11	12
	20	12	9.6	9.15	14.6	8 600	—	—	<b>14BM2012</b>	<b>14MM2012</b>	13.989	14.000	19.972	19.993	11	12
	20	12	9.3	6.10	7.20	25 000	<b>14BTM2012</b>	<b>14MKM2012</b>	—	—	13.989	14.000	19.972	19.993	9.8	11
	20	16	13.7	12.7	22.4	8 600	—	—	<b>14BM2016</b>	<b>14MM2016</b>	13.989	14.000	19.972	19.993	15	17
	20	16	13.3	8.75	11.4	25 000	<b>14BTM2016</b>	<b>14MKM2016</b>	—	—	13.989	14.000	19.972	19.993	13	15
	20	25	—	12.2	15.5	14 000 <sup>1)</sup>	<b>14BKM2025JUJ</b>	—	—	—	13.989	14.000	19.972	19.993	20	—
	22	16	13.3	11.1	12.6	23 000	<b>BHTM1416</b>	<b>MHKM1416</b>	—	—	13.989	14.000	21.972	21.993	19	21
	22	20	17.3	14.4	17.5	23 000	<b>BHTM1420</b>	<b>MHKM1420</b>	—	—	13.989	14.000	21.972	21.993	23	26
<b>14.50</b>	19.50	13.50	—	7.55	10.9	25 000	<b>BTM152014A</b>	—	—	—	14.489	14.500	19.472	19.493	9.5	—

[Notes] 1) The limiting speeds shown above are applicable when oil seal is used and the bearing is lubricated with grease.

2) FN in bearing number indicates a bearing comprising polyamide molded cage.

3) The recommended dimensional tolerances of shaft shown above are applicable except h6.

4) The recommended dimensional tolerances of housing bore shown above are applicable except N7.

[Remark] Limiting speed of grease lubrication should be kept to under 60 % of that for oil lubrication.

# Drawn cup needle roller bearings

$F_w$  15 ~ (17) mm

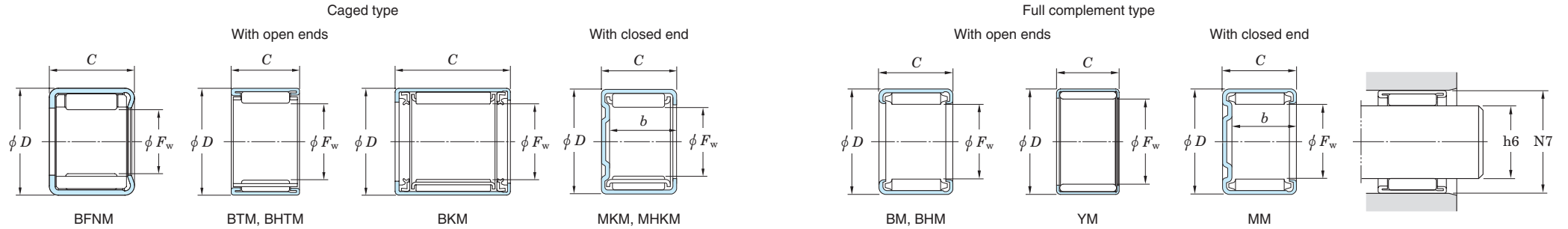

Boundary dimensions (mm)				Basic load ratings (kN)		Limiting speeds (min <sup>-1</sup> )	Bearing No. <sup>2)</sup>				Recommended dimensions (mm)				(Refer.) Mass (g)	
$F_w$	$D$	$C$	$b$ min.	$C_r$	$C_{0r}$		Oil lub.	Caged type		Full complement type		Shaft dia. (h6)		Housing bore dia. (N7)		With open ends
							With open ends	With closed end	With open ends	With closed end	min.	max.	min.	max.		
15	20	16	—	8.15	12.6	24 000	15BTM2016C-2	—	—	—	14.989	15.000	19.991 <sup>4)</sup>	20.012 <sup>4)</sup>	12	—
	21	10	—	7.70	11.8	8 100	—	—	15BM2110	—	14.989	15.000	20.972	20.993	9.4	—
	21	10	—	5.25	6.25	23 000	15BTM2110JA	—	—	—	14.989	15.000	20.991 <sup>4)</sup>	21.012 <sup>4)</sup>	9.5	—
	21	12	9.6	9.70	15.9	8 100	—	—	15BM2112	15MM2112	14.989	15.000	20.972	20.993	12	13
	21	12	9.3	7.00	8.80	23 000	15BTM2112-1	15MKM2112	—	—	14.989	15.000	20.972	20.993	11	12
	21	16	13.7	13.4	24.2	8 100	—	—	15BM2116	15MM2116	14.989	15.000	20.972	20.993	16	18
	21	16	13.3	9.80	13.6	23 000	15BTM2116	15MKM2116	—	—	14.989	15.000	20.972	20.993	14	16
	21	22	—	13.0	19.5	23 000	15BTM2122	—	—	—	14.989	15.000	20.991 <sup>4)</sup>	21.012 <sup>4)</sup>	20	—
	22	10	8.4	6.15	6.45	23 000	BHTM1510	MHKM1510	—	—	14.989	15.000	21.972	21.993	9.9	11
	22	12	9.3	6.90	7.95	23 000	BHTM1512A	MHKM1512	—	—	14.989	15.000	21.991 <sup>4)</sup>	22.012 <sup>4)</sup>	12	14
	22	15	—	10.9	13.3	23 000	BHTM1515-1	—	—	—	14.989	15.000	21.972	21.993	10	—
	22	20	17.3	14.2	18.8	23 000	BHTM1520	MHKM1520	—	—	14.989	15.000	21.972	21.993	20	23
	22	25	—	17.7	25.0	23 000	BHTM1525	—	—	—	14.989	15.000	21.972	21.993	26	—
16	22	12	9.6	10.2	17.1	7 700	—	—	16BM2212	16MM2212	15.989	16.000	21.972	21.993	12	14
	22	12	9.3	7.60	9.80	22 000	16BTM2212A	16MKM2212	—	—	15.989	16.000	21.991 <sup>4)</sup>	22.012 <sup>4)</sup>	11	12
	22	16	13.7	14.1	25.9	7 700	—	—	16BM2216	16MM2216	15.989	16.000	21.972	21.993	17	19
	22	16	13.3	10.7	15.1	22 000	16BTM2216	16MKM2216	—	—	15.989	16.000	21.972	21.993	15	17
	22	22	—	16.2	22.9	22 000	16BTM2222B	—	—	—	15.989	16.000	21.991 <sup>4)</sup>	22.012 <sup>4)</sup>	20	—
	24	12	—	8.00	8.45	21 000	BHTM1612	—	—	—	15.989	16.000	23.972	23.993	15	—
	24	16	13.3	12.2	14.9	21 000	BHTM1616A	MHKM1616	—	—	15.989	16.000	23.991 <sup>4)</sup>	24.012 <sup>4)</sup>	20	23
	24.15	14	12.6	8.45	9.05	12 000 <sup>1)</sup>	—	MKM162414U	—	—	15.989	16.000	24.122	24.143	—	19
17	21.50	15	10.6	6.15	9.60	22 000	17BTM2215	—	—	—	16.989	17.000	21.472	21.493	10	—
	22	10	—	5.05	6.90	21 000	BTM1710	—	—	—	16.989	17.000	21.972	21.993	8.2	—
	22	13	—	10.6	21.6	7 500	—	—	BM1713-1	—	16.989	17.000	21.972	21.993	12	—
	23	12	9.6	10.3	17.9	7 300	—	—	17BM2312	17MM2312	16.989	17.000	22.972	22.993	13	15
	23	12	—	7.65	10.2	21 000	BTM172312	—	—	—	16.989	17.000	22.972	22.993	12	—
	23	20	—	18.0	36.7	7 300	—	—	17BM2320	—	16.989	17.000	22.972	22.993	23	—

[Notes] 1) The limiting speeds shown above are applicable when oil seal is used and the bearing is lubricated with grease.

2) FN in bearing number indicates a bearing comprising polyamide molded cage.

3) The recommended dimensional tolerances of shaft shown above are applicable except h6.

4) The recommended dimensional tolerances of housing bore shown above are applicable except N7.

[Remark] Limiting speed of grease lubrication should be kept to under 60 % of that for oil lubrication.

$F_w$  (17) ~ 19 mm

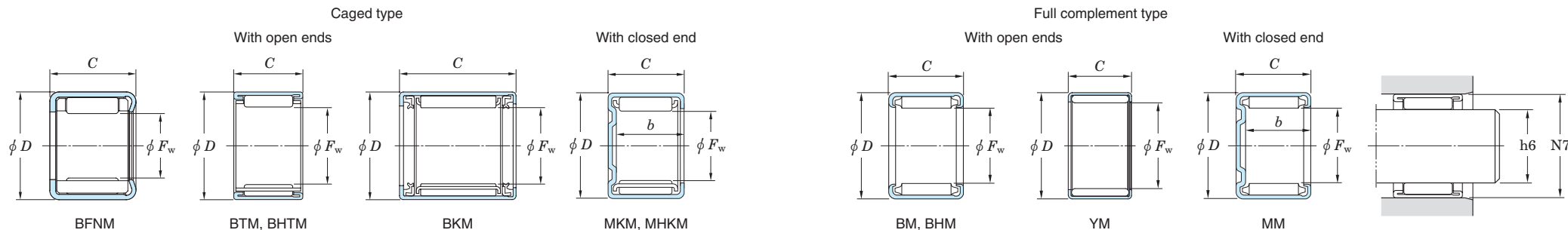

$F_w$	Boundary dimensions (mm)			Basic load ratings (kN)		Limiting speeds (min <sup>-1</sup> ) Oil lub.	Bearing No. <sup>2)</sup>		Recommended dimensions (mm)				(Refer.) Mass (g)				
	$D$	$C$	$b$ min.	$C_r$	$C_{0r}$		With open ends	With closed end	With open ends	With closed end	Shaft dia. (h6) min. max.	Housing bore dia. (N7) min. max.	With open ends	With closed end			
17	24	12	—	12.8	21.0	7 200	—	—	<b>YM172412-1</b>	—	16.983 <sup>3)</sup>	16.994 <sup>3)</sup>	23.985 <sup>4)</sup>	24.006 <sup>4)</sup>	17	—	
	24	15	—	11.2	14.8	20 000	<b>BHTM1715-1</b>	—	—	—	16.989	17.000	23.972	23.993	17	—	
	24	17	—	16.0	27.9	7 200	—	—	<b>BM172417-1</b>	—	16.989	17.000	23.991 <sup>4)</sup>	24.012 <sup>4)</sup>	23	—	
	24	20	—	12.9	17.6	11 000 <sup>1)</sup>	<b>BHKM1720JBU</b>	—	—	—	16.989	17.000	23.972	23.993	22	—	
	24	20	—	19.0	21.9	7 200	—	—	<b>BHM1720A</b>	—	16.983 <sup>3)</sup>	16.994 <sup>3)</sup>	23.985 <sup>4)</sup>	24.006 <sup>4)</sup>	27	—	
	24	20	17.3	15.1	21.6	20 000	<b>BHTM1720-1</b>	<b>MHKM1720</b>	—	—	16.989	17.000	23.972	23.993	24	27	
	24	25	—	23.8	46.6	7 200	—	—	<b>BHM1725</b>	—	16.989	17.000	23.991 <sup>4)</sup>	24.012 <sup>4)</sup>	35	—	
	24	25	—	19.0	29.0	20 000	<b>BTM172425</b>	—	—	—	16.983 <sup>3)</sup>	16.994 <sup>3)</sup>	23.972	23.993	22	—	
	24	26	—	16.0	23.3	11 000 <sup>1)</sup>	<b>BHKM1726JUJ</b>	—	—	—	16.999	17.000	23.972	23.993	29	—	
	24	30	—	20.1	31.3	11 000 <sup>1)</sup>	<b>BHKM1730JU</b>	—	—	—	16.989	17.000	23.972	23.993	35	—	
	25	14	—	7.30	7.90	11 000 <sup>1)</sup>	<b>BKM172514UH-1</b>	—	—	—	16.989	17.000	24.991 <sup>4)</sup>	25.012 <sup>4)</sup>	18	—	
	25	15	—	10.9	13.1	20 000	<b>BKM172515</b>	—	—	—	16.989	17.000	24.991 <sup>4)</sup>	25.012 <sup>4)</sup>	20	—	
	25	16.70	—	7.30	7.90	11 000 <sup>1)</sup>	<b>17BKM2517JBUUH</b>	—	—	—	16.989	17.000	24.972	24.993	20	—	
	25	18	—	10.9	13.1	11 000 <sup>1)</sup>	<b>BKM172518UH</b>	—	—	—	16.989	17.000	24.991 <sup>4)</sup>	25.012 <sup>4)</sup>	24	—	
	25	20	—	12.9	16.3	11 000 <sup>1)</sup>	<b>BKM172520UH-1</b>	—	—	—	16.989	17.000	24.991 <sup>4)</sup>	25.012 <sup>4)</sup>	27	—	
18	24	12	9.6	10.8	19.2	6 900	—	—	<b>18BM2412</b>	<b>18MM2412</b>	17.989	18.000	23.972	23.993	17	20	
	24	12	—	7.90	10.9	20 000	<b>18BTM2412</b>	—	—	—	17.989	18.000	23.991 <sup>4)</sup>	24.012 <sup>4)</sup>	12	—	
	24	16	13.7	16.5	29.1	6 900	—	—	<b>18BM2416</b>	<b>18MM2416</b>	17.989	18.000	23.972	23.993	18	21	
	24	16	—	17.2	30.7	6 900	—	—	<b>18YM2416</b>	—	17.989	18.000	23.972	23.993	19	—	
	24	16	—	11.1	16.8	20 000	<b>BTM182416</b>	—	—	—	17.989	18.000	23.972	23.993	17	—	
	25	13	—	9.40	11.8	19 000	<b>BTM1813</b>	—	—	—	17.989	18.000	24.972	24.993	15	—	
	25	15	—	10.4	9.25	19 000	<b>BTM1815</b>	—	—	—	17.989	18.000	24.972	24.993	18	—	
	25	17	—	12.2	17.7	19 000	<b>BTM1817A</b>	—	—	—	17.989	18.000	24.991 <sup>4)</sup>	25.012 <sup>4)</sup>	20	—	
	25	19	—	14.4	20.5	19 000	<b>BTM1819</b>	—	—	—	17.989	18.000	24.972	24.993	22	—	
	25	20	17.3	15.2	22.1	19 000	<b>BTM182520</b>	<b>MKM1820</b>	—	—	17.989	18.000	24.972	24.993	24	27	
25	25	—	18.9	29.2	19 000	<b>BTM1825A</b>	—	—	—	17.989	18.000	24.972	24.993	29	—		
19	27	20	—	17.0	23.4	18 000	<b>BHTM1920</b>	—	—	—	—	18.987	19.000	26.972	26.993	30	—

[Notes] 1) The limiting speeds shown above are applicable when oil seal is used and the bearing is lubricated with grease.

2) FN in bearing number indicates a bearing comprising polyamide molded cage.

3) The recommended dimensional tolerances of shaft shown above are applicable except h6.

4) The recommended dimensional tolerances of housing bore shown above are applicable except N7.

[Remark] Limiting speed of grease lubrication should be kept to under 60 % of that for oil lubrication.



# Drawn cup needle roller bearings

$F_w$  19.50 ~ (22) mm

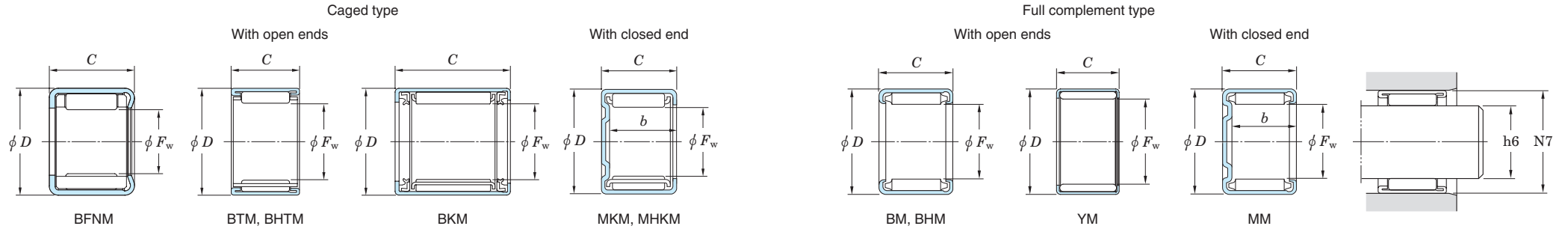

Boundary dimensions (mm)				Basic load ratings (kN)		Limiting speeds (min <sup>-1</sup> )	Bearing No. <sup>2)</sup>				Recommended dimensions (mm)				(Refer.) Mass (g)		
$F_w$	$D$	$C$	$b_{min.}$	$C_r$	$C_{0r}$		Oil lub.	Caged type		Full complement type		Shaft dia. (h6)		Housing bore dia. (N7)		With open ends	With closed end
							With open ends	With closed end	With open ends	With closed end	min.	max.	min.	max.			
19.50	29	20	—	18.8	23.6	17 000	<b>20BTM2920</b>	—	—	—	19.487	19.500	28.972	28.993	36	—	
20	26	12	9.6	10.6	20.4	6 300	—	—	<b>20BM2612</b>	<b>20MM2612</b>	19.987	20.000	25.972	25.993	15	17	
	26	12	9.3	8.50	12.6	18 000	<b>20BTM2612</b>	<b>20MKM2612</b>	—	—	19.987	20.000	25.972	25.993	14	16	
	26	14	—	15.1	31.4	6 300	—	—	<b>YM202614</b>	—	19.987	20.000	25.972	25.993	19	—	
	26	16	13.7	14.8	31.4	6 300	—	—	<b>20BM2616</b>	<b>20MM2616</b>	19.987	20.000	25.972	25.993	21	23	
	26	16	13.3	12.4	20.3	18 000	<b>BTM202616</b>	<b>20MKM2616</b>	—	—	19.987	20.000	25.972	25.993	19	21	
	26	20	17.2	18.8	42.5	6 300	—	—	<b>20BM2620</b>	<b>20MM2620</b>	19.987	20.000	25.972	25.993	26	30	
	26	20	—	15.2	26.4	18 000	<b>20BTM2620A</b>	—	—	—	—	19.987	20.000	25.972	25.993	24	—
	27	13	10.6	13.1	22.2	6 200	—	—	<b>BM2013</b>	<b>MM2013</b>	19.987	20.000	26.972	26.993	18	21	
	27	15	—	15.6	27.7	6 200	—	—	<b>BM2015</b>	—	19.987	20.000	26.972	26.993	22	—	
	27	15	—	13.1	18.7	18 000	<b>BTM2015</b>	—	—	—	—	19.870	20.000	26.972	26.993	20	—
	27	20	17.3	17.7	27.6	18 000	<b>BTM202720-1</b>	<b>MKM2020</b>	—	—	19.987	20.000	26.972	26.993	25	28	
	27	23.50	—	18.4	28.8	10 000 <sup>1)</sup>	<b>BKM2024JAU</b>	—	—	—	—	19.987	20.000	26.972	26.993	32	—
	27	25	—	22.1	36.6	18 000	<b>BTM202725</b>	—	—	—	—	19.987	20.000	26.972	26.993	33	—
	27	26	—	18.4	28.8	10 000 <sup>1)</sup>	<b>BKM2026JUU</b>	—	—	—	—	19.987	20.000	26.972	26.993	33	—
	27	26	—	27.6	58.0	6 200	—	—	<b>BM2026</b>	—	19.987	20.000	26.972	26.993	40	—	
	27	30	—	21.8	36.0	10 000 <sup>1)</sup>	<b>BKM2030JUU</b>	—	—	—	—	19.987	20.000	26.972	26.993	38	—
27	30	27.3	25.4	43.8	18 000	<b>BTM202730</b>	<b>MKM2030</b>	—	—	19.987	20.000	26.972	26.993	40	45		
27	35	—	28.7	45.4	10 000 <sup>1)</sup>	<b>BKM2035JUU</b>	—	—	—	—	19.987	20.000	26.972	26.993	45	—	
28	20	—	17.4	22.3	17 000	<b>20BTM2820A</b>	—	—	—	—	19.987	20.000	27.991 <sup>4)</sup>	28.012 <sup>4)</sup>	31	—	
21	27	20	—	20.5	47.6	6 100	—	—	<b>21YM2720J</b>	—	20.987	21.000	26.972	26.993	29	—	
22	28	12	9.6	11.6	22.9	5 800	—	—	<b>22BM2812</b>	<b>22MM2812</b>	21.987	22.000	27.972	27.993	16	18	
	28	12	9.3	9.10	13.5	16 000	<b>22BTM2812</b>	<b>22MKM2812</b>	—	—	21.987	22.000	27.972	27.993	14	16	
	28	16	13.7	16.1	35.0	5 800	—	—	<b>22BM2816</b>	<b>22MM2816</b>	21.987	22.000	27.972	27.993	22	25	
	28	16	13.3	12.7	20.8	16 000	<b>22BTM2816A</b>	<b>22MKM2816</b>	—	—	21.987	22.000	27.972	27.993	19	22	
	28	20	17.2	20.3	47.2	5 800	—	—	<b>22BM2820</b>	<b>22MM2820</b>	21.987	22.000	27.972	27.993	29	32	

[Notes] 1) The limiting speeds shown above are applicable when oil seal is used and the bearing is lubricated with grease.  
 2) FN in bearing number indicates a bearing comprising polyamide molded cage.  
 3) The recommended dimensional tolerances of shaft shown above are applicable except h6.  
 4) The recommended dimensional tolerances of housing bore shown above are applicable except N7.

[Remark] Limiting speed of grease lubrication should be kept to under 60 % of that for oil lubrication.

Drawn cup needle roller bearings

$F_w$  (22) ~ (25) mm

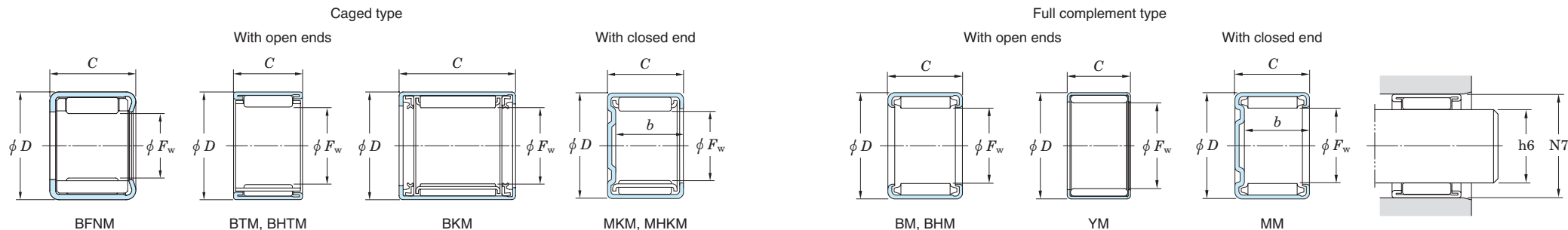

Boundary dimensions (mm)				Basic load ratings (kN)		Limiting speeds (min <sup>-1</sup> )	Bearing No. <sup>2)</sup>				Recommended dimensions (mm)				(Refer.) Mass (g)	
$F_w$	$D$	$C$	$b_{min.}$	$C_r$	$C_{0r}$	Oil lub.	Caged type		Full complement type		Shaft dia. (h6)		Housing bore dia. (N7)		With open ends	With closed end
							With open ends	With closed end	With open ends	With closed end	min.	max.	min.	max.		
22	28	20	17.3	14.9	26.5	17 000	<b>22BTM2820</b>	<b>22MKM2820</b>	—	—	21.987	22.000	27.972	27.993	25	28
	28	20	—	21.0	49.5	5 800	—	—	<b>YM222820</b>	—	21.987	22.000	27.972	27.993	30	—
	29	12	—	9.22	13.0	16 000	<b>BTM2212</b>	—	—	—	21.987	22.000	28.972	28.993	19	—
	29	15	—	12.0	18.3	16 000	<b>BTM2215</b>	—	—	—	21.987	22.000	28.972	28.993	22	—
	29	20	—	21.9	45.2	5 700	—	—	<b>BM2220B</b>	—	21.987	22.000	28.972	28.993	33	—
	29	20	17.3	16.2	26.7	16 000	<b>BTM2220A</b>	<b>MKM2220</b>	—	—	21.987	22.000	28.972	28.993	30	33
	29	25	—	20.4	36.1	16 000	<b>BTM2225</b>	—	—	—	21.987	22.000	28.972	28.993	37	—
	30	18	—	16.7	24.5	16 000	<b>22BTM3018</b>	—	—	—	21.987	22.000	29.972	29.993	31	—
24	30	13	—	9.55	15.7	15 000	<b>BTM243013J</b>	—	—	—	23.987	24.000	29.991 <sup>4)</sup>	30.012 <sup>4)</sup>	47	—
	31	20	17.3	17.7	29.4	15 000	<b>BTM2420</b>	<b>MKM2420</b>	—	—	23.987	24.000	30.967	30.992	31	35
	31	25	—	31.6	65.4	5 200	—	—	<b>BM2425A</b>	—	23.987	24.000	30.989 <sup>4)</sup>	31.014 <sup>4)</sup>	45	—
	31	28	—	23.9	43.0	15 000	<b>BTM2428</b>	—	—	—	23.987	24.000	30.967	30.992	44	—
	35	20	18.0	21.0	25.8	14 000	—	<b>24MKM3520</b>	—	—	23.987	24.000	34.967	34.992	—	52
25	31	19	—	16.3	30.1	15 000	<b>25BTM3119A</b>	—	—	—	24.987	25.000	30.967	30.992	26	—
	32	12	9.3	9.05	12.4	14 000	<b>BTM2512</b>	<b>MKM2512</b>	—	—	24.987	25.000	31.967	31.992	19	21
	32	16	—	18.7	37.9	5 100	—	—	<b>BM2516</b>	—	24.987	25.000	31.967	31.992	28	—
	32	16	13.3	15.3	24.6	14 000	<b>BTM2516</b>	<b>MKM2516</b>	—	—	24.987	25.000	31.967	31.992	26	30
	32	20	17.2	23.8	51.7	5 100	—	—	<b>BM2520</b>	<b>MM2520</b>	24.987	25.000	31.967	31.992	36	41
	32	20	—	19.1	32.5	14 000	<b>BTM2520A</b>	<b>MTM2520M</b>	—	—	24.987	25.000	31.967	31.992	33	—
	32	26	—	30.9	72.4	5 100	—	—	<b>BM2526</b>	—	24.987	25.000	31.967	31.992	48	—
	32	26	23.3	23.7	43.1	14 000	<b>BTM2526</b>	<b>MKM2526</b>	—	—	24.987	25.000	31.967	31.992	42	48
	33	10	—	8.50	10.3	14 000	<b>BHTM2510A</b>	—	—	—	24.987	25.000	32.989 <sup>4)</sup>	33.014 <sup>4)</sup>	18	—
	33	15	—	19.5	32.0	5 000	—	—	<b>BHM2515</b>	—	24.987	25.000	32.989 <sup>4)</sup>	33.014 <sup>4)</sup>	30	—
	33	15	—	13.9	19.7	14 000	<b>BHTM2515-1</b>	—	—	—	24.987	25.000	32.967	32.992	27	—
	33	20	17.3	19.2	29.7	14 000	<b>BHTM2520-1</b>	<b>MHKM2520</b>	—	—	24.987	25.000	32.967	32.992	37	41
	33	25	—	31.3	66.3	5 000	—	—	<b>BHM2525</b>	—	24.987	25.000	32.967	32.992	53	—
	33	25	—	24.5	40.6	14 000	<b>BHTM2525</b>	—	—	—	24.987	25.000	32.967	32.992	46	—

[Notes] 1) The limiting speeds shown above are applicable when oil seal is used and the bearing is lubricated with grease.

2) FN in bearing number indicates a bearing comprising polyamide molded cage.

3) The recommended dimensional tolerances of shaft shown above are applicable except h6.

4) The recommended dimensional tolerances of housing bore shown above are applicable except N7.

[Remark] Limiting speed of grease lubrication should be kept to under 60 % of that for oil lubrication.

Drawn cup needle roller bearings

$F_w$  (25) ~ (30) mm

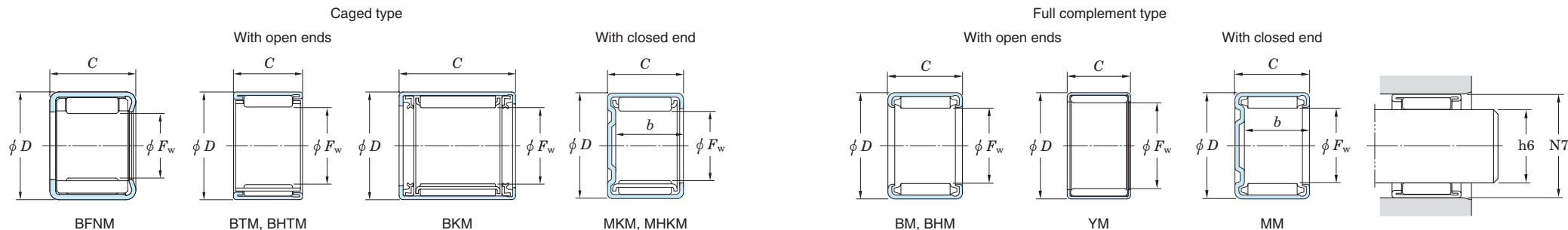

Boundary dimensions (mm)				Basic load ratings (kN)		Limiting speeds (min <sup>-1</sup> )	Bearing No. <sup>2)</sup>				Recommended dimensions (mm)				(Refer.) Mass (g)	
$F_w$	$D$	$C$	$b_{min.}$	$C_r$	$C_{0r}$	Oil lub.	Caged type		Full complement type		Shaft dia. (h6)		Housing bore dia. (N7)		With open ends	With closed end
							With open ends	With closed end	With open ends	With closed end	min.	max.	min.	max.		
<b>25</b>	33	30	—	37.4	83.3	5 000	—	—	<b>BHM2530</b>	—	24.987	25.000	32.989 <sup>4)</sup>	33.014 <sup>4)</sup>	65	—
	33	30	27.3	27.7	47.4	14 000	<b>BHTM2530-1</b>	<b>MHKM2530</b>	—	—	24.987	25.000	32.967	32.992	54	61
	33	35	—	29.8	52.3	8 000 <sup>1)</sup>	<b>BHKM2535JU</b>	—	—	—	24.987	25.000	32.967	32.992	62	—
<b>25.80</b>	33	16	—	14.2	22.4	14 000	<b>BTM263316A</b>	—	—	—	25.787	25.800	32.967	32.992	28	—
<b>26</b>	31.40	12	—	8.60	14.5	14 000	<b>BKM263112A</b>	—	—	—	25.987	26.000	31.389 <sup>4)</sup>	31.414 <sup>4)</sup>	14	—
	34	16	13.3	15.3	22.5	14 000	<b>BHTM2616</b>	<b>MHKM2616</b>	—	—	25.987	26.000	33.967	33.992	30	34
	34	20	17.3	20.0	31.6	14 000	<b>BHTM2620A</b>	<b>MHKM2620</b>	—	—	25.987	26.000	33.967	33.992	38	43
<b>28</b>	34	17	—	16.8	49.7	4 600	—	—	<b>BM2817</b>	—	27.987	28.000	33.967	33.992	29	—
	34	24	—	29.0	76.7	4 600	—	—	<b>BM2824</b>	—	27.987	28.000	33.967	33.992	42	—
	34	25	—	34.8	85.9	4 600	—	—	<b>YM2825B</b>	—	27.991 <sup>3)</sup>	28.000 <sup>3)</sup>	33.975 <sup>4)</sup>	34.000 <sup>4)</sup>	45	—
	35	16	13.7	20.2	42.9	4 600	—	—	<b>28BM3516</b>	<b>28MM3516</b>	27.987	28.000	34.967	34.992	95	107
	35	16	13.3	15.9	26.2	13 000	<b>28BTM3516</b>	<b>28MKM3516</b>	—	—	27.987	28.000	34.967	34.992	28	31
	35	20	17.2	25.7	58.3	4 600	—	—	<b>28BM3520</b>	<b>28MM3520</b>	27.987	28.000	34.967	34.992	118	133
	35	20	17.3	19.0	33.1	13 000	<b>28BTM3520</b>	<b>28MKM3520</b>	—	—	27.987	28.000	34.967	34.992	35	39
	36	20.75	—	22.8	39.3	13 000	<b>BTM283621JA</b>	—	—	—	27.987	28.000	35.967	35.992	43	—
	36	23	—	22.8	39.3	13 000	<b>BTM283623J</b>	—	—	—	27.987	28.000	35.967	35.992	49	—
	37	20	17.3	21.6	33.0	13 000	<b>BTM283720</b>	<b>MHKM2820</b>	—	—	27.987	28.000	36.967	36.992	46	52
	37	30	—	43.7	94.7	4 400	—	—	<b>28BHM3730</b>	—	27.980 <sup>3)</sup>	27.993 <sup>3)</sup>	36.989 <sup>4)</sup>	37.014 <sup>4)</sup>	80	—
	37	30	27.3	32.8	56.5	13 000	<b>BHTM2830</b>	<b>MHKM2830</b>	—	—	27.987	28.000	36.967	36.992	70	79
	39	30	—	44.5	85.9	4 300	—	—	<b>BM283930A</b>	—	27.980 <sup>3)</sup>	27.993 <sup>3)</sup>	38.989 <sup>4)</sup>	39.014 <sup>4)</sup>	100	—
<b>30</b>	37	12	9.3	12.1	18.8	12 000	<b>BTM303712</b>	<b>30MKM3712</b>	—	—	29.987	30.000	36.967	36.992	22	25
	37	16	—	21.1	28.2	4 300	—	—	<b>30BM3716</b>	—	29.987	30.000	36.967	36.992	33	—
	37	16	13.3	17.1	29.3	12 000	<b>30BTM3716BM</b>	<b>30MKM3716</b>	—	—	29.987	30.000	36.967	36.992	30	33
	37	20	17.2	26.8	62.5	4 300	—	—	<b>30BM3720</b>	<b>30MM3720</b>	29.987	30.000	36.967	36.992	42	48
	37	20	17.3	20.7	40.4	12 000	<b>30BTM3720</b>	<b>30MKM3720</b>	—	—	29.987	30.000	36.967	36.992	40	45
	37	20	—	32.2	70.1	4 300	—	—	<b>30YM3720</b>	—	29.987	30.000	36.967	36.992	45	—

[Notes] 1) The limiting speeds shown above are applicable when oil seal is used and the bearing is lubricated with grease.

2) FN in bearing number indicates a bearing comprising polyamide molded cage.

3) The recommended dimensional tolerances of shaft shown above are applicable except h6.

4) The recommended dimensional tolerances of housing bore shown above are applicable except N7.

[Remark] Limiting speed of grease lubrication should be kept to under 60 % of that for oil lubrication.

Drawn cup needle roller bearings

$F_w$  (30) ~ (35) mm

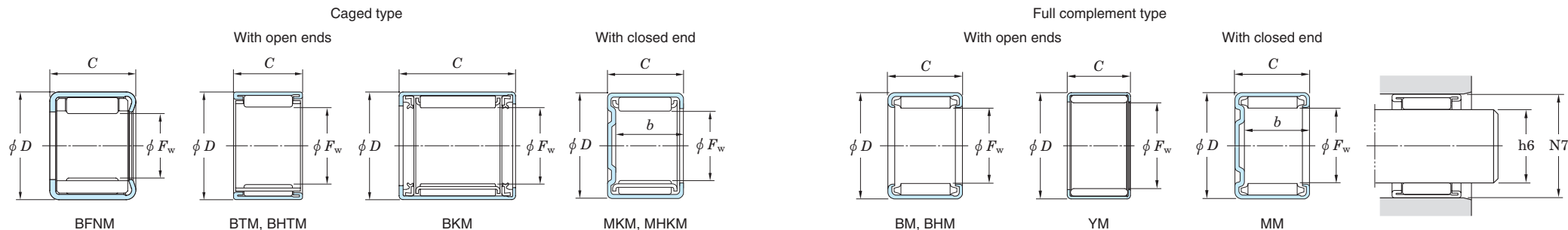

Boundary dimensions (mm)				Basic load ratings (kN)		Limiting speeds (min <sup>-1</sup> )	Bearing No. <sup>2)</sup>				Recommended dimensions (mm)				(Refer.) Mass (g)	
$F_w$	$D$	$C$	$b$ min.	$C_r$	$C_{0r}$	Oil lub.	Caged type		Full complement type		Shaft dia. (h6)		Housing bore dia. (N7)		With open ends	With closed end
							With open ends	With closed end	With open ends	With closed end	min.	max.	min.	max.		
30	37	26	—	34.8	87.3	4 300	—	—	<b>30BM3726</b>	—	29.987	30.000	36.967	36.992	56	—
	37	26	23.3	26.7	52.0	12 000	<b>30BTM3726</b>	<b>30MKM3726</b>	—	—	29.987	30.000	36.967	36.992	48	55
	37	26	—	37.1	94.9	4 300	—	—	<b>30YM3726</b>	—	29.987	30.000	36.967	36.992	60	—
	38	21	—	23.4	40.4	12 000	<b>BTM3021A</b>	—	—	—	29.987	30.000	37.967	37.992	45	—
	38	25	—	38.0	79.8	4 200	—	—	<b>BM3025</b>	—	29.987	30.000	37.989 <sup>4)</sup>	38.014 <sup>4)</sup>	62	—
	40	15	—	16.6	22.3	12 000	<b>BHTM3015</b>	—	—	—	29.987	30.000	39.967	39.992	41	—
	40	20	17.3	23.1	34.0	12 000	<b>BHTM3020</b>	<b>MHKM3020</b>	—	—	29.987	30.000	39.967	39.992	55	62
	40	25	—	37.3	75.4	4 100	—	—	<b>BHM3025</b>	—	29.987	30.000	39.987 <sup>4)</sup>	40.013 <sup>4)</sup>	80	—
	40	25	—	29.4	46.5	12 000	<b>BHTM3025-1</b>	—	—	—	29.987	30.000	39.967	39.992	69	—
	40	30	27.3	35.3	58.8	12 000	<b>BHTM3030-1A</b>	<b>MHKM3030</b>	—	—	29.987	30.000	39.967	39.992	83	94
40	30	—	30.8	49.3	6 600 <sup>1)</sup>	<b>BKM304030JU</b>	—	—	—	29.987	30.000	39.967	39.992	77	—	
31	39	17.80	—	20.6	34.6	12 000	<b>31BTM3918A</b>	—	—	—	30.984	31.000	38.967	38.992	39	—
32	38	11	—	4.90	6.75	12 000	<b>32BTM3811A</b>	—	—	—	31.975 <sup>3)</sup>	31.991 <sup>3)</sup>	38.000 <sup>4)</sup>	38.025 <sup>4)</sup>	15	—
	40	20	—	31.9	73.3	4 000	—	—	<b>32YM4020P</b>	—	31.984	32.000	39.989 <sup>4)</sup>	40.014 <sup>4)</sup>	56	—
	40	25	—	27.6	50.8	11 000	<b>32BTM4025PL</b>	—	—	—	31.984	32.000	39.989 <sup>4)</sup>	40.014 <sup>4)</sup>	57	—
	42	20	17.3	23.4	34.8	11 000	<b>BHTM3220A</b>	<b>MHKM3220</b>	—	—	31.984	32.000	41.989 <sup>4)</sup>	42.014 <sup>4)</sup>	57	64
	42	20	—	37.4	69.1	3 900	—	—	<b>YM3220</b>	—	31.995 <sup>3)</sup>	32.011 <sup>3)</sup>	41.989 <sup>4)</sup>	42.014 <sup>4)</sup>	71	—
	42	30	27.3	36.6	61.9	11 000	<b>BHTM3230</b>	<b>MHKM3230</b>	—	—	31.984	32.000	41.967	41.992	86	98
42	30	—	55.0	113	3 900	—	—	<b>YM3230</b>	—	31.995 <sup>3)</sup>	32.011 <sup>3)</sup>	41.989 <sup>4)</sup>	42.014 <sup>4)</sup>	109	—	
33.50	40	17	—	16.8	33.5	11 000	<b>BTM344017A</b>	—	—	—	33.484	33.500	39.967	39.992	34	—
34	40	12	—	7.30	11.7	11 000	<b>34BTM4012A</b>	—	—	—	33.984	34.000	39.967	39.992	20	—
	42	25	—	37.2	94.1	3 800	—	—	<b>34YM4225</b>	—	33.959 <sup>3)</sup>	33.975 <sup>3)</sup>	41.967	41.992	74	—
35	40.50	26	—	22.7	56.0	11 000	<b>BSM354126AJ</b>	—	—	—	34.984	35.000	40.467	40.492	44	—
	42	12	—	13.3	22.8	11 000	<b>BTM3512</b>	—	—	—	34.984	35.000	41.967	41.992	26	—
	42	16	—	22.2	52.9	3 700	—	—	<b>BM3516</b>	—	34.984	35.000	41.967	41.992	38	—

[Notes] 1) The limiting speeds shown above are applicable when oil seal is used and the bearing is lubricated with grease.  
 2) FN in bearing number indicates a bearing comprising polyamide molded cage.  
 3) The recommended dimensional tolerances of shaft shown above are applicable except h6.  
 4) The recommended dimensional tolerances of housing bore shown above are applicable except N7.

[Remark] Limiting speed of grease lubrication should be kept to under 60 % of that for oil lubrication.

Drawn cup needle roller bearings

$F_w$  (35) ~ (40) mm

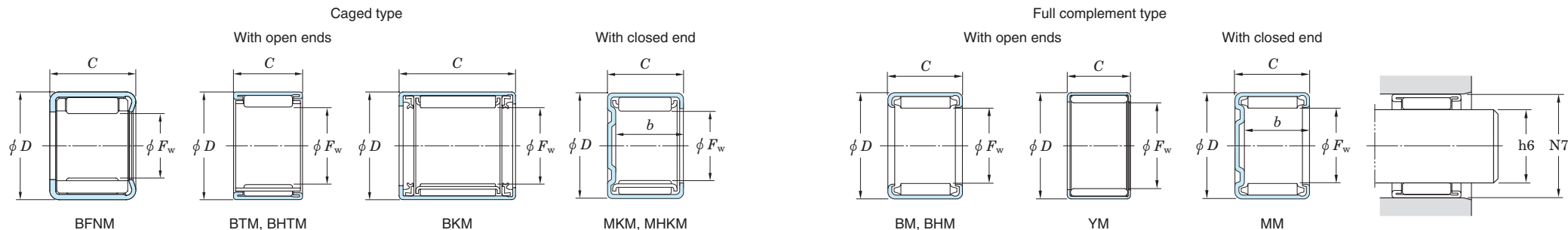

$F_w$	Boundary dimensions (mm)			Basic load ratings (kN)		Limiting speeds (min <sup>-1</sup> ) Oil lub.	Bearing No. <sup>2)</sup>				Recommended dimensions (mm)				(Refer.) Mass (g)	
	$D$	$C$	$b$ min.	$C_r$	$C_{0r}$		Caged type		Full complement type		Shaft dia. (h6)		Housing bore dia. (N7)		With open ends	With closed end
							With open ends	With closed end	With open ends	With closed end	min.	max.	min.	max.		
35	42	16	13.3	18.5	34.7	11 000	<b>BTM3516</b>	<b>MKM3516</b>	—	—	34.984	35.000	41.967	41.992	35	39
	42	20	—	13.3	22.8	5 700 <sup>1)</sup>	<b>BKM354220-1UU</b>	—	—	—	34.984	35.000	41.967	41.992	38	—
	42	20	17.2	28.2	72.2	3 700	—	—	<b>BM3520</b>	<b>MM3520</b>	34.984	35.000	41.967	41.992	49	56
	42	20	17.3	23.4	47.0	11 000	<b>BTM3520</b>	<b>MKM3520</b>	—	—	34.984	35.000	41.989 <sup>4)</sup>	42.014 <sup>4)</sup>	43	49
	42	21	—	28.8	79.2	3 700	—	—	<b>YM3521A</b>	—	34.984	35.000	41.989 <sup>4)</sup>	42.014 <sup>4)</sup>	55	—
	42	26	—	36.7	101	3 700	—	—	<b>BM3526</b>	—	34.984	35.000	41.967	41.992	66	—
	42	26	23.3	30.1	65.2	11 000	<b>BTM3526</b>	<b>MKM3526</b>	—	—	34.984	35.000	41.967	41.992	57	64
	42	28	—	31.3	68.6	11 000	<b>BTM3528</b>	—	—	—	34.984	35.000	41.967	41.992	63	—
	42	46	—	26.2	57.5	5 700 <sup>1)</sup>	<b>BKM354246UUH</b>	—	—	—	34.984	35.000	41.967	41.992	101	—
	45	15	—	18.4	26.6	10 000	<b>BHTM3515</b>	—	—	—	34.984	35.000	44.967	44.992	47	—
	45	18	—	20.5	33.4	3 600	—	—	<b>BHM3518</b>	—	34.984	35.000	44.967	44.992	62	—
	45	20	17.3	26.0	41.7	10 000	<b>BHTM3520</b>	<b>MHKM3520</b>	—	—	34.984	35.000	44.967	44.992	64	72
	45	25	—	32.8	56.2	10 000	<b>BHTM3525</b>	—	—	—	34.984	35.000	44.967	44.992	80	—
45	30	27.3	39.4	71.0	10 000	<b>BHTM3530</b>	<b>MHKM3530</b>	—	—	34.984	35.000	44.967	44.992	96	109	
36	42	16	—	19.6	55.9	3 700	—	—	<b>36BM4216</b>	—	35.984	36.000	41.967	41.992	35	—
	44	25	—	42.0	99.2	3 600	—	—	<b>36YM4425L</b>	—	35.975 <sup>3)</sup>	35.991 <sup>3)</sup>	43.967	43.992	78	—
	48	24	—	33.2	48.7	9 800	<b>36BTM4824</b>	—	—	—	35.984	36.000	47.967	47.992	95	—
37	43	12	—	8.00	13.6	10 000	<b>37BTM4312A</b>	—	—	—	36.984	37.000	42.967	42.992	23	—
	47	20	17.3	25.1	39.9	9 800	<b>BTM3720</b>	<b>MKM3720</b>	—	—	36.984	37.000	46.967	46.992	64	72
	47	30	27.3	38.2	68.4	9 800	<b>BTM3730</b>	<b>MKM3730</b>	—	—	36.984	37.000	46.967	46.992	96	109
38	45	12	—	12.7	23.0	9 800	<b>BTM384512A</b>	—	—	—	37.984	38.000	44.967	44.992	29	—
	48	20	17.3	27.1	44.5	9 500	<b>BTM3820A</b>	<b>MKM3820</b>	—	—	37.984	38.000	47.967	47.992	67	76
	48	20	—	42.0	82.8	3 300	—	—	<b>YM3820P</b>	—	37.984	38.000	47.967	47.992	82	—
	48	30	27.3	41.2	76.2	9 500	<b>BTM3830PL</b>	<b>MKM3830</b>	—	—	37.984	38.000	47.967	47.992	102	115
	48	45	—	58.9	121	9 500	<b>BTM3845-OH</b>	—	—	—	37.984	38.000	47.967	47.992	151	—
40	47	12	—	9.75	10.4	9 400	<b>40BTM4712A</b>	—	—	—	39.984	40.000	46.967	46.992	27	—

[Notes] 1) The limiting speeds shown above are applicable when oil seal is used and the bearing is lubricated with grease.

2) FN in bearing number indicates a bearing comprising polyamide molded cage.

3) The recommended dimensional tolerances of shaft shown above are applicable except h6.

4) The recommended dimensional tolerances of housing bore shown above are applicable except N7.

[Remark] Limiting speed of grease lubrication should be kept to under 60 % of that for oil lubrication.

# Drawn cup needle roller bearings

$F_w$  (40) ~ 45 mm

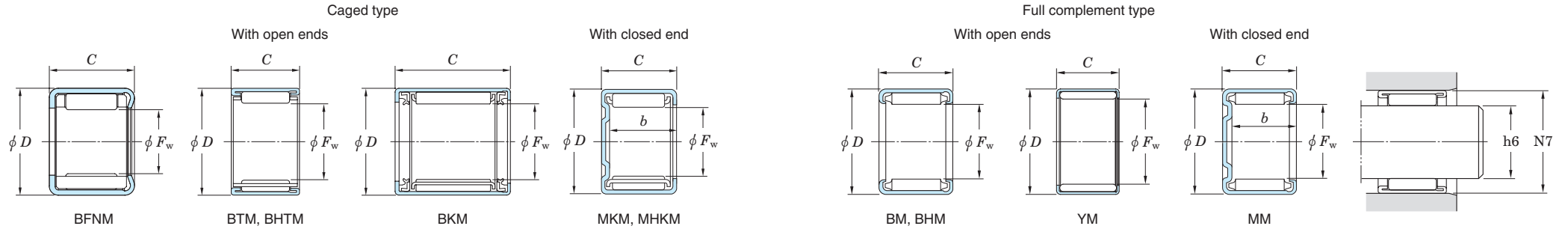

Boundary dimensions (mm)				Basic load ratings (kN)		Limiting speeds (min <sup>-1</sup> )	Bearing No. <sup>2)</sup>				Recommended dimensions (mm)				(Refer.) Mass (g)	
$F_w$	$D$	$C$	$b_{min.}$	$C_r$	$C_{0r}$	Oil lub.	Caged type		Full complement type		Shaft dia. (h6)		Housing bore dia. (N7)		With open ends	With closed end
							With open ends	With closed end	With open ends	With closed end	min.	max.	min.	max.		
40	47	16	—	23.8	60.5	3 300	—	—	40BM4716	—	39.984	40.000	46.967	46.992	43	—
	47	16	13.3	18.7	37.1	9 400	40BTM4716	40MKM4716	—	—	39.984	40.000	46.967	46.992	39	44
	47	20	17.2	30.3	82.6	3 300	—	—	40BM4720	40MM4720	39.984	40.000	46.967	46.992	56	63
	47	20	17.3	23.7	50.4	9 400	40BTM4720	40MKM4720	—	—	39.984	40.000	46.967	46.992	48	55
	50	15	—	23.4	45.2	3 200	—	—	BM4015-1	—	39.984	40.000	49.967	49.992	55	—
	50	15	—	20.2	31.2	9 100	BTM4015	—	—	—	39.984	40.000	49.967	49.992	54	—
	50	20	17.3	28.5	48.5	9 100	BTM4020	MKM4020	—	—	39.984	40.000	49.967	49.992	73	82
	50	25	—	36.2	66.2	9 100	BTM4025	—	—	—	39.984	40.000	49.967	49.992	91	—
	50	30	27.3	43.0	82.5	9 100	BTM4030-1	MKM4030	—	—	39.984	40.000	49.967	49.992	109	123
	50	40	—	54.8	113	9 100	BTM4040-OH	—	—	—	39.984	40.000	49.967	49.992	141	—
	51	20	—	40.2	84.7	3 200	—	—	YM405120J	—	39.984	40.000	50.961	50.991	96	—
	51	30	—	43.5	76.6	9 000	40BTM5130J	—	—	—	39.984	40.000	50.961	50.991	112	—
	53	20	—	46.7	87.3	3 100	—	—	YM405320JM	—	39.984	40.000	52.961	52.991	114	—
41.50	46.50	8.50	—	7.00	13.9	9 200	BTM424709AJ	—	—	—	41.484	41.500	46.467	46.492	15	—
42	53	30	—	45.7	83.9	8 600	BTM425330J	—	—	—	41.984	42.000	52.961	52.991	121	—
43	49	12	—	8.35	15.1	8 800	43BTM4912A	—	—	—	42.984	43.000	48.989 <sup>4)</sup>	49.014 <sup>4)</sup>	25	—
43.52	48.52	14	—	12.0	29.0	8 800	44BTM4914A	—	—	—	43.504	43.520	48.487	48.512	28	—
45	52	12	—	13.7	26.9	8 400	45BTM5212A	—	—	—	44.984	45.000	51.961	51.991	34	—
	52	16	—	23.8	65.9	2 900	—	—	45BM5216	—	44.984	45.000	51.961	51.991	49	—
	52	16	13.3	19.1	41.3	8 400	45BTM5216	45MKM5216	—	—	44.984	45.000	51.961	51.991	45	51
	52	20	17.2	30.4	90.1	2 900	—	—	45BM5220	45MM5220	44.984	45.000	51.961	51.991	62	71
	52	20	17.3	23.3	33.4	8 200	45BTM5220A	MKM4520	—	—	44.984	45.000	54.961	54.991	79	90
	52	30	27.3	45.3	91.7	8 200	BTM4530	MKM4530	—	—	44.984	45.000	54.961	54.991	120	136
	55	20	—	30.0	53.9	8 200	BTM4520A	—	—	—	44.984	45.000	54.961	54.991	79	—

[Notes] 1) The limiting speeds shown above are applicable when oil seal is used and the bearing is lubricated with grease.

2) FN in bearing number indicates a bearing comprising polyamide molded cage.

3) The recommended dimensional tolerances of shaft shown above are applicable except h6.

4) The recommended dimensional tolerances of housing bore shown above are applicable except N7.

[Remark] Limiting speed of grease lubrication should be kept to under 60 % of that for oil lubrication.

Drawn cup needle roller bearings

$F_w$  48 ~ 76.50 mm

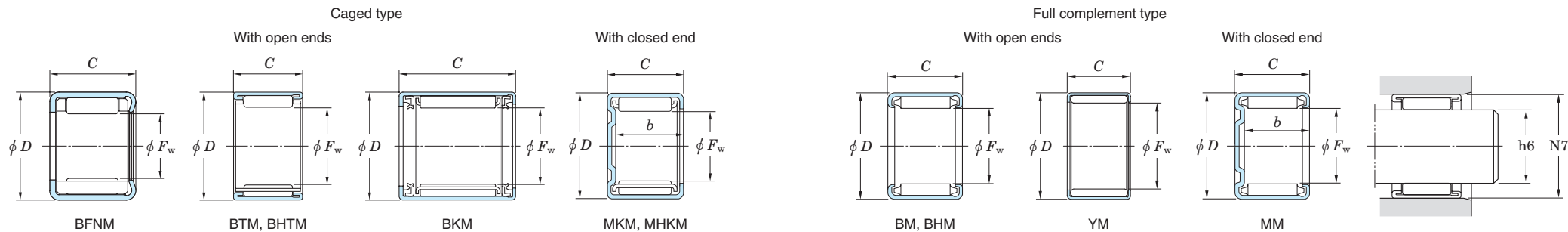

Boundary dimensions (mm)				Basic load ratings (kN)		Limiting speeds (min <sup>-1</sup> )	Bearing No. <sup>2)</sup>				Recommended dimensions (mm)				(Refer.) Mass (g)	
$F_w$	$D$	$C$	$b_{min.}$	$C_r$	$C_{0r}$	Oil lub.	Caged type		Full complement type		Shaft dia. (h6)		Housing bore dia. (N7)		With open ends	With closed end
							With open ends	With closed end	With open ends	With closed end	min.	max.	min.	max.		
<b>48</b>	56	30	—	41.0	100	7 800	<b>BTM485630J</b>	—	—	—	47.984	48.000	55.961	55.991	102	—
<b>50</b>	58	16	—	21.9	43.8	7 500	<b>BTM505816J</b>	—	—	—	49.984	50.000	57.961	57.991	54	—
	58	20	—	35.8	98.0	2 600	—	—	<b>50BM5820</b>	—	49.984	50.000	57.961	57.991	78	—
	58	20	17.3	28.4	61.0	7 500	<b>50BTM5820J</b>	<b>50MKM5820</b>	—	—	49.984	50.000	57.961	57.991	68	76
	58	25	—	45.2	133	2 600	—	—	<b>50BM5825</b>	—	49.984	50.000	57.961	57.991	98	—
	58	25	22.3	35.9	82.5	7 500	<b>50BTM5825</b>	<b>50MKM5825</b>	—	—	49.984	50.000	57.961	57.991	86	97
	62	15	—	24.3	36.4	7 300	<b>BTM5015</b>	—	—	—	49.984	50.000	61.961	61.991	73	—
	62	20	17.3	34.5	57.1	7 300	<b>BTM5020</b>	<b>MKM5020</b>	—	—	49.984	50.000	61.961	61.991	99	112
	62	25	—	43.9	77.8	7 300	<b>BTM5025</b>	—	—	—	49.984	50.000	61.961	61.991	125	—
	62	30	27.3	52.8	98.5	7 300	<b>BTM5030</b>	<b>MKM5030</b>	—	—	49.984	50.000	61.961	61.991	153	173
<b>55</b>	63	20	—	29.1	65.1	6 900	<b>55BTM6320</b>	—	—	—	54.981	55.000	62.961	62.991	73	—
	67	20	—	36.4	63.1	6 700	<b>55BTM6720A</b>	—	—	—	54.981	55.000	66.961	62.991	110	—
<b>64</b>	73.178	21.10	—	36.1	83.8	5 900	<b>64BTM7321A</b>	—	—	—	63.981	64.000	73.139	73.129	110	—
<b>66</b>	72	16	—	21.9	61.1	5 900	<b>BTM667216J</b>	—	—	—	65.981	66.000	71.961	71.991	54	—
<b>71.60</b>	78.60	15	—	22.9	61.9	5 400	<b>BTM727915AJ</b>	—	—	—	71.581	71.600	78.561	78.591	66	—
<b>76.50</b>	83.50	15	—	23.5	65.4	5 000	<b>BTM778415AJ</b>	—	—	—	76.481	76.500	83.455	83.490	70	—

[Notes] 1) The limiting speeds shown above are applicable when oil seal is used and the bearing is lubricated with grease.  
 2) FN in bearing number indicates a bearing comprising polyamide molded cage.  
 3) The recommended dimensional tolerances of shaft shown above are applicable except h6.  
 4) The recommended dimensional tolerances of housing bore shown above are applicable except N7.

[Remark] Limiting speed of grease lubrication should be kept to under 60 % of that for oil lubrication.

Machined ring needle roller bearings

$F_w$  12 ~ 17 mm

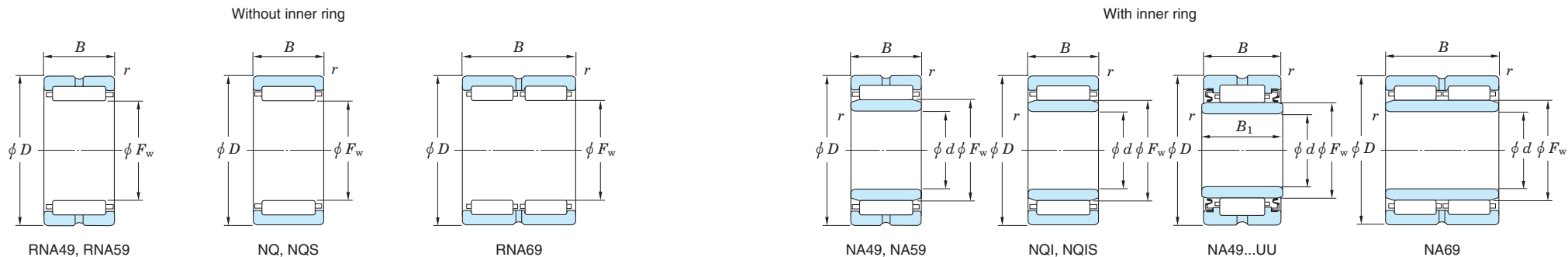

Boundary dimensions (mm)						Basic load ratings (kN)		Limiting speeds <sup>1)</sup> (min <sup>-1</sup> )	Bearing No.	Mounting dimensions (mm)			(Refer.) Mass (kg)		(Refer.) Applicable inner ring No.	
$F_w$	$d$	$D$	$B$	$B_1$	$r_{min.}$	$C_r$	$C_{0r}$	Oil lub.		Without inner ring	With inner ring	$d_a$ min.	$D_a$ max.	$r_a$ max.	Without inner ring	With inner ring
12	—	19	10	—	0.3	5.9	6.3	35 000	NQ12/10 12NQ2410A	—	—	17	0.3	0.010	—	—
	—	24	9.8	—	0.3	5.9	6.3	35 000		—	—	—	22	0.3	0.023	—
14	10	22	13	14	0.3	7.5	7.7	14 000	—	NA4900UU	12	20	0.3	—	0.025	IRM101414
	10	22	13	—	0.3	7.6	9.1	31 000	RNA4900	NA4900	12	20	0.3	0.017	0.025	IRM101413
	10	22	13	—	0.3	9.3	10.1	30 000	RNA4900R	NA4900R	12	20	0.3	0.016	0.023	IRM101413
	—	22	16	—	0.5	11.7	13.7	30 000	NQ14/16D	—	—	19	0.5	0.021	—	—
15	—	23	12	—	0.3	8.8	9.7	29 000	NQ15/12	—	—	21	0.3	0.017	—	—
	—	24	10	—	0.3	8.5	8.2	28 000	15NQ2410D	—	—	22	0.3	0.016	—	—
	—	25	12	—	0.6	10.5	10.8	28 000	NQ152512	—	—	21	0.6	0.022	—	—
	—	26	16	—	0.3	13.4	14.8	28 000	NQS15/16	—	—	24	0.3	0.034	—	—
—	28	15	—	1	7.9	9.8	28 000	15NQ2815	—	—	23	1	0.043	—	—	
16	—	23	16	—	0.5	13.1	16.4	27 000	16NQ2316	—	—	20	0.5	0.018	—	—
	—	23	16	—	0.5	15.2	17.4	28 000	NQ15/16B	—	—	20	0.5	0.020	—	—
	—	23	22	—	0.5	17.1	23.0	27 000	16NQ2322A	—	—	20	0.5	0.025	—	—
	—	24	12	—	0.3	7.7	9.6	28 000	NQ16/12	—	—	22	0.3	0.019	—	—
	12	24	13	14	0.3	8.3	9.2	12 000	—	NA4901UU	14	22	0.3	—	0.028	IRM121614
	12	24	13	—	0.3	8.6	11.1	28 000	RNA4901	NA4901	14	22	0.3	0.019	0.028	IRM121613
	12	24	13	—	0.3	10.2	11.8	27 000	RNA4901R	NA4901R	14	22	0.3	0.018	0.027	IRM121613
	—	24	16	—	0.3	10.9	15.2	28 000	NQ16/16D	—	—	22	0.3	0.025	—	—
	12	24	16	16	0.3	10.9	15.2	28 000	—	NQ112/16D	14	22	0.3	—	0.036	—
	—	24	20	—	0.3	13.1	19.1	28 000	NQ16/20	—	—	22	0.3	0.032	—	—
12	24	22	—	0.3	16.3	21.7	27 000	RNA6901	NA6901	14	22	0.3	0.030	0.045	IRM121622	
17	—	25	16	—	0.5	11.3	16.2	26 000	NQ17/16D	—	—	22	0.5	0.026	—	—
	—	25	20	—	0.3	13.7	20.6	26 000	17NQ2520	—	—	23	0.3	0.033	—	—
	—	30	13	—	0.3	10.0	10.5	25 000	17NQ3013D	—	—	28	0.3	0.041	—	—
	—	32	16	—	0.6	18.0	16.5	23 000	17NQ3216D	—	—	28	0.6	0.053	—	—

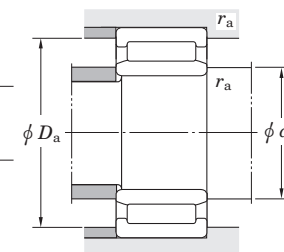

[Note] 1) Limiting speeds of bearing number NA49...UU indicates the value of sealed and grease lubricated bearings.  
 [Remark] Limiting speed of grease lubrication should be kept to under 60 % of that for oil lubrication.



Machined ring needle roller bearings

$F_w$  18 ~ (22) mm

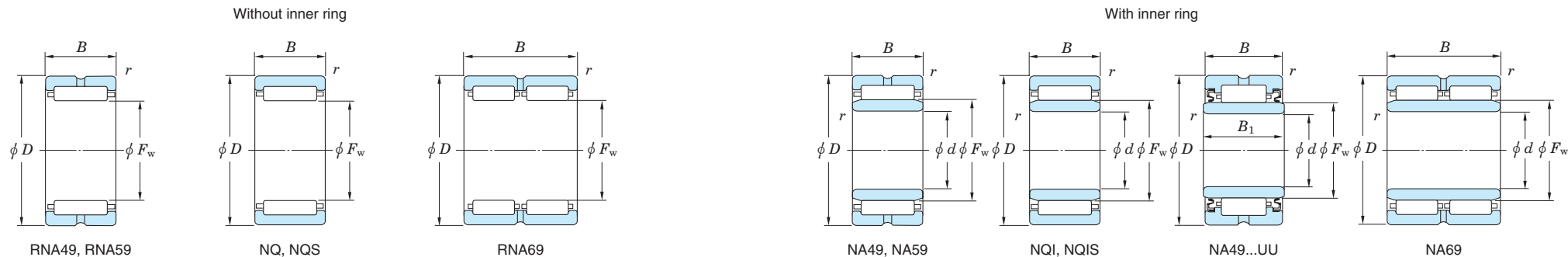

Boundary dimensions (mm)						Basic load ratings (kN)		Limiting speeds <sup>1)</sup> (min <sup>-1</sup> )	Bearing No.	Mounting dimensions (mm)			(Refer.) Mass (kg)		(Refer.) Applicable inner ring No.	
$F_w$	$d$	$D$	$B$	$B_1$	$r_{min.}$	$C_r$	$C_{0r}$	Oil lub.		Without inner ring	With inner ring	$d_a$ min.	$D_a$ max.	$r_a$ max.		Without inner ring
18	—	25	16	—	0.3	11.7	17.2	25 000	18NQ2516	—	—	23	0.3	0.023	—	—
	—	26	13	—	0.3	11.0	13.6	24 000	RNA49/14R	—	—	24	0.3	0.020	—	—
	—	26	16	—	0.3	11.7	17.2	25 000	NQ18/16	—	—	24	0.3	0.027	—	—
	—	26	20	—	0.3	14.1	21.7	25 000	NQ18/20	—	—	24	0.3	0.035	—	—
	—	28	19	—	0.3	16.9	20.9	24 000	18NQ2819	—	—	26	0.3	0.042	—	—
	12	30	16	—	0.3	13.7	14.3	23 000	NQS18/16	NQIS12/16	14	28	0.3	0.044	0.057	—
19	15	27	16	—	0.3	12.1	18.2	24 000	—	NQI15/16	17	25	0.3	0.042	—	—
20	—	27	17	—	0.3	14.7	20.4	22 000	20NQ2717	—	—	25	0.3	0.024	—	—
	15	28	13	14	0.3	9.2	11.1	10 000	—	NA4902UU	17	26	0.3	—	0.037	IRM152014
	15	28	13	—	0.3	9.2	12.8	23 000	RNA4902	NA4902	17	26	0.3	0.023	0.036	IRM152013
	15	28	13	—	0.3	11.3	14.6	22 000	RNA4902R	NA4902R	17	26	0.3	0.021	0.035	IRM152013
	—	28	16	—	0.3	12.0	18.2	23 000	NQ20/16D	—	—	26	0.3	0.030	—	—
	15	28	18	—	0.3	14.7	20.4	22 000	RNA5902	NA5902	17	26	0.3	0.029	0.048	IRM152018
	—	28	20	—	0.3	14.4	23.0	23 000	NQ20/20	—	—	26	0.3	0.038	—	—
	—	28	23	—	0.3	18.4	27.1	22 000	NQ202823	—	—	26	0.3	0.040	—	—
	—	30	20	—	0.3	19.8	26.4	22 000	20NQ3020	—	—	28	0.3	0.048	—	—
	—	32	12	—	0.3	11.9	11.3	21 000	20NQ3212	—	—	30	0.3	0.033	—	—
—	32	18	—	0.3	21.0	26.1	21 000	NQ203218	—	—	30	0.3	0.053	—	—	
21	—	33	15	—	0.6	14.0	16.9	21 000	20NQ3315D	—	—	29	0.6	0.052	—	—
	—	34	18	—	0.6	21.1	20.8	20 000	20NQ3418D	—	—	30	0.6	0.060	—	—
	—	38	17	—	0.6	21.1	21.1	19 000	21NQ3817	—	—	34	0.6	0.082	—	—
	22	17	30	13	14	0.3	9.4	11.8	9 100	—	NA4903UU	19	28	0.3	—	0.040
17		30	13	—	0.3	9.6	14.0	21 000	RNA4903D	NA4903	19	28	0.3	0.025	0.040	IRM172213
17		30	13	—	0.3	12.1	16.4	20 000	RNA4903R	NA4903R	19	28	0.3	0.023	0.038	IRM172213
—		30	16	—	0.3	12.7	20.2	21 000	NQ22/16	—	—	28	0.3	0.032	—	—
17		30	18	—	0.3	15.2	21.9	20 000	RNA5903	NA5903	19	28	0.3	0.031	0.052	IRM172218
—		30	20	—	0.3	15.3	25.6	21 000	NQ22/20	—	—	28	0.3	0.040	—	—

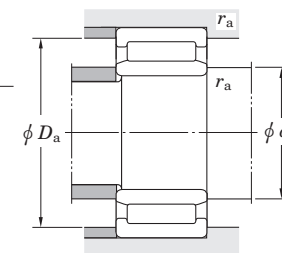

[Note] 1) Limiting speeds of bearing number NA49...UU indicates the value of sealed and grease lubricated bearings.  
 [Remark] Limiting speed of grease lubrication should be kept to under 60 % of that for oil lubrication.

Machined ring needle roller bearings

$F_w$  (22) ~ 28 mm

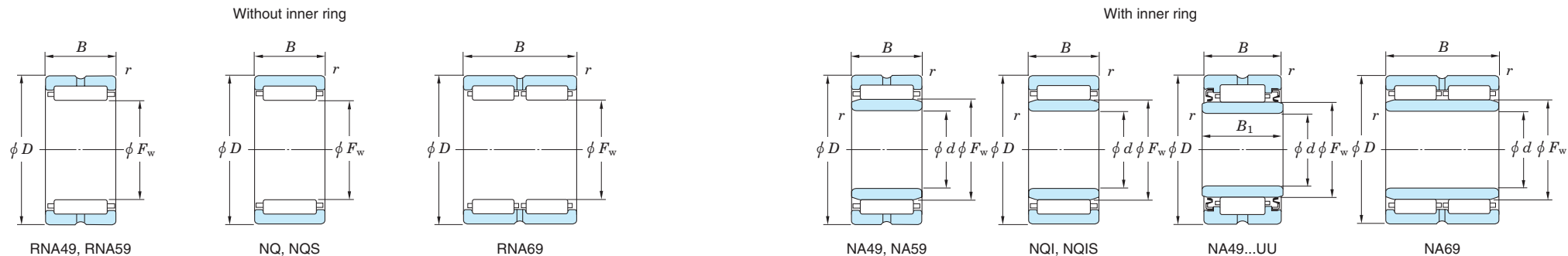

Boundary dimensions (mm)						Basic load ratings (kN)		Limiting speeds <sup>1)</sup> (min <sup>-1</sup> )	Bearing No.	Mounting dimensions (mm)			(Refer.) Mass (kg)		(Refer.) Applicable inner ring No.		
$F_w$	$d$	$D$	$B$	$B_1$	$r_{min.}$	$C_r$	$C_{0r}$	Oil lub.		Without inner ring	With inner ring	$d_a$ min.	$D_a$ max.	$r_a$ max.	Without inner ring	With inner ring	
22	17	30	23	—	0.3	18.9	29.0	20 000	RNA6903 22NQ3225	NA6903 —	19	28	0.3	0.040	0.067	IRM172223 —	
	—	32	25	—	0.3	22.4	31.7	20 000			—	—	30	0.3	0.063		—
24	20	32	12	—	0.3	9.6	14.4	19 000	NQ24/12 NQ24/16 NQ24/20AD —	NQI20/12 NQI20/16 — NQI203220AD	22	30	0.3	0.025	0.038	— — — 20IRM2420AD	
	—	32	16	—	0.3	13.4	22.2	19 000			—	—	30	0.3	0.035		0.052
	—	32	20	—	0.3	17.3	26.5	19 000			—	—	30	0.3	0.040		—
	20	32	20	20	0.3	17.3	26.5	19 000			—	—	30	0.3	—		0.062
25	—	33	16	—	0.3	14.1	20.6	18 000	NQ25/16 NQ25/20 — 25NQ3717AD-1 — RNA4904 RNA4904ARD-1 RNA5904 RNA6904	— — 20NQI3714 — NA4904UU NA4904 — NA5904 NA6904	—	31	0.3	0.034	—	— — — — IRM202518 IRM202517 — IRM202523 IRM202530	
	—	33	20	—	0.3	18.9	30.0	18 000			—	—	31	0.3	0.043		—
	20	37	14	—	0.3	17.1	19.1	17 000			—	—	35	0.3	—		0.066
	—	37	17	—	1	19.3	22.5	17 000			—	—	32	1	0.056		—
	20	37	17	18	0.3	16.4	18.2	8 000			—	—	35	0.3	—		0.078
	20	37	17	—	0.3	15.9	21.1	18 000			—	—	35	0.3	0.058		0.081
	—	37	17	—	0.9	21.5	25.7	17 000			—	—	32	0.9	0.054		—
	20	37	23	—	0.3	28.0	36.1	17 000			—	—	35	0.3	0.073		0.104
20	37	30	—	0.3	35.4	48.9	17 000	—	—	35	0.3	0.096	0.137				
26	22	34	16	—	0.3	14.1	24.2	18 000	NQ26/16 26NQ3420 26NQ4717 26NQ5214	NQI22/16 — — —	24	32	0.3	0.037	0.056	— — — —	
	—	34	20	—	0.3	14.2	28.9	18 000			—	—	32	0.3	0.042		—
	—	47	17	—	0.6	21.4	23.6	16 000			—	—	43	0.6	0.113		—
	—	52	14	—	0.6	18.0	18.9	16 000			—	—	48	0.6	0.136		—
28	—	37	20	—	0.3	20.6	34.7	16 000	NQ283720D NQ28/30 RNA49/22 RNA49/22R RNA69/22 28NQ4017 28NQ4020	— — NA49/22 — NA69/22 — —	—	35	0.3	0.056	—	— — IRM222817 — IRM222830 — —	
	—	37	30	—	0.3	29.1	54.1	16 000			—	—	35	0.3	0.083		—
	22	39	17	—	0.3	17.8	25.4	16 000			—	—	37	0.3	0.056		0.086
	—	39	17	—	0.3	21.8	29.8	16 000			—	—	37	0.3	0.055		—
	22	39	30	—	0.3	36.8	53.1	16 000			—	—	37	0.3	0.100		0.154
	—	40	17	—	0.3	15.1	27.4	16 000			—	—	38	0.3	0.068		—
	—	40	20	—	0.3	20.6	34.7	16 000			—	—	38	0.3	0.087		—

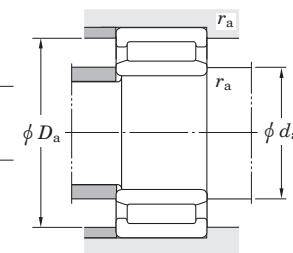

[Note] 1) Limiting speeds of bearing number NA49...UU indicates the value of sealed and grease lubricated bearings.  
 [Remark] Limiting speed of grease lubrication should be kept to under 60 % of that for oil lubrication.

Machined ring needle roller bearings

$F_w$  29 ~ 37 mm

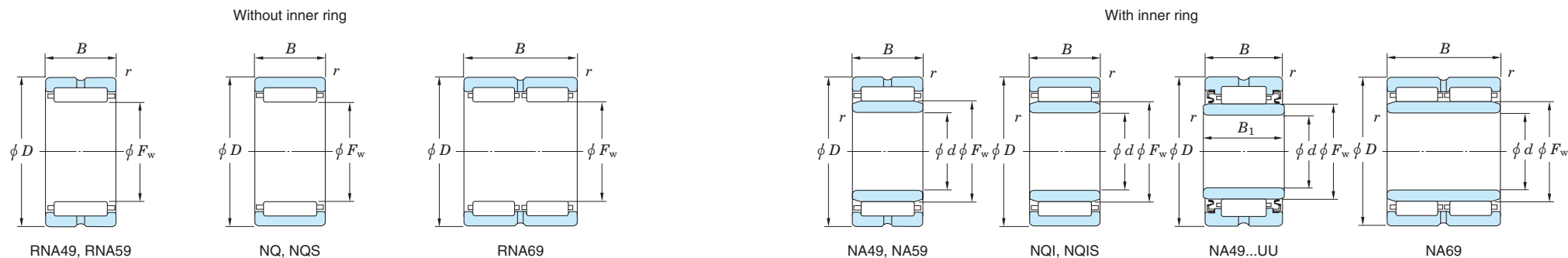

$F_w$	Boundary dimensions (mm)					Basic load ratings (kN)		Limiting speeds <sup>1)</sup> (min <sup>-1</sup> ) Oil lub.	Bearing No.	Mounting dimensions (mm)			(Refer.) Mass (kg)		(Refer.) Applicable inner ring No.	
	$d$	$D$	$B$	$B_1$	$r_{min.}$	$C_r$	$C_{0r}$			Without inner ring	With inner ring	$d_a$ min.	$D_a$ max.	$r_a$ max.		Without inner ring
29	25	38	15	—	0.6	14.6	22.6	16 000	—	NQI25/15	29	34	0.6	—	0.061	—
	—	38	20	—	0.6	20.4	34.8	16 000	NQ29/20	—	—	34	0.6	0.056	—	—
	25	38	30	—	0.3	28.9	54.3	16 000	NQ29/30	NQI25/30	27	36	0.3	0.085	0.125	—
30	—	40	20	—	0.3	23.7	37.5	15 000	NQ30/20	—	—	38	0.3	0.066	—	—
	—	40	30	—	0.3	33.5	58.5	15 000	NQ30/30	—	—	38	0.3	0.099	—	—
	25	42	17	18	0.3	18.4	22.4	6 600	—	NA4905UU	27	40	0.3	—	0.092	IRM253018
	25	42	17	—	0.3	18.6	27.4	15 000	RNA4905	NA4905	27	40	0.3	0.065	0.096	IRM253017
	25	42	17	—	0.3	24.2	31.7	15 000	RNA4905R	NA4905R	27	40	0.3	0.065	0.092	IRM253017
	25	42	23	—	0.3	31.7	44.9	15 000	RNA5905	NA5905	27	40	0.3	0.085	0.124	IRM253023
	—	42	30	—	0.6	40.1	60.7	15 000	NQ304230	—	—	38	0.6	0.116	—	—
	25	42	30	—	0.3	40.1	60.7	15 000	RNA6905	NA6905	27	40	0.3	0.112	0.162	IRM253030
	25	44	25	25.5	0.3	36.0	48.8	14 000	—	25NQI4425A	27	42	0.3	—	0.161	—
32	28	42	20	—	0.3	24.3	39.4	14 000	NQ32/20	NQI28/20	30	40	0.3	0.070	0.098	—
	28	42	30	—	0.3	34.4	61.6	14 000	NQ32/30	NQI28/30	30	40	0.3	0.104	0.141	—
	28	45	17	—	0.3	25.0	33.8	14 000	RNA49/28R	NA49/28R	30	43	0.3	0.075	0.099	IRM283217
	25	47	22	—	0.3	31.2	41.4	14 000	NQS32/22	NQIS25/22	27	45	0.3	0.123	0.167	—
35	—	45	14	—	0.6	16.9	29.0	13 000	NQ354514	—	—	41	0.6	0.055	—	—
	30	45	20	—	0.3	24.7	41.4	13 000	—	NQI30/20	32	43	0.3	—	0.108	—
	30	47	17	18	0.3	19.5	25.3	5 700	—	NA4906UU	32	45	0.3	—	0.105	IRM303518
	30	47	17	17	0.3	20.0	31.6	13 000	RNA4906D	NA4906D	32	45	0.3	0.081	0.114	IRM303517D
	30	47	17	—	0.3	26.4	34.4	13 000	RNA4906R	NA4906R	32	45	0.3	0.070	0.103	IRM303517
	30	47	23	—	0.3	33.8	51.0	13 000	RNA5906	NA5906	32	45	0.3	0.096	0.141	IRM303523
	—	47	30	—	0.3	42.7	69.0	13 000	RNA6906	—	—	45	0.3	0.131	—	—
	—	48	24	—	0.3	33.9	51.3	13 000	35NQ4824D	—	—	46	0.3	0.123	—	—
37	32	47	20	—	0.3	26.0	45.1	13 000	NQ37/20	NQI32/20	34	45	0.3	0.079	0.114	—
	—	47	20	—	0.3	26.0	45.1	13 000	NQ37/20D	—	—	45	0.3	0.079	—	—

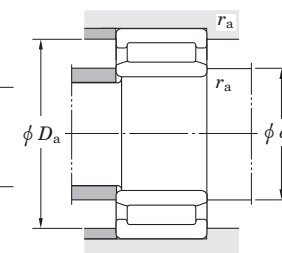

[Note] 1) Limiting speeds of bearing number NA49...UU indicates the value of sealed and grease lubricated bearings.  
 [Remark] Limiting speed of grease lubrication should be kept to under 60 % of that for oil lubrication.

Machined ring needle roller bearings

$F_w$  38 ~ 48 mm

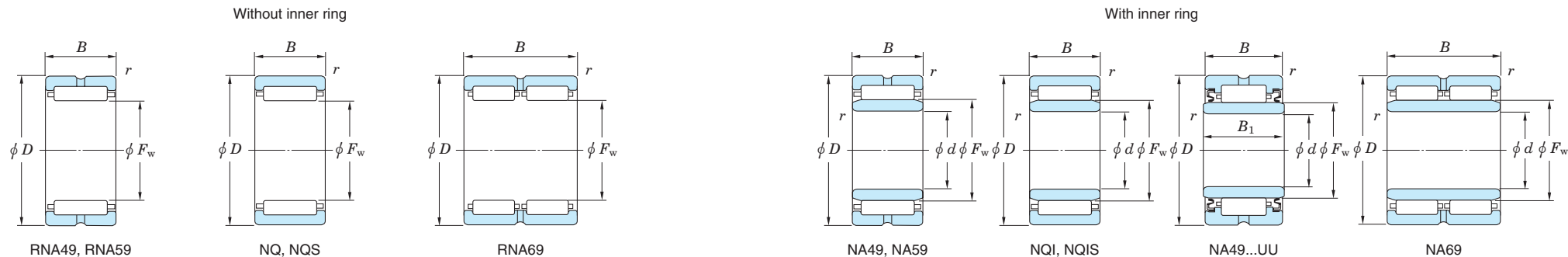

Boundary dimensions (mm)						Basic load ratings (kN)		Limiting speeds <sup>1)</sup> (min <sup>-1</sup> )	Bearing No.	Mounting dimensions (mm)			(Refer.) Mass (kg)		(Refer.) Applicable inner ring No.	
$F_w$	$d$	$D$	$B$	$B_1$	$r_{min.}$	$C_r$	$C_{0r}$	Oil lub.		Without inner ring	With inner ring	$d_a$ min.	$D_a$ max.	$r_a$ max.		Without inner ring
38	—	47	20	—	0.3	23.6	45.8	12 000	38NQ4720 38NQ5235	—	—	45	0.3	0.073	—	
	—	52	35	—	1	49.3	84.7	12 000		—	—	—	47	1	0.203	—
40	—	48	20	—	0.3	20.9	39.8	12 000	NQ404820 NQ40/15AD NQ40/20 NQ40/30 RNA49/32R-1 40NQ5230	—	—	—	46	0.3	0.064	—
	—	50	15	—	0.3	21.0	35.1	12 000		—	—	—	48	0.3	0.063	—
	35	50	20	—	0.3	27.2	48.8	12 000		NQI35/20	37	48	0.3	0.085	0.129	—
	35	50	30	—	0.3	39.8	79.8	12 000		NQI35/30	37	48	0.3	0.120	0.192	—
	—	52	20	—	0.6	31.9	49.3	11 000		—	—	—	48	0.6	0.098	—
	—	52	30	—	0.6	47.0	81.0	11 000		—	—	—	48	0.6	0.148	—
42	—	52	20	—	0.6	28.6	53.3	11 000	NQ425220D — RNA4907 RNA4907R RNA5907 RNA6907	—	—	—	48	0.6	0.087	—
	35	55	20	21	0.6	29.0	40.9	4 700		NA4907UU NA4907	39	51	0.6	—	0.173	IRM354221
	35	55	20	—	0.6	26.9	49.0	11 000		NA4907	39	51	0.6	0.122	0.186	IRM354220
	35	55	20	—	0.6	35.1	52.2	11 000		NA4907R	39	51	0.6	0.104	0.168	IRM354220
	35	55	27	—	0.6	42.9	67.6	11 000		NA5907	39	51	0.6	0.138	0.225	IRM354227
	35	55	36	—	0.6	51.4	85.1	11 000		NA6907	39	51	0.6	0.182	0.297	IRM354236
43	38	53	30	30	0.6	41.3	85.9	10 000	—	NQI38/30	—	51	0.6	—	0.205	—
45	—	55	20	—	0.6	27.9	52.7	10 000	NQ45/20 NQ45/30 RNA49/38R-1	—	—	—	51	0.6	0.100	—
	40	55	30	—	0.6	40.9	86.1	10 000		NQI40/30	44	51	0.6	0.138	0.214	—
	—	58	20	—	0.6	36.0	55.0	10 000		—	—	—	54	0.6	0.116	—
47	42	57	20	—	0.6	29.0	56.4	10 000	—	NQI42/20	46	53	0.6	—	0.143	—
	42	57	30	—	0.6	44.0	96.1	10 000	—	NQI42/30	46	53	0.6	—	0.219	—
48	40	62	22	23	0.6	35.7	51.7	4 100	— RNA4908 RNA4908R-2 RNA5908 RNA6908	NA4908UU NA4908	44	58	0.6	—	0.235	IRM404823
	40	62	22	—	0.6	32.6	58.5	9 700		NA4908	44	58	0.6	0.157	0.249	IRM404822
	—	62	22	—	0.6	43.2	66.1	9 400		—	—	—	58	0.6	0.142	—
	40	62	30	—	0.6	55.5	91.2	9 400		NA5908	44	58	0.6	0.187	0.313	IRM404830
	40	62	40	—	0.6	66.7	115.0	9 400		NA6908	44	58	0.6	0.256	0.415	IRM404840

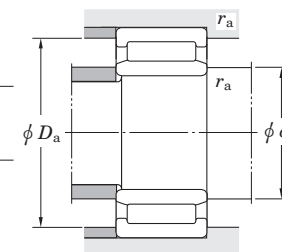

[Note] 1) Limiting speeds of bearing number NA49...UU indicates the value of sealed and grease lubricated bearings.  
 [Remark] Limiting speed of grease lubrication should be kept to under 60 % of that for oil lubrication.

Machined ring needle roller bearings

$F_w$  50 ~ 63 mm

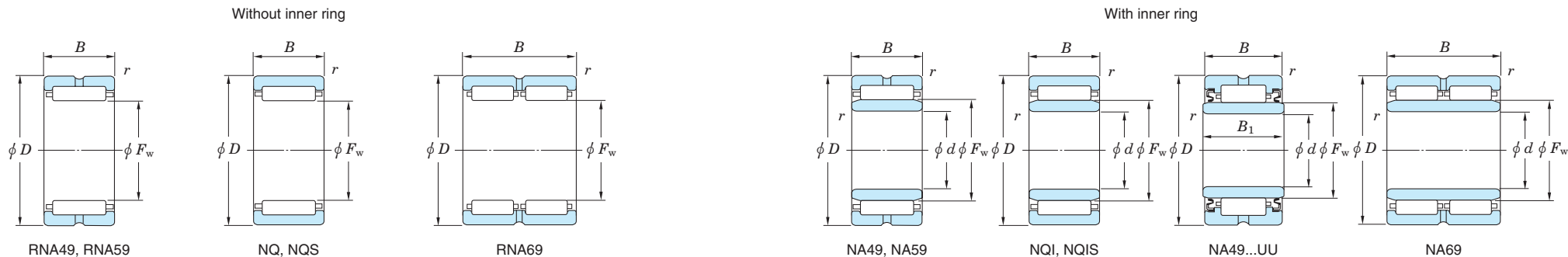

Boundary dimensions (mm)						Basic load ratings (kN)		Limiting speeds <sup>1)</sup> (min <sup>-1</sup> )	Bearing No.	Mounting dimensions (mm)			(Refer.) Mass (kg)		(Refer.) Applicable inner ring No.
$F_w$	$d$	$D$	$B$	$B_1$	$r_{min.}$	$C_r$	$C_{0r}$	Oil lub.		Without inner ring	With inner ring	$d_a$ min.	$D_a$ max.	$r_a$ max.	
50	—	62	20	—	0.6	24.8	46.0	9 400	<b>NQ50/20A</b>	—	—	58	0.6	0.126	—
	45	62	25	—	0.6	41.9	82.5	9 300	—	<b>NQI45/25</b>	49	58	0.6	—	0.223
	45	62	35	—	0.6	58.2	126.0	9 300	—	<b>NQI45/35</b>	49	58	0.6	—	0.316
	—	65	25	—	0.6	48.3	77.8	9 100	<b>NQ506525</b>	—	—	61	0.6	0.190	—
52	45	68	22	23	0.6	37.7	56.8	3 800	—	<b>NA4909UU</b>	49	64	0.6	—	0.285
	45	68	22	—	0.6	33.2	61.9	9 000	<b>RNA4909</b>	<b>NA4909</b>	49	64	0.6	0.205	0.294
	45	68	22	—	0.6	45.8	72.9	8 800	<b>RNA4909R</b>	<b>NA4909R</b>	49	64	0.6	0.185	0.274
	45	68	30	—	0.6	58.9	101.0	8 800	<b>RNA5909</b>	<b>NA5909</b>	49	64	0.6	0.252	0.365
	45	68	40	—	0.6	70.7	127.0	8 800	<b>RNA6909</b>	<b>NA6909</b>	49	64	0.6	0.334	0.496
53	—	68	24.5	—	0.6	47.1	81.7	8 700	<b>NQ536825A</b>	—	—	64	0.6	0.207	—
55	—	67	20	—	0.6	24.1	46.2	8 600	<b>55NQ6720A</b>	—	—	63	0.6	0.136	—
	50	68	25	—	0.6	47.4	90.4	8 500	—	<b>NQI50/25</b>	54	64	0.6	—	0.255
	—	70	22	—	0.6	46.9	76.5	8 300	<b>RNA49/48R</b>	—	—	66	0.6	0.174	—
	—	72	14	—	0.6	12.5	19.6	8 600	<b>55NQ7214</b>	—	—	68	0.6	0.149	—
	45	72	22	—	0.6	44.6	71.6	8 300	<b>NQS55/22</b>	<b>NQIS45/22</b>	49	68	0.6	0.210	0.341
58	50	72	22	—	0.6	35.7	70.6	8 100	<b>RNA4910</b>	<b>NA4910</b>	54	68	0.6	0.191	0.298
	50	72	22	—	0.6	48.0	80.0	7 900	<b>RNA4910R</b>	<b>NA4910R</b>	54	68	0.6	0.172	0.276
	50	72	30	—	0.6	61.6	110.0	7 900	<b>RNA5910</b>	<b>NA5910</b>	54	68	0.6	0.221	0.375
	50	72	40	—	0.6	74.0	140.0	7 900	<b>RNA6910</b>	<b>NA6910</b>	54	68	0.6	0.291	0.497
60	—	72	25	—	0.6	45.4	97.3	7 900	<b>NQ60/25</b>	—	—	68	0.6	0.164	—
	—	75	22	—	0.6	49.1	83.4	7 700	<b>RNA49/52R</b>	—	—	71	0.6	0.188	—
63	55	80	25	—	1	44.4	87.2	7 500	<b>RNA4911</b>	<b>NA4911</b>	60	75	1	0.287	0.428
	55	80	25	—	1	58.4	99.0	7 300	<b>RNA4911R</b>	<b>NA4911R</b>	60	75	1	0.260	0.401
	55	80	34	—	1	75.6	138.0	7 300	<b>RNA5911</b>	<b>NA5911</b>	60	75	1	0.354	0.546
	55	80	45	—	1	86.7	165.0	7 300	<b>RNA6911</b>	<b>NA6911</b>	60	75	1	0.458	0.711

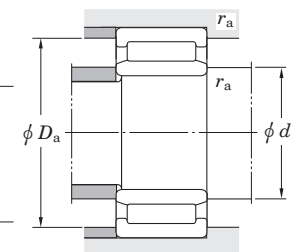

[Note] 1) Limiting speeds of bearing number NA49...UU indicates the value of sealed and grease lubricated bearings.  
 [Remark] Limiting speed of grease lubrication should be kept to under 60 % of that for oil lubrication.

Machined ring needle roller bearings

$F_w$  65 ~ 105 mm

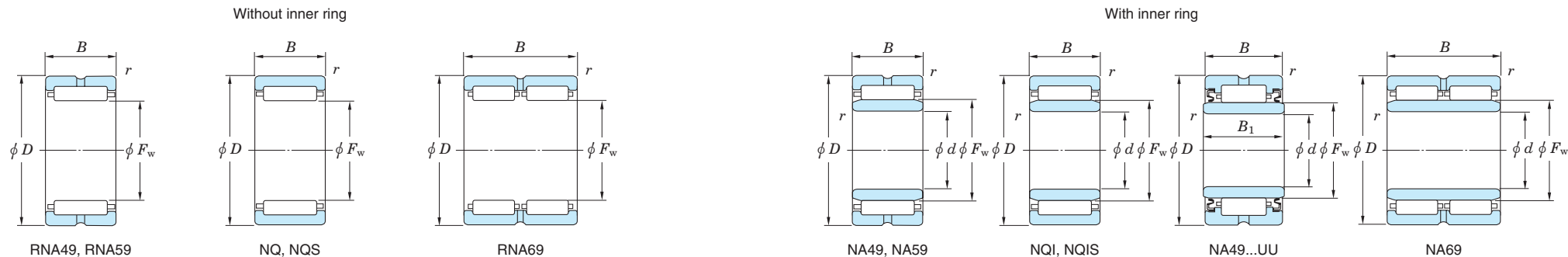

Boundary dimensions (mm)						Basic load ratings (kN)		Limiting speeds <sup>1)</sup> (min <sup>-1</sup> )	Bearing No.	Mounting dimensions (mm)			(Refer.) Mass (kg)		(Refer.) Applicable inner ring No.	
$F_w$	$d$	$D$	$B$	$B_1$	$r_{min.}$	$C_r$	$C_{0r}$	Oil lub.		Without inner ring	With inner ring	$d_a$ min.	$D_a$ max.	$r_a$ max.		Without inner ring
65	—	82	25	—	1	59.9	103.0	7 100	RNA49/58R	—	—	77	1	0.277	—	—
68	60	85	25	—	1	45.8	93.3	6 900	RNA4912	NA4912	65	80	1	0.310	0.459	IRM606825
	60	85	34	—	1	79.2	150.0	6 800	RNA5912	NA5912	65	80	1	0.380	0.587	IRM606834
70	—	88	25	—	1	64.5	109.0	6 600	RNA49/62	—	—	83	1	0.298	—	—
72	65	90	25	—	1	66.1	114.0	6 400	RNA4913	NA4913	70	85	1	0.307	0.450	IRM657225
	65	90	34	—	1	85.4	158.0	6 400	RNA5913	NA5913	70	85	1	0.419	0.613	IRM657234
	65	90	45	—	1	98.4	190.0	6 400	RNA6913	NA6913	70	85	1	0.541	0.798	IRM657245
75	—	95	30	—	1	82.3	145.0	6 100	RNA49/68	—	—	90	1	0.437	—	—
80	70	100	30	—	1	86.4	157.0	5 700	RNA4914	NA4914	75	95	1	0.483	0.733	IRM708030
	70	100	40	—	1	107.0	207.0	5 700	RNA5914	NA5914	75	95	1	0.615	0.973	IRM708040
	70	100	54	—	1	132.0	271.0	5 700	RNA6914	NA6914	75	95	1	0.895	1.37	IRM708054
85	75	105	30	—	1	88.0	164.0	5 400	RNA4915	NA4915	80	100	1	0.507	0.773	IRM758530
	75	105	40	—	1	109.0	216.0	5 400	RNA5915	NA5915	80	100	1	0.644	1.03	IRM758540
	75	105	54	—	1	135.0	283.0	5 400	RNA6915	NA6915	80	100	1	0.866	1.44	IRM758554
90	80	110	30	—	1	91.6	176.0	5 100	RNA4916	NA4916	85	105	1	0.540	0.819	IRM809030
	80	110	40	—	1	114.0	232.0	5 100	RNA5916	NA5916	85	105	1	0.681	1.09	IRM809040
	80	110	54	—	1	140.0	304.0	5 100	RNA6916	NA6916	85	105	1	0.916	1.46	IRM809054
95	—	115	30	—	1.1	92.8	183.0	4 900	RNA49/82	—	—	108.5	1	0.537	—	—
100	85	120	35	—	1.1	110.0	230.0	4 600	RNA4917	NA4917	91.5	113.5	1	0.669	1.25	IRM8510035
	85	120	46	—	1.1	126.0	293.0	4 700	RNA5917	NA5917	91.5	113.5	1	0.952	1.65	IRM8510046
	85	120	63	—	1.1	165.0	390.0	4 600	RNA6917	NA6917	91.5	113.5	1	1.17	2.29	IRM8510063
105	90	125	35	—	1.1	111.0	238.0	4 400	RNA4918	NA4918	96.5	118.5	1	0.695	1.31	IRM9010535
	90	125	46	—	1.1	137.0	311.0	4 400	RNA5918	NA5918	96.5	118.5	1	0.898	1.70	IRM9010546
	90	125	63	—	1.1	167.0	403.0	4 400	RNA6918	NA6918	96.5	118.5	1	1.21	2.31	IRM9010563

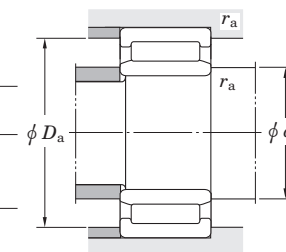

[Note] 1) Limiting speeds of bearing number NA49...UU indicates the value of sealed and grease lubricated bearings.  
 [Remark] Limiting speed of grease lubrication should be kept to under 60 % of that for oil lubrication.

# Machined ring needle roller bearings

$F_w$  110 ~ 160 mm

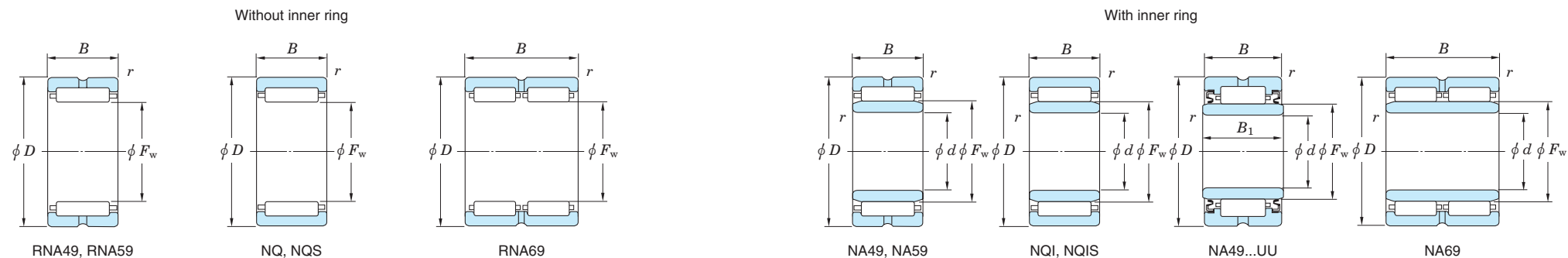

Boundary dimensions (mm)						Basic load ratings (kN)		Limiting speeds <sup>1)</sup> (min <sup>-1</sup> )	Bearing No.	Mounting dimensions (mm)			(Refer.) Mass (kg)		(Refer.) Applicable inner ring No.	
$F_w$	$d$	$D$	$B$	$B_1$	$r_{min.}$	$C_r$	$C_{or}$	Oil lub.		Without inner ring	With inner ring	$d_a$ min.	$D_a$ max.	$r_a$ max.		Without inner ring
<b>110</b>	95	130	35	—	1.1	115.0	253.0	4 200	<b>RNA4919</b>	<b>NA4919</b>	101.5	123.5	1	0.728	1.37	IRM9511035
	95	130	46	—	1.1	141.0	331.0	4 200	<b>RNA5919</b>	<b>NA5919</b>	101.5	123.5	1	0.940	1.78	IRM9511046
	95	130	63	—	1.1	173.0	428.0	4 200	<b>RNA6919</b>	<b>NA6919</b>	101.5	123.5	1	1.27	2.43	IRM9511063
<b>115</b>	100	140	40	—	1.1	144.0	296.0	4 000	<b>RNA4920</b>	<b>NA4920</b>	106.5	133.5	1	1.160	1.86	IRM10011540
	100	140	54	—	1.1	189.0	418.0	4 000	<b>RNA5920</b>	<b>NA5920</b>	106.5	133.5	1	1.49	2.53	IRM10011554
<b>125</b>	110	150	40	—	1.1	149.0	317.0	3 700	<b>RNA4922</b>	<b>NA4922</b>	116.5	143.5	1	1.17	2.01	IRM11012540
	110	150	54	—	1.1	195.0	448.0	3 700	<b>RNA5922</b>	<b>NA5922</b>	116.5	143.5	1	1.690	2.74	IRM11012554
<b>135</b>	120	165	45	—	1.1	192.0	398.0	3 400	<b>RNA4924</b>	<b>NA4924</b>	126.5	158.5	1	1.75	2.78	IRM12013545
	120	165	60	—	1.1	244.0	564.0	3 400	<b>RNA5924</b>	<b>NA5924</b>	126.5	158.5	1	2.43	3.80	IRM12013560
<b>150</b>	130	180	50	—	1.5	225.0	508.0	3 000	<b>RNA4926</b>	<b>NA4926</b>	138	172	1.5	2.21	3.83	IRM13015050
	130	180	67	—	1.5	274.0	655.0	3 000	<b>RNA5926</b>	<b>NA5926</b>	138	172	1.5	3.000	5.09	IRM13015067
<b>160</b>	140	190	50	—	1.5	232.0	540.0	2 800	<b>RNA4928</b>	<b>NA4928</b>	148	182	1.5	2.350	4.08	IRM14016050
	140	190	67	—	1.5	283.0	696.0	2 800	<b>RNA5928</b>	<b>NA5928</b>	148	182	1.5	3.02	5.42	IRM14016067

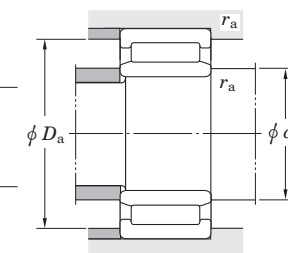

[Note] 1) Limiting speeds of bearing number NA49...UU indicates the value of sealed and grease lubricated bearings.  
 [Remark] Limiting speed of grease lubrication should be kept to under 60 % of that for oil lubrication.

# Needle roller thrust bearings

$d (d_1)$  10 ~ 22.2 mm

Separable type

Non-separable type

Needle roller and cage thrust assembly

Race

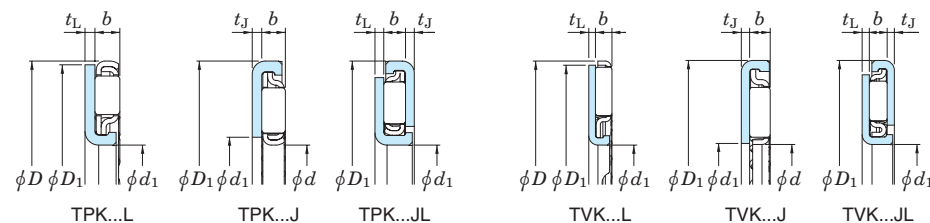
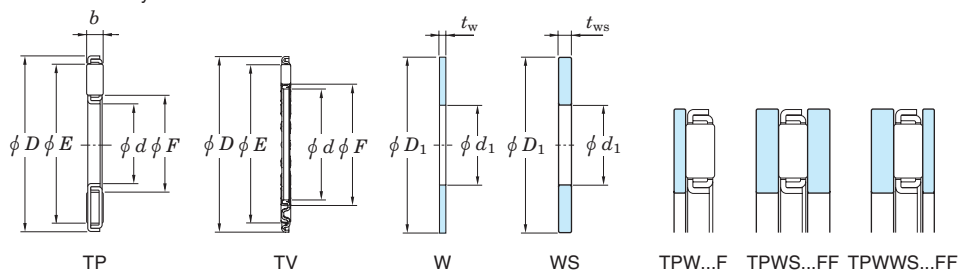

Boundary dimensions (mm)									Basic load ratings (kN)		Limiting speeds (min <sup>-1</sup> )	Bearing No.			Dimensions (mm)		(Refer.) Mass (g)				
$d$	$d_1$	$D$	$D_1$	$b$	$t_w$	$t_J$	$t_{ws}$	$t_L$	$C_a$	$C_{0a}$	Oil lub.	Needle roller and cage thrust ass'y Separable type	Thin plate race (pressed)	Thick plate race (machined)	$E$	$F$	TP TV	TPK TVK	(W)	(WS)	
10	10	24	24	2	1.0	—	2	—	6.35	18.3	12 000	TP1024-1	—	W1024F	WS1024F	15.2	21.8	3.5	—	2.9	5.8
	—	23	—	2	—	—	—	—	8	24	12 000	TV1023	—	—	—	12.6	21.8	2.5	—	—	—
12	—	24	—	2	—	—	—	—	3.75	9	12 000	TP1224	—	—	—	14.1	22.1	3.0	—	—	—
	12	25.8	26	2	1.0	—	2	—	6.55	19.79	11 000	TP1226B	—	W1226F	WS1226F	17.3	23.5	3.6	—	3.3	6.6
	12	26	26	2	1.0	—	2	—	8.6	27.5	11 000	TV1226	—	W1226F	WS1226BF	14.6	23.8	3.8	—	3.3	6.6
14	14	27	27	2	1	—	2.75	—	6.55	19.8	11 000	TP1427	—	W1427F	WS1427F	24.5	16.5	3.6	—	3.2	9.0
15	15	32.3	32	2	1.0	—	—	—	11	42.1	10 000	TP1532-1	—	W1532F	—	22.3	30.3	6.1	—	4.6	—
	15	28	28	2	1.0	—	2	—	9.85	34.3	11 000	TV1528	—	W1528F	WS1528F	17.6	26.8	4.1	—	3.4	6.8
16	16	29	29	2	1.5	—	2.75	—	9.15	31.4	11 000	TP1629	—	W1629AF	WS1629F	26.5	18.5	4.4	—	5.4	9.9
17	17	30	30	2	0.8	—	2.75	—	9.40	32.9	10 000	TP1730	—	W1730F	WS1730F	27.5	19.5	4.4	—	3.0	10
	17	40	40	2.5	—	—	3	—	17.9	69.3	8 000	TP1740	—	—	WS1740F	36.5	22.7	11	—	—	24
	17	34	34	2.5	—	—	2.155	—	14.1	49.5	8 700	TV1734	—	—	WS1734-2F	21.1	32.5	8.2	—	—	11
18	18	31	31	2	1.0	—	2	—	9.65	34.4	10 200	TP1831	—	W1831F	WS1831F	20.4	28.4	5.0	—	3.9	7.8
—	18.1	31.6	31	2	—	—	—	0.8	7.45	25.2	10 000	—	TPK1832L	—	—	22.8	29.4	—	8	—	—
—	18.75	—	39.7	1.984	—	0.8	—	0.8	9.8	37.4	9 000	—	TVK1940JL	—	—	25	34.2	—	17	—	—
19.6	21	—	35.9	2	—	0.8	—	—	6	18.7	9 400	—	TPK2036J-1	—	—	21.8	28	—	10	—	—
20	20	35	35	2	1	—	2.75	—	13.2	53.6	9 600	TP2035-1	—	W2035F	WS2035F	32.5	22.9	5.9	—	5.1	14
20.9	—	32	—	2	—	—	—	—	8.4	29.7	10 000	TP2132D	—	—	—	23.5	29.7	4.6	—	—	—
21.9	—	34	—	2	—	—	—	—	8.05	28.6	9 700	TP2234	—	—	—	25	31.2	5.1	—	—	—
22	22	37	37	2	1	—	2.75	—	12.6	51.7	9 300	TP2237-1	—	W2237F	WS2237F	34.5	22.9	6.4	—	5.4	15
—	22	41	41	2	—	—	—	0.8	13.2	56.8	8 800	—	TPK2241L	—	—	28	38	—	15	—	—
22.2	—	36.1	—	1.984	—	—	—	—	9.95	38.2	9 500	TP2236A-1	—	—	—	25.3	33.3	6.1	—	—	—



# Needle roller thrust bearings

$d (d_1)$  22.7 ~ 32.9 mm

Separable type

Non-separable type

Needle roller and cage thrust assembly

Race

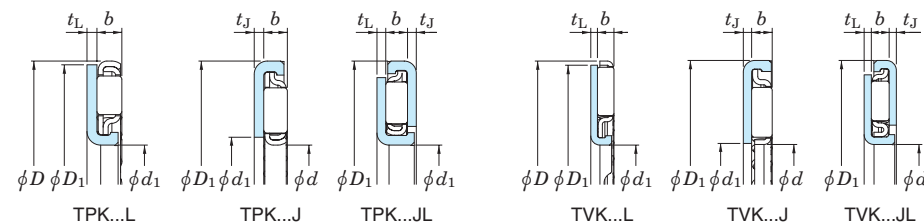
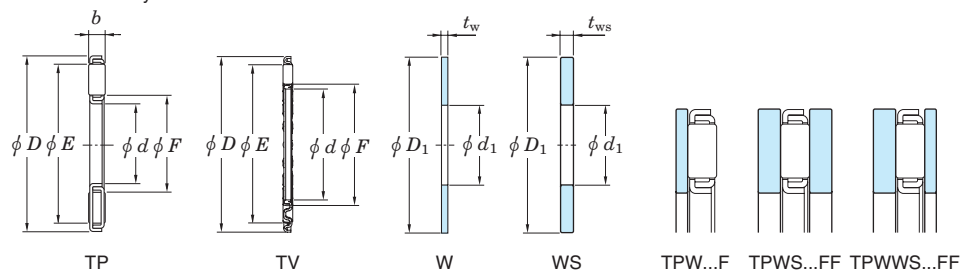

Boundary dimensions (mm)									Basic load ratings (kN)		Limiting speeds (min <sup>-1</sup> )	Bearing No.			Dimensions (mm)		(Refer.) Mass (g)				
$d$	$d_1$	$D$	$D_1$	$b$	$t_w$	$t_J$	$t_{ws}$	$t_L$	$C_a$	$C_{0a}$	Oil lub.	Needle roller and cage thrust ass'y Separable type	Thin plate race (pressed)	Thick plate race (machined)	$E$	$F$	( TP TV )	( TPK TVK )	(W)	(WS)	
22.7	22	—	35.1	2	—	0.8	—	—	8.3	29.7	9 500	—	TPK2235J	—	—	25	31.2	—	9.1	—	—
22.8	22	—	37.95	1.984	—	0.8	—	—	10.6	40.9	9 200	—	TVK2238J	—	—	24	33.2	—	11	—	—
25	25	42	42	2	1.0	—	3	—	14.8	66.2	8 700	TP2542	—	W2542F	WS2542KF	28.6	39.2	8.6	—	7	21
	25	—	39.5	2.5	—	0.8	—	—	14	51.5	8 100	—	TVK2540J	—	—	26.2	35.4	—	12.4	—	—
25.8	26	—	42	1.984	—	0.8	—	—	12.8	54.4	8 800	—	TVK2642J	—	—	27	37	—	13	—	—
26	—	38.66	—	2	—	—	—	—	10.4	41.2	9 100	TV2639-1	—	—	—	28.2	37.4	5.5	—	—	—
—	26	—	43.4	1.984	—	0.8	—	0.8	11.5	49	8 600	—	TPK2643JL	—	—	30.6	38.6	—	19	—	—
28	—	41	—	2	—	—	—	—	9.4	37.4	8 800	TP2841C	—	—	—	31.5	37.7	6.7	—	—	—
	28	45	45	2	0.8	—	3	—	15.1	70.3	8 400	TP2845	—	W2845F	WS2845F	42.5	31.9	9.0	—	6.1	19
	28	—	42.6	2	—	0.8	—	—	9.4	37.4	8 700	—	TPK2843AJ	—	—	31.5	37.7	—	13	—	—
28.5	28.5	46.15	46.15	2	0.8	—	—	—	12.1	52.4	8 300	TP2946A	—	W2946AF	—	32.4	40.4	9.3	—	6.5	—
28.9	—	42	—	1.984	—	—	—	—	11.7	50.4	8 800	TP2942A-1	—	—	—	31.6	39.6	7.2	—	—	—
—	29	47.21	47	2	—	—	—	1	15.9	76	8 300	—	TVK2947L	—	—	34	45	—	18	—	—
—	29	48.4	49	3	—	—	—	0.8	21.8	87.4	6 600	—	TVK2949L	—	—	35	47	—	22	—	—
30	30	47	47	2	1.0	—	2	—	16.2	78.6	8 300	TP3047-1	—	W3047F	WS3047F	34	44.6	10	—	8.1	16.2
—	30.1	45.5	45.5	1.984	—	—	—	0.8	12.4	55.9	8 400	—	TPK3046L	—	—	35	42.6	—	14	—	—
—	30.1	—	47.3	1.984	—	0.8	—	0.8	12.4	55.9	8 300	—	TPK3047JL-1	—	—	35	42.6	—	21	—	—
—	30.7	—	46.02	1.984	—	0.8	—	0.8	12.5	56.2	8 400	—	TPK3146JL-4	—	—	34.5	42.3	—	19	—	—
—	30.7	—	46.43	1.984	—	1	—	0.8	12.5	56.2	8 300	—	TPK3146JL-5	—	—	34.5	42.3	—	21	—	—
—	31.85	45.1	45.2	1.984	—	—	—	0.8	12.1	54.7	8 400	—	TVK3245L	—	—	36.2	44.2	—	12	—	—
32	32	49	49	2	1	—	3	—	17.3	86.2	8 100	TP3249	—	W3249F	WS3249F	46.5	35.9	10	—	8.5	25
—	32.9	53.1	53.1	1.984	—	—	—	0.8	18.4	97.2	7 800	—	TVK3353L	—	—	39.8	51.8	—	20	—	—

# Needle roller thrust bearings

$d (d_1)$  33.5 ~ 45 mm

Separable type

Non-separable type

Needle roller and cage thrust assembly

Race

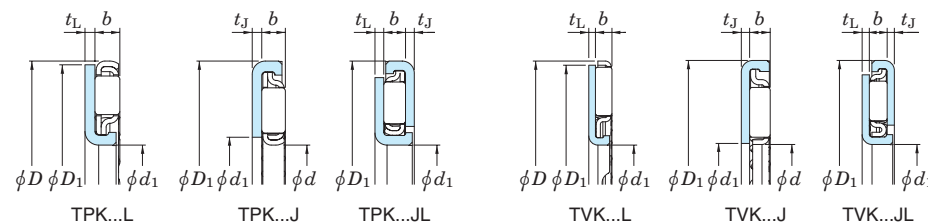
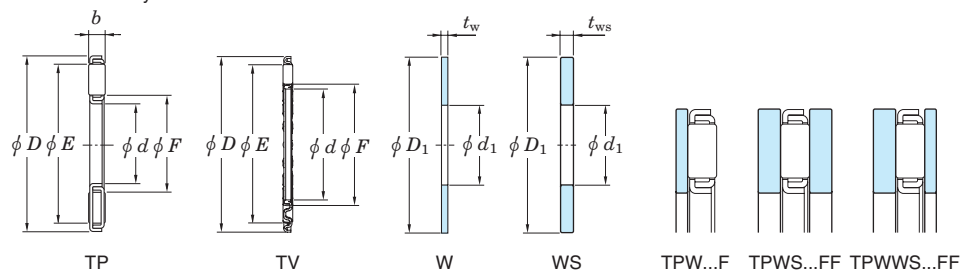

Boundary dimensions (mm)									Basic load ratings (kN)		Limiting speeds (min <sup>-1</sup> )	Bearing No.			Dimensions (mm)		(Refer.) Mass (g)				
$d$	$d_1$	$D$	$D_1$	$b$	$t_w$	$t_J$	$t_{ws}$	$t_L$	$C_a$	$C_{0a}$	Oil lub.	Needle roller and cage thrust ass'y Separable type	Thin plate race (pressed)	Thick plate race (machined)	$E$	$F$	$\left[ \begin{smallmatrix} TP \\ TV \end{smallmatrix} \right]$	$\left[ \begin{smallmatrix} TPK \\ TVK \end{smallmatrix} \right]$	(W)	(WS)	
33.5	—	45	—	2	—	—	—	—	8.5	34.3	8 400	<b>TP3445A</b>	—	—	37	42.6	6.8	—	—	—	
33.7	33.8	—	48.2	1.984	—	0.8	—	—	13.6	63	8 200	—	<b>TVK3448J-1</b>	—	—	35	44.2	—	14	—	—
—	34	—	51.4	2	—	0.8	—	0.8	12.6	58.1	7 900	—	<b>TPK3451JL</b>	—	—	38.6	46.6	—	23	—	—
34.65	35	52	52	2	1.0	—	3	—	17.1	86.9	7 800	<b>TP3552B</b>	—	<b>W3552F</b>	<b>WS3552AF</b>	38.4	49	11	—	9.1	27
—	34.6	58.4	58.2	2	0.8	—	—	—	20.5	114	7 400	<b>TP3558</b>	—	<b>W3558F</b>	—	44	56	16	—	11	—
—	34.6	58.4	58.2	2	0.8	—	—	—	22.4	128	7 400	<b>TP3558-1</b>	—	<b>W3558F</b>	—	42	56	16	—	11	—
—	37.4	57.3	57.3	1.984	—	—	—	0.8	19.3	106	7 500	—	<b>TVK3757L</b>	—	—	44	56	—	23	—	—
—	38	—	53	2	—	0.8	—	0.8	11.6	53.8	7 800	—	<b>TPK3853JL</b>	—	—	42.4	49	—	22	—	—
—	38	—	58	3	—	0.8	—	1	24.9	91.5	6 100	—	<b>TPK3858JL</b>	—	—	43.2	53.2	—	41	—	—
38.07	38	—	52	2	—	0.8	—	—	12	55.2	7 800	—	<b>TVK3852J-1</b>	—	—	39.8	47.8	—	15	—	—
38.15	38.15	55.29	55.29	1.984	0.8	—	3.0	—	19.9	108	7 600	<b>TP3855A</b>	—	<b>W3855F</b>	<b>WS3855F</b>	40.59	52.59	13	—	13	49
39.6	—	58.1	—	3	—	—	—	—	25.8	115	6 100	<b>TP4058-1</b>	—	—	—	43.3	55.3	22	—	—	—
40	40	60	60	3	1.0	—	2	—	23.5	103	6 000	<b>TP4060</b>	—	<b>W4060F</b>	<b>WS4060F</b>	44.4	56	23	—	12	24
41	—	68	—	9	—	—	—	—	75.8	222	3 200	<b>TP4168</b>	—	—	—	45.4	63.8	104	—	—	—
42	—	62	—	3	—	—	—	—	17.5	71.4	5 900	<b>TP4262</b>	—	—	—	47.8	56.4	23	—	—	—
—	42.5	—	61.2	1.984	—	0.8	—	0.8	15.5	81.7	7 300	—	<b>TVK4361JL-2</b>	—	—	47.6	56.8	—	29	—	—
—	43.45	—	61.2	1.984	—	0.8	—	0.8	14.6	74.9	7 300	—	<b>TVK4361JL</b>	—	—	47.6	56.8	—	29	—	—
—	43.45	—	61.74	1.984	—	1.1	—	0.8	14.6	74.9	7 200	—	<b>TVK4362JL</b>	—	—	47.6	56.8	—	32	—	—
45	45.24	62.19	62.2	1.984	0.8	—	2	—	20.3	115	7 200	<b>TV4562</b>	—	<b>W4562F</b>	<b>WS4562AF</b>	46.2	58.6	14	—	8.8	22
—	45	56	56	2	1.0	—	2	—	9	39.6	7 600	<b>TP4556</b>	—	<b>W4556F</b>	<b>WS4556F</b>	47.5	53.7	8.4	—	6.8	13.6
—	45	65	65	3	1.5	—	2	—	25.2	116	5 700	<b>TP4565A</b>	—	<b>W4565AF</b>	<b>WS4565F</b>	49.4	61	26	—	20	27

# Needle roller thrust bearings

$d (d_1)$  46.4 ~ 70.03 mm

Separable type

Non-separable type

Needle roller and cage thrust assembly

Race

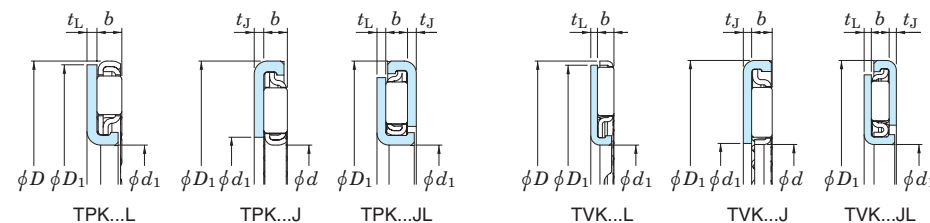
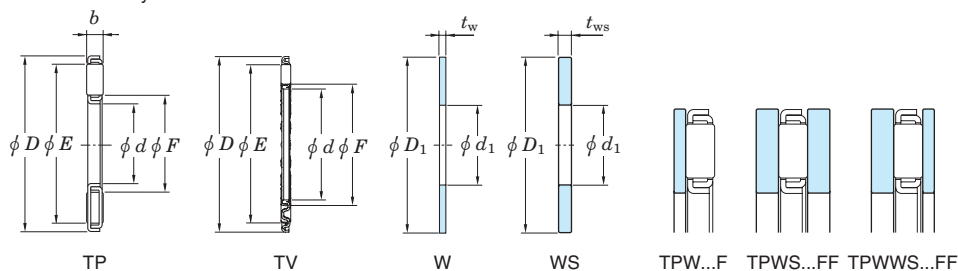

Boundary dimensions (mm)									Basic load ratings (kN)		Limiting speeds (min <sup>-1</sup> )	Bearing No.			Dimensions (mm)		(Refer.) Mass (g)			
$d$	$d_1$	$D$	$D_1$	$b$	$t_w$	$t_J$	$t_{ws}$	$t_L$	$C_a$	$C_{0a}$	Oil lub.	Needle roller and cage thrust ass'y Separable type	Thin plate race (pressed)	Thick plate race (machined)	$E$	$F$	[ TP TV ]	[ TPK TVK ]	(W)	(WS)
46.4	—	68	—	3.5	—	—	—	—	38.4	182	5 200	TP4668-2	—	—	49.4	65	35	—	—	—
—	48.25	—	72	3	—	0.8	—	0.8	30.9	129	5 400	—	TVK4872JL	—	—	54	66	—	56	—
49	49.1	70.65	71	1.984	0.8	—	1.84	—	18	105	6 800	TV4971	—	W4971AF WS4971F-1	58.4	68.4	17	—	13	30
50	50	70	70	3	1.0	—	2	—	26.7	129	5 500	TP5070	—	W5070F WS5070F	54.4	66	28	—	15	30
52	—	72.6	—	1.984	—	—	—	—	26	169	6 700	TV5273	—	—	56	71.2	19	—	—	—
—	53.6	—	69.6	1.984	—	0.8	—	0.8	15.9	89.3	6 800	—	TPK5470JL-3	—	—	57.4	65.2	—	32	—
—	53.6	—	70.18	1.984	—	1.1	—	0.8	15.9	89.3	6 800	—	TPK5470JL-4	—	—	57.4	65.2	—	36	—
55	55	78	78	3	1	—	4	—	32.4	171	5 200	TP5578	—	W5578F WS5578F	60.4	74	33	—	19	75
55.48	56.8	—	69.6	1.984	—	0.8	—	—	15.9	89.3	6 800	—	TPK5570J	—	—	57.4	65.2	—	20	—
—	55.9	—	76	1.984	—	0.8	—	0.8	16.2	91.9	6 500	—	TVK5676JL	—	—	60.6	69.8	—	40	—
—	55.9	—	76.6	1.984	—	1.1	—	0.8	16.2	91.9	6 500	—	TVK5677JL	—	—	60.6	69.8	—	41	—
—	57	70.8	71	1.984	—	—	—	0.8	14.6	80.7	6 700	—	TVK5771L	—	—	61.8	69.8	—	20	—
60	60	85	85	3	1	—	5	—	38.3	218	5 000	TP6085	—	W6085F WS6085F	81	65.4	40	—	22	112
—	60.4	—	78	2	—	0.8	—	0.8	17.9	107	6 400	—	TPK6078JL	—	—	65.6	73.6	—	38	—
62	—	80.25	—	2	—	—	—	—	23.3	151	6 300	TP6280A	—	—	65.2	76.8	20	—	—	—
—	63	77.73	78	2	—	—	—	0.8	13.6	75.5	6 400	—	TVK6378L	—	—	68	76	—	23	—
65	65	90	90	3	1	—	5	—	40.1	236	4 900	TP6590	—	W6590F WS6590F	86	70.4	43	—	24	119
70	70	95	95	4	1	—	3	—	52.1	275	4 100	TP7095	—	W7095F WS7095F	74.2	90.2	70	—	25	75
70.03	—	92.37	—	3.175	—	—	—	—	33.4	181	4 700	TV7092A	—	—	75	87.4	34	—	—	—

# Needle roller thrust bearings

$d$  ( $d_1$ ) 71.9 ~ 100 mm

Separable type

Non-separable type

Needle roller and cage thrust assembly

Race

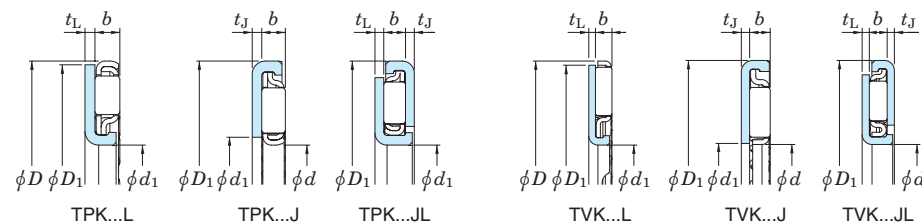
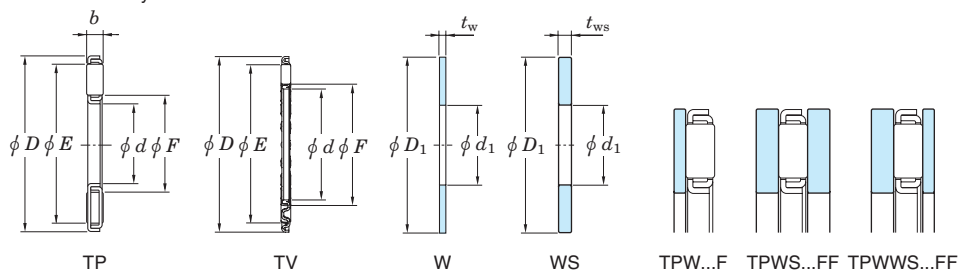

Boundary dimensions (mm)									Basic load ratings (kN)		Limiting speeds (min <sup>-1</sup> )	Bearing No.			Dimensions (mm)		(Refer.) Mass (g)				
$d$	$d_1$	$D$	$D_1$	$b$	$t_w$	$t_J$	$t_{ws}$	$t_L$	$C_a$	$C_{0a}$	Oil lub.	Needle roller and cage thrust ass'y Separable type	Thin plate race (pressed)	Thick plate race (machined)	$E$	$F$	$\left[ \begin{matrix} TP \\ TV \end{matrix} \right]$	$\left[ \begin{matrix} TPK \\ TVK \end{matrix} \right]$	(W)	(WS)	
—	<b>71.9</b>	85.6	85.5	2	—	0.8	—	—	14.1	82.4	6 100	—	<b>TPK7286L</b>	—	—	76.5	83.1	—	27	—	—
—	<b>73.6</b>	—	89.6	2	—	0.8	—	0.8	10	52.6	6 000	—	<b>TPK7490JL</b>	—	—	78	84.6	—	41	—	—
<b>75</b>	<b>75</b>	100	100	4	2	—	5	—	46.7	243	4 000	<b>TP75100</b>	—	<b>W75100F</b>	<b>WS75100F</b>	95	79.4	63	—	54	135
<b>80</b>	<b>80</b>	105	105	4	1	—	6	—	47.8	255	3 900	<b>TP80105</b>	—	<b>W80105F</b>	<b>WS80105F</b>	100	84.4	67	—	29	171
<b>82.68</b>	—	114.3	—	9.525	—	—	—	—	117	453	2 400	<b>TP83114</b>	—	—	—	88.6	109	218	—	—	—
—	<b>83.1</b>	—	104	2	—	2	—	0.8	14.7	90	5 500	—	<b>TVK83104JL</b>	—	—	88.8	96.8	—	77	—	—
<b>85</b>	<b>85</b>	110	110	4	1	—	6	—	48.9	266	3 800	<b>TP85110</b>	—	<b>W85110F</b>	<b>WS85110F</b>	105	89.4	70	—	30	180
<b>90</b>	<b>90</b>	120	120	4	1	—	6	—	60.9	362	3 600	<b>TP90120</b>	—	<b>W90120F</b>	<b>WS90120F</b>	115	95.4	92	—	39	234
<b>100</b>	<b>100</b>	135	135	4	1	—	6	—	76.3	503	3 400	<b>TP100135</b>	—	<b>W100135F</b>	<b>WS100135F</b>	130	106.4	122	—	51	304

# Stud type track rollers (cam followers) CM (full complement type)

D 16 ~ 90 mm

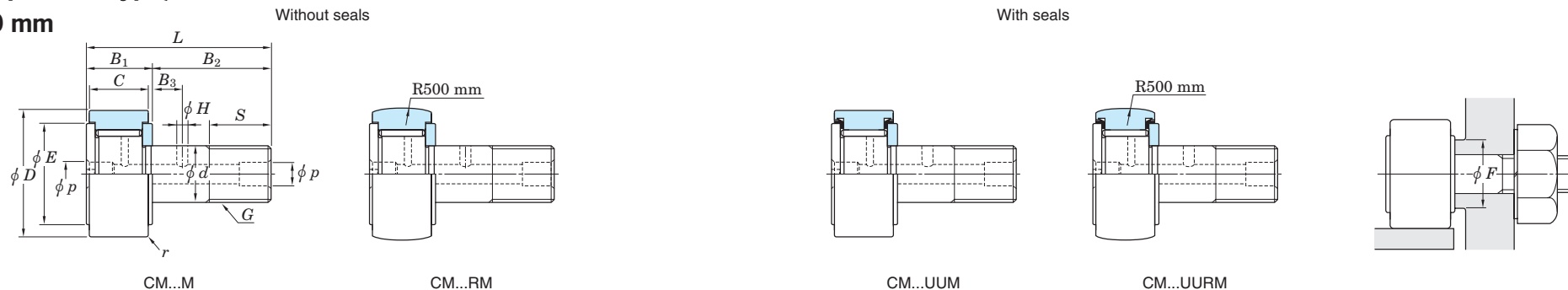

Outer ring	Boundary dimensions (mm)										Bearing No.		With seals		Clamping dia. F (mm)	Track roller load ratings <sup>2)</sup>		JIS Basic load ratings <sup>3)</sup>		Track capacity <sup>4)</sup> (kN)	Limiting speeds <sup>5)</sup> (min <sup>-1</sup> )		Tightening torque <sup>6)</sup> (N·m) max.	(Refer.) Mass (CM...M type) (kg)		
	D	C	r <sub>min.</sub>	d	L	B <sub>1</sub>	B <sub>2</sub>	E	G	S	B <sub>3</sub>	H	p	Cylindrical outer ring		Crowned outer ring	Cylindrical outer ring	Crowned outer ring	C <sub>t</sub> (kN)		P <sub>max</sub> (kN)	C <sub>r</sub> (kN)			C <sub>0r</sub> (kN)	Grease lub.
16	11	0.3	6	28	12	16	12	M6×1	9	—	—	4 <sup>1)</sup>	CM6M	CM6RM	CM6UUM	CM6UURM	10.5	5.85	2.25	7.00	8.25	3.55	9 200	13 000	3.0	0.019
19	11	0.3	8	32	12	20	15	M8×1.25	11	—	—	4 <sup>1)</sup>	CM8M	CM8RM	CM8UUM	CM8UURM	12.5	6.70	5.20	8.05	10.4	4.25	8 200	12 000	7.3	0.029
22	12	0.5	10	36	13	23	17	M10×1.25	13	—	—	4	CM10M	CM10RM	CM10UUM	CM10UURM	15	7.80	9.30	9.35	12.3	5.20	7 200	10 000	15	0.044
26	12	0.5	10	36	13	23	17	M10×1.25	13	—	—	4	CM10-1M	CM10-1RM	CM10-1UUM	CM10-1UURM	15	7.80	9.30	9.35	12.3	6.15	7 200	10 000	15	0.056
30	14	1	12	40	15	25	22	M12×1.5	14	6	3	6	CM12M	CM12RM	CM12UUM	CM12UURM	19	11.0	13.9	13.2	18.0	7.75	5 900	8 300	26	0.089
32	14	1	12	40	15	25	22	M12×1.5	14	6	3	6	CM12-1M	CM12-1RM	CM12-1UUM	CM12-1UURM	19	11.0	13.9	13.2	18.0	8.25	5 900	8 300	26	0.099
35	18	1	16	52	19.5	32.5	27	M16×1.5	18	8	3	6	CM16M	CM16RM	CM16UUM	CM16UURM	24	16.8	25.7	20.2	33.9	12.0	4 600	6 400	64	0.171
40	20	1.5	18	58	21.5	36.5	32	M18×1.5	20	8	3	6	CM18M	CM18RM	CM18UUM	CM18UURM	27	19.2	31.9	23.1	38.2	14.6	4 000	5 700	92	0.248
47	24	1.5	20	66	25.5	40.5	36	M20×1.5	22	9	4	8	CM20M	CM20RM	CM20UUM	CM20UURM	30.5	25.6	39.1	30.7	57.2	21.2	3 600	5 000	130	0.393
52	24	1.5	20	66	25.5	40.5	36	M20×1.5	22	9	4	8	CM20-1M	CM20-1RM	CM20-1UUM	CM20-1UURM	30.5	25.6	39.1	30.7	57.2	23.5	3 600	5 000	130	0.455
62	29	1.5	24	80	30.5	49.5	44	M24×1.5	25	11	4	8	CM24M	CM24RM	CM24UUM	CM24UURM	37.5	38.8	55.7	46.5	92.0	34.6	2 900	4 100	220	0.810
72	29	2	24	80	30.5	49.5	44	M24×1.5	25	11	4	8	CM24-1M	CM24-1RM	CM24-1UUM	CM24-1UURM	37.5	38.8	55.7	46.5	92.0	38.7	2 900	4 100	220	1.05
80	35	2	30	100	37	63	58	M30×1.5	32	15	4	8	CM30M	CM30RM	CM30UUM	CM30UURM	51	64.0	95.2	76.8	159	53.3	2 100	3 000	440	1.64
85	35	2	30	100	37	63	58	M30×1.5	32	15	4	8	CM30-1M	CM30-1RM	CM30-1UUM	CM30-1UURM	51	64.0	95.2	76.8	159	56.6	2 100	3 000	440	1.81
90	35	2	30	100	37	63	58	M30×1.5	32	15	4	8	CM30-2M	CM30-2RM	CM30-2UUM	CM30-2UURM	51	64.0	95.2	76.8	159	60.0	2 100	3 000	440	2.00

[Notes] 1) Stud type track rollers with no lubrication hole on the stud threaded end.  
 2) To calculate track roller rated service life, use these track roller load rating (C<sub>t</sub>). Numerical values P<sub>max</sub> refer to maximum load track roller can accommodate. If track roller is fixed in housing as with regular type bearings, JIS basic static load rating values (C<sub>0r</sub>) may apply.  
 3) If track roller is fixed in housing, as with regular type bearings, rated service life can be calculated using JIS basic dynamic load rating values (C<sub>r</sub>).  
 4) Track capacity is described earlier in this section (p. B 386). The values listed in the table are the capacities of cylindrical track rollers.  
 5) Limiting speeds are applicable to without seals type.  
 6) Tightening torque apply when threaded portion is dry; if thread is wet with oil or other fluid, torque is half these values.

# Stud type track rollers (cam followers) KM (caged type)

D 13 ~ 90 mm

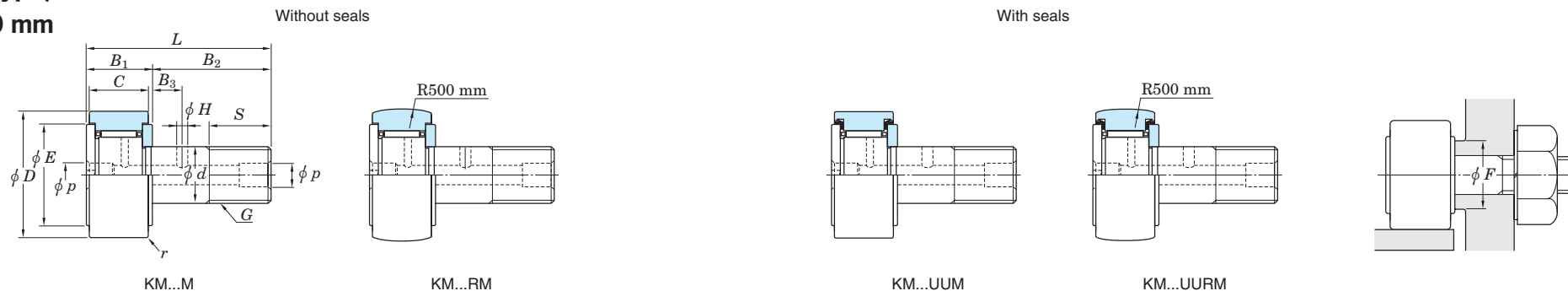

Outer ring	Boundary dimensions (mm)										Bearing No.		With seals		Clamping dia. F (mm)	Track roller load ratings <sup>2)</sup>		JIS Basic load ratings <sup>3)</sup>		Track capacity <sup>4)</sup> (kN)	Limiting speeds <sup>5)</sup> (min <sup>-1</sup> )		Tightening torque <sup>6)</sup> (N·m) max.	(Refer.) Mass (KM...M type) (kg)		
	D	C	r <sub>min.</sub>	d	L	B <sub>1</sub>	B <sub>2</sub>	E	G	S	B <sub>3</sub>	H	p	Cylindrical outer ring		Crowned outer ring	Cylindrical outer ring	Crowned outer ring	C <sub>t</sub> (kN)		P <sub>max</sub> (kN)	C <sub>r</sub> (kN)			C <sub>0r</sub> (kN)	Grease lub.
13	9	0.3	5	23	10	13	10	M5×0.8	7.5	—	—	3 <sup>1)</sup>	KM5M	KM5RM	KM5UUM	KM5UURM	9.0	2.20	1.60	2.65	2.45	2.35	16 000	22 000	1.8	0.010
16	11	0.3	6	28	12	16	12	M6×1	9	—	—	4 <sup>1)</sup>	KM6M	KM6RM	KM6UUM	KM6UURM	10.5	3.40	2.25	4.10	4.05	3.55	15 000	20 000	3.0	0.018
19	11	0.3	8	32	12	20	15	M8×1.25	11	—	—	4 <sup>1)</sup>	KM8M	KM8RM	KM8UUM	KM8UURM	12.5	3.80	4.10	4.55	4.90	4.25	13 000	18 000	7.3	0.028
22	12	0.5	10	36	13	23	17	M10×1.25	13	—	—	4	KM10M	KM10RM	KM10UUM	KM10UURM	15	5.20	6.05	6.25	7.25	5.20	11 000	16 000	15	0.043
26	12	0.5	10	36	13	23	17	M10×1.25	13	—	—	4	KM10-1M	KM10-1RM	KM10-1UUM	KM10-1UURM	15	5.20	6.05	6.25	7.25	6.15	11 000	16 000	15	0.055
30	14	1	12	40	15	25	22	M12×1.5	14	6	3	6	KM12M	KM12RM	KM12UUM	KM12UURM	19	6.80	8.00	8.20	9.60	7.75	9 500	13 000	26	0.087
32	14	1	12	40	15	25	22	M12×1.5	14	6	3	6	KM12-1M	KM12-1RM	KM12-1UUM	KM12-1UURM	19	6.80	8.00	8.20	9.60	8.25	9 500	13 000	26	0.096
35	18	1	16	52	19.5	32.5	27	M16×1.5	18	8	3	6	KM16M	KM16RM	KM16UUM	KM16UURM	24	10.8	15.8	13.0	18.9	12.0	7 400	10 000	64	0.166
40	20	1.5	18	58	21.5	36.5	32	M18×1.5	20	8	3	6	KM18M	KM18RM	KM18UUM	KM18UURM	27	13.3	19.6	15.9	23.5	14.6	6 500	8 900	92	0.245
47	24	1.5	20	66	25.5	40.5	36	M20×1.5	22	9	4	8	KM20M	KM20RM	KM20UUM	KM20UURM	30.5	17.7	29.5	21.3	35.4	21.2	5 700	7 900	130	0.387
52	24	1.5	20	66	25.5	40.5	36	M20×1.5	22	9	4	8	KM20-1M	KM20-1RM	KM20-1UUM	KM20-1UURM	30.5	17.7	29.5	21.3	35.4	23.5	5 700	7 900	130	0.453
62	29	1.5	24	80	30.5	49.5	44	M24×1.5	25	11	4	8	KM24M	KM24RM	KM24UUM	KM24UURM	37.5	26.3	46.1	31.6	55.3	34.6	4 600	6 400	220	0.801
72	29	2	24	80	30.5	49.5	44	M24×1.5	25	11	4	8	KM24-1M	KM24-1RM	KM24-1UUM	KM24-1UURM	37.5	26.3	46.1	31.6	55.3	38.7	4 600	6 400	220	1.04
80	35	2	30	100	37	63	58	M30×1.5	32	15	4	8	KM30M	KM30RM	KM30UUM	KM30UURM	51	46.5	86.9	55.8	104	53.3	3 400	4 700	440	1.62
85	35	2	30	100	37	63	58	M30×1.5	32	15	4	8	KM30-1M	KM30-1RM	KM30-1UUM	KM30-1UURM	51	46.5	86.9	55.8	104	56.6	3 400	4 700	440	1.79
90	35	2	30	100	37	63	58	M30×1.5	32	15	4	8	KM30-2M	KM30-2RM	KM30-2UUM	KM30-2UURM	51	46.5	86.9	55.8	104	60.0	3 400	4 700	440	1.98

[Notes] 1) Stud type track rollers with no lubrication hole on the stud threaded end.  
 2) To calculate track roller rated service life, use these track roller load rating (C<sub>t</sub>). Numerical values P<sub>max</sub> refer to maximum load track roller can accommodate. If track roller is fixed in housing as with regular type bearings, JIS basic static load rating values (C<sub>0r</sub>) may apply.  
 3) If track roller is fixed in housing, as with regular type bearings, rated service life can be calculated using JIS basic dynamic load rating values (C<sub>r</sub>).  
 4) Track capacity is described earlier in this section (p. B 386). The values listed in the table are the capacities of cylindrical track rollers.  
 5) Limiting speeds are applicable to without seals type.  
 6) Tightening torque apply when threaded portion is dry; if thread is wet with oil or other fluid, torque is half these values.

# Yoke type track rollers (roller followers) CYM (full complement type)

$d$  5 ~ 50 mm

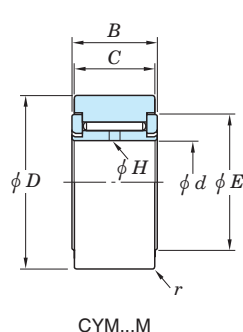

CYM...M

Without seals

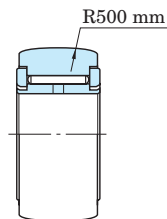

CYM...RM

With seals

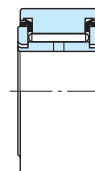

CYM...UUM

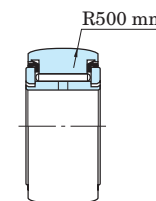

CYM...UURM

$d$	Boundary dimensions (mm)						Bearing No.				Track roller load ratings <sup>2)</sup>		JIS Basic load ratings <sup>3)</sup>		Track capacity <sup>4)</sup>	Limiting speeds <sup>5)</sup> (min <sup>-1</sup> )		(Refer.) Mass (CYM...M type) (kg)
	$D$	$B$	$C$	$r_{min.}$	$E$	$H^1$	Without seals Cylindrical outer ring	Without seals Crowned outer ring	With seals Cylindrical outer ring	With seals Crowned outer ring	$C_t$ (kN)	$P_{max}$ (kN)	$C_r$ (kN)	$C_{or}$ (kN)	(kN)	Grease lub.	Oil lub.	
5	16	12	11	0.3	12	2	CYM5M	CYM5RM	CYM5UUM	CYM5UURM	5.85	6.85	7.00	8.25	3.55	9 200	13 000	0.014
6	19	12	11	0.3	15	2	CYM6M	CYM6RM	CYM6UUM	CYM6UURM	6.70	8.70	8.05	10.4	4.25	8 200	12 000	0.021
8	24	15	14	0.5	18	2	CYM8M	CYM8RM	CYM8UUM	CYM8UURM	9.55	12.6	11.5	15.1	6.70	6 800	9 500	0.043
10	30	15	14	1	22	2	CYM10M	CYM10RM	CYM10UUM	CYM10UURM	11.1	15.1	13.3	18.1	7.75	5 900	8 300	0.062
12	32	15	14	1	24	2	CYM12M	CYM12RM	CYM12UUM	CYM12UURM	11.9	17.3	14.3	20.7	8.25	5 300	7 400	0.069
15	35	19	18	1	27	2	CYM15M	CYM15RM	CYM15UUM	CYM15UURM	16.8	28.2	20.2	33.9	12.0	4 600	6 400	0.105
17	40	21	20	1.5	32	2.4	CYM17M	CYM17RM	CYM17UUM	CYM17UURM	19.2	31.8	23.1	38.2	14.6	4 000	5 700	0.153
20	47	25	24	1.5	36	2.4	CYM20M	CYM20RM	CYM20UUM	CYM20UURM	25.6	47.7	30.7	57.3	21.2	3 600	5 000	0.255
25	52	25	24	1.5	41	2.4	CYM25M	CYM25RM	CYM25UUM	CYM25UURM	28.4	58.2	34.1	69.8	23.5	3 000	4 200	0.284
30	62	29	28	1.5	51	3.2	CYM30M	CYM30RM	CYM30UUM	CYM30UURM	41.5	88.8	49.8	107	33.3	2 400	3 400	0.476
35	72	29	28	2	58	3.2	CYM35M	CYM35RM	CYM35UUM	CYM35UURM	47.4	99.4	56.9	119	37.1	2 100	2 900	0.649
40	80	32	30	2	63	3.2	CYM40M	CYM40RM	CYM40UUM	CYM40UURM	58.3	122	70.0	147	44.7	1 900	2 600	0.845
45	85	32	30	2	69	3.2	CYM45M	CYM45RM	CYM45UUM	CYM45UURM	61.4	135	73.7	162	47.5	1 700	2 400	0.924
50	90	32	30	2	75	3.2	CYM50M	CYM50RM	CYM50UUM	CYM50UURM	64.2	148	77.0	177	50.3	1 600	2 200	0.984

[Notes] 1) Lubrication hole is provided on inner ring internal surface.  
 2) To calculate track roller rated service life, use these track roller load rating values ( $C_t$ ). Numerical values  $P_{max}$  refer to maximum load track roller can accommodate. If track roller is fixed in housing as with regular type bearings, JIS basic static load rating values ( $C_{or}$ ) may apply.  
 3) If track roller is fixed in housing, as with regular type bearings, rated service life can be calculated using JIS basic dynamic load rating values ( $C_r$ ).

4) Track capacity is described earlier in this section (p. B 386). The values listed in the above table are the capacities of cylindrical track rollers. The track capacities of crowned track rollers are 80 % of these values.  
 5) Limiting speeds are as measured with no seals.

# Yoke type track rollers (roller followers) CXM (caged type)

d 5 ~ 50 mm

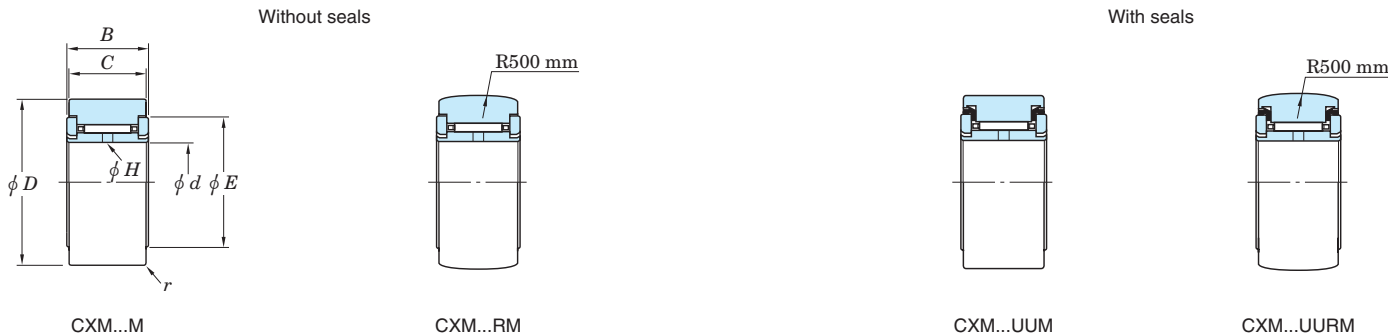

d	Boundary dimensions (mm)						Bearing No.				Track roller load ratings <sup>2)</sup>		JIS Basic load ratings <sup>3)</sup>		Track capacity <sup>4)</sup>	Limiting speeds <sup>5)</sup> (min <sup>-1</sup> )		(Refer.) Mass (CXM...M type) (kg)
	D	B	C	r <sub>min.</sub>	E	H <sup>1)</sup>	Without seals		With seals		C <sub>t</sub> (kN)	P <sub>max</sub> (kN)	C <sub>r</sub> (kN)	C <sub>0r</sub> (kN)	(kN)	Grease lub.	Oil lub.	
							Cylindrical outer ring	Crowned outer ring	Cylindrical outer ring	Crowned outer ring								
5	16	12	11	0.3	12	2	<b>CXM5M</b>	<b>CXM5RM</b>	<b>CXM5UUM</b>	<b>CXM5UURM</b>	3.40	3.40	4.10	4.05	3.55	15 000	20 000	0.011
6	19	12	11	0.3	15	2	<b>CXM6M</b>	<b>CXM6RM</b>	<b>CXM6UUM</b>	<b>CXM6UURM</b>	3.80	4.10	4.55	4.90	4.25	13 000	18 000	0.018
8	24	15	14	0.5	18	2	<b>CXM8M</b>	<b>CXM8RM</b>	<b>CXM8UUM</b>	<b>CXM8UURM</b>	5.70	6.40	6.85	7.65	6.70	11 000	15 000	0.040
10	30	15	14	1	22	2	<b>CXM10M</b>	<b>CXM10RM</b>	<b>CXM10UUM</b>	<b>CXM10UURM</b>	6.80	8.00	8.20	9.60	7.75	9 500	13 000	0.060
12	32	15	14	1	24	2	<b>CXM12M</b>	<b>CXM12RM</b>	<b>CXM12UUM</b>	<b>CXM12UURM</b>	7.25	9.05	8.70	10.8	8.25	8 400	12 000	0.067
15	35	19	18	1	27	2	<b>CXM15M</b>	<b>CXM15RM</b>	<b>CXM15UUM</b>	<b>CXM15UURM</b>	10.8	15.8	13.0	18.9	12.0	7 400	10 000	0.102
17	40	21	20	1.5	32	2.4	<b>CXM17M</b>	<b>CXM17RM</b>	<b>CXM17UUM</b>	<b>CXM17UURM</b>	13.3	19.6	15.9	23.5	14.6	6 500	8 900	0.150
20	47	25	24	1.5	36	2.4	<b>CXM20M</b>	<b>CXM20RM</b>	<b>CXM20UUM</b>	<b>CXM20UURM</b>	17.7	29.5	21.3	35.4	21.2	5 700	7 900	0.252
25	52	25	24	1.5	41	2.4	<b>CXM25M</b>	<b>CXM25RM</b>	<b>CXM25UUM</b>	<b>CXM25UURM</b>	19.2	34.6	23.0	41.5	23.5	4 800	6 600	0.278
30	62	29	28	1.5	51	3.2	<b>CXM30M</b>	<b>CXM30RM</b>	<b>CXM30UUM</b>	<b>CXM30UURM</b>	28.4	53.9	34.0	64.7	33.3	3 900	5 300	0.465
35	72	29	28	2	58	3.2	<b>CXM35M</b>	<b>CXM35RM</b>	<b>CXM35UUM</b>	<b>CXM35UURM</b>	32.4	60.3	38.9	72.4	37.1	3 300	4 600	0.636
40	80	32	30	2	63	3.2	<b>CXM40M</b>	<b>CXM40RM</b>	<b>CXM40UUM</b>	<b>CXM40UURM</b>	41.4	78.1	49.7	93.7	44.7	3 000	4 100	0.825
45	85	32	30	2	69	3.2	<b>CXM45M</b>	<b>CXM45RM</b>	<b>CXM45UUM</b>	<b>CXM45UURM</b>	42.7	83.6	51.2	100	47.5	2 700	3 700	0.901
50	90	32	30	2	75	3.2	<b>CXM50M</b>	<b>CXM50RM</b>	<b>CXM50UUM</b>	<b>CXM50UURM</b>	45.5	93.9	54.6	113	50.3	2 500	3 400	0.960

[Notes] 1) Lubrication hole is provided on inner ring internal surface.  
 2) To calculate track roller rated service life, use these track roller load rating values (C<sub>t</sub>). Numerical values P<sub>max</sub> refer to maximum load track roller can accommodate. If track roller is fixed in housing as with regular type bearings, JIS basic static load rating values (C<sub>0r</sub>) may apply.  
 3) If track roller is fixed in housing, as with regular type bearings, rated service life can be calculated using JIS basic dynamic load rating values (C<sub>r</sub>).

4) Track capacity is described earlier in this section (p. B 386). The values listed in the above table are the capacities of cylindrical track rollers. The track capacities of crowned track rollers are 80 % of these values.  
 5) Limiting speeds are as measured with no seals.



# Miniature one-way clutches

Miniature one-way clutches consist of a case carburizing steel drawn cup, metal or synthetic resin spring, synthetic resin cage and needle rollers.

They are used in clutch mechanisms of various machines. Use in office automation equipment such as copying and facsimile machines is especially common.

- Useful for making equipment smaller and lighter, due to a drawn cup made of thin sheet steel.
- Locking protrusions are provided around the drawn cup, so that creeping can be prevented without having to hold the surface dimensional accuracy precisely.
- Pre-lubricated with optimum grease, so that no lubrication is necessary under normal operating conditions.
- Unit products with a synthetic resin housing are also available.

They are compatible with components of various types, such as gears, timing pulleys, cams and rubber rollers. Consult with JTEKT for further information. Refer to JTEKT catalog "miniature one-way clutch".



1WC series



EWC series



Various housings and unit products

## Structure and principles

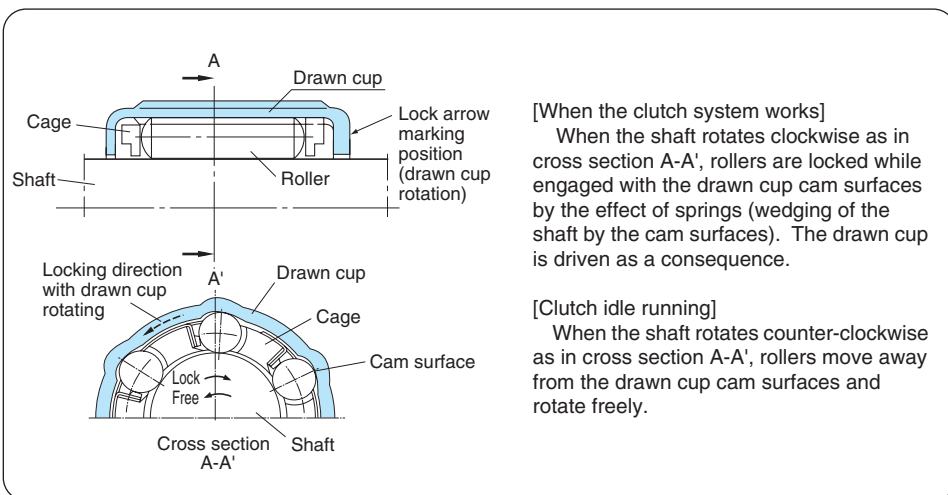

## Miniature one-way clutch types and characteristics

	1WC series (with metal springs)		EWC series (with synthetic resin springs)	
	Heavy load type		Heavy load type	Light load type
	1WC...		EWC...C	EWC...A
Torque capacity	Heavy load		Heavy load	Light load
Operating temperature range	- 10 to + 90°C		- 10 to + 70°C	
Locking life	Locking system can function more than one million. (Note : this estimation is valid as long as torque magnitude does not exceed the torque capacity shown in the specification table.)			
Insert molding	Possible		Impossible	
Delivery of clutch only	Possible			
Unit delivery	Possible			

## Shaft tolerance

	Heavy load type (1WC... , EWC...C)	Light load type (EWC...A)
Shaft tolerance class	h 8	
Surface hardness	50 HRC or harder	30 HRC or harder
Roughness (Ra)	0.3 a or less	0.8 a or less
Roundness and cylindricity	0.005 mm or less	

[Remarks] In some operating conditions, shafts need not be as accurate as shown here.

For example :

1. When clutch engaging accuracy is considered unimportant, or when a radial load or moment is not generated, the shaft diameter tolerance can be :
  - shaft diameter 6 mm or less, and EWC0809 (C, A) : 0 to - 0.040 mm
  - shaft diameter 8 mm or more : h 10
2. When the loaded torque is smaller than the torque capacity, shaft surface hardness can be determined as follows :

\* The diagram on the right shows approximate shaft surface hardness relative to torque ratio A.

$$\text{Torque ratio (A)} = \frac{\text{Loaded torque}}{\text{Heavy load type torque capacity}}$$

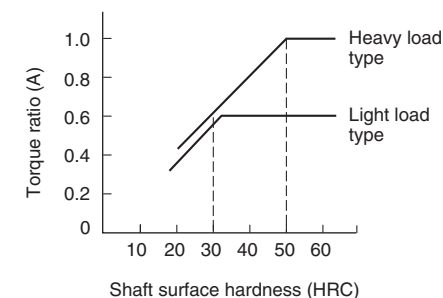

Miniature one-way clutches

*d* 4 ~ 12 mm

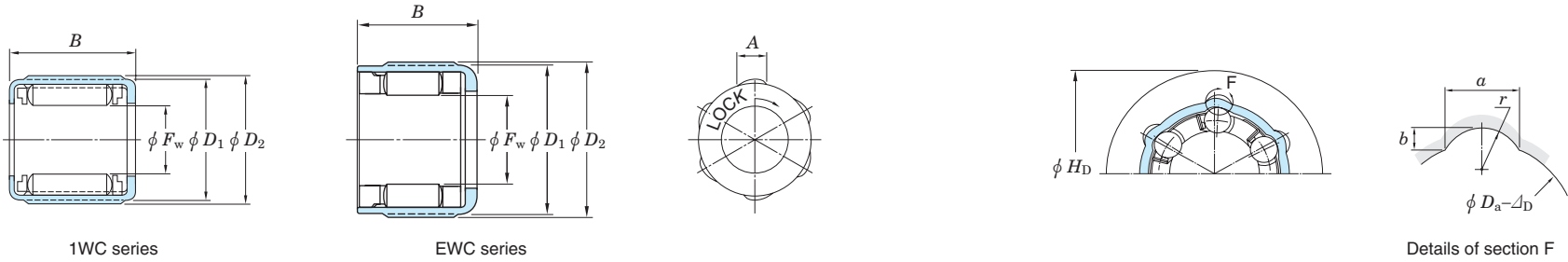

Shaft dia. (mm) <i>d</i>	Boundary dimensions (mm)					Torque capacity (N·m)	Designations		No. of <sup>1)</sup> outer ring protrusion	Recommended housing dimensions (mm)						(Refer.) Mass (g)	
	<i>F<sub>w</sub></i>	<i>D<sub>1</sub></i>	<i>D<sub>2</sub></i>	<i>B</i>	<i>A</i>		1WC series (With metal springs)	EWC series (With resin spring)		<i>H<sub>D</sub></i>	<i>a</i>	<i>b</i>	<i>r</i>	<i>D<sub>a</sub></i>	$\Delta D$ <sup>2)</sup>	1WC	EWC
4	4	8	8.4	6	2.6	0.08	—	EWC0406A	4	12	2.65	0.50	2	8	0.06	—	1.0
	4	8	8.4	6	2.6	0.15	—	EWC0406C	4	12	2.65	0.50	2	8	0.06	—	1.0
6	6	10	10.4	8	2.8	0.25	—	EWC0608A	6	14	2.8	0.57	2	10	0.08	—	1.7
	6	10	10.4	8	2.8	0.44	—	EWC0608C	6	14	2.8	0.57	2	10	0.08	—	1.7
	6	10	10.4	8	2.8	0.44	1WC0608	—	6	14	2.8	0.57	2	10	0.08	2.0	—
	6	10	10.4	12	2.8	0.88	1WC0612	—	6	14	2.8	0.57	2	10	0.08	3.0	—
8	8	12	12.4	9	2.6	0.49	—	EWC0809A	6	16	2.6	0.48	2	12	0.10	—	2.4
	8	12	12.4	9	2.6	0.88	—	EWC0809C	6	16	2.6	0.48	2	12	0.10	—	2.4
	8	14.2	15	12	3.6	1.18	—	EWC0812A	6	18.5	3.6	0.87	2.3	14.2	0.11	—	5.8
	8	14.2	15	12	3.6	1.96	—	EWC0812C	6	18.5	3.6	0.87	2.3	14.2	0.11	—	5.8
	8	14.2	15	12	3.6	1.96	1WC0812	—	6	18.5	3.6	0.87	2.3	14.2	0.11	7.0	—
	8	14.2	15	14.5	3.6	2.65	1WC0815	—	6	18.5	3.6	0.87	2.3	14.2	0.11	8.0	—
	8	14.2	15	12	3.6	2.65	1WC0815	—	6	18.5	3.6	0.87	2.3	14.2	0.11	8.0	—
10	10	16	17	10	5	1.18	—	EWC1010A	6	21	5.0	1.20	3.2	16	0.13	—	6.0
	10	16	17	10	5	1.96	—	EWC1010C	6	21	5.0	1.20	3.2	16	0.13	—	6.0
	10	16	17	12	5	1.37	—	EWC1012A	6	21	5.0	1.20	3.2	16	0.13	—	6.8
	10	16	17	12	5	2.35	—	EWC1012C	6	21	5.0	1.20	3.2	16	0.13	—	6.8
	10	16	17	12	5	2.35	1WC1012	—	6	21	5.0	1.20	3.2	16	0.13	8.0	—
12	12	18	19	16	5.1	6.28	1WC1216	—	8	23	5.1	1.20	3.3	18	0.14	12	—

[Notes] 1) Provided at equal intervals.  
2) Recommended interference when polyacetal resin housing is used.

## Ball bearing units

Ball bearing units consist of pre-lubricated sealed ball bearings and a housing which varies in shape.

They are capable of aligning themselves efficiently using the spherical fitting surface between the bearing and housing, effectively preventing overloads due to misalignment.

Koyo ball bearing units are highly accurate and feature excellent load resistance. They are completely sealed, and provided with a relubrication feature.

Ball bearing units without a relubrication feature are also available.

For details, refer to JTEKT separate catalog "Ball bearing units" (CAT. NO. B2007E).



### Pillow block type



Bore diameter 12 – 140 mm

### Flanged type

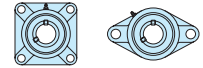

Bore diameter 12 – 140 mm

### Flanged type with spigot joint



Bore diameter 12 – 140 mm

### Take-up type



Bore diameter 12 – 140 mm

### Cartridge type



Bore diameter 12 – 140 mm

### Light duty units



Bore diameter 12 – 40 mm

### "Compact" series (made from light alloy)



Bore diameter 10 – 30 mm

### Stainless-series



Bore diameter 12 – 50 mm

### Pressed steel units

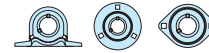

Bore diameter 12 – 35 mm







### Ball bearings for units









Bore diameter 10 – 140 mm

Typical types of ball bearing unit



(1) Cast iron units

	Pillow block type ● UCP 2·X·3 ▲ UKP 2·X·3 ■ NAP 2
	Square-flanged type ● UCF 2·X·3 ▲ UKF 2·X·3 ■ NANF 2
	Square-flanged type with spigot joint ● UCFS 3 ▲ UKFS 3
	Rhombic-flanged type ● UCFL 2·X·3 ▲ UKFL 2·X·3 ■ NANFL 2
	Round-flanged type with spigot joint ● UCFC 2·X ▲ UKFC 2·X ■ NAFC 2
	Take-up type ● UCT 2·X·3 ▲ UKT 2·X·3 ■ NAT 2
	Cartridge type ● UCC 2·X·3 ▲ UKC 2·X·3 ■ NAC 2

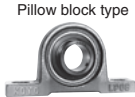

Special pillow block types    Thick section pillow block type

		
● UCPH 2	● UCPA 2	● UCIP 2·3
		▲ UKIP 2·3
		
● UCFA 2	● UCFB 2	● UCHA 2



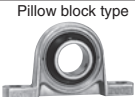

(2) Light duty units (cast iron)

	
■ BLP 2	■ BLF 2

(3) "Compact" series units (special light alloy)

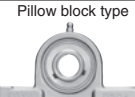
	
● UP 0	● UFL 0



(4) Stainless-series units (stainless steel)

	
● UCSP 2...H1S6	● UCSFL 2...H1S6
	
● USP 0...S6	● USFL 0...S6





(5) Pressed steel units

		
● SBPP2	● SBPFL2	● SBPF2

(6) Take-up units with frame

	
● UCTH 2	● UCTL 2
● SBNPTH 2	● UCTU 2
● SBPTH 2	● UCTU 3

(7) Ball bearings for units

	Cylindrical bore type (with set screws) ● UC 2·X·3 ● SB 2 ● SU 0		Cylindrical bore type (with set screws) ● RB 2 (Sealed deep groove ball bearings having an extended inner ring.)
	Tapered bore type (with adapter) ▲ UK 2·X·3		Cylindrical bore type (with set screws) ● ER 2 (Sealed deep groove ball bearings having an extended inner ring and an outer ring provided with a locating snap ring, lubrication groove and lubrication holes.)
	Cylindrical bore type (with eccentric locking collar) ■ NA 2		

[Note] This catalog includes the specifications of major units and bearings which are boxed in the table. For further details, refer to a separate catalog. Marks ●, ▲ and ■ indicate, respectively, that the unit or bearing is fixed with a set screw, adapter, or eccentric locking collar.

Tolerances	· Ball bearings ..... as specified in JIS B 1558 (Tables 1 and 2). (refer to Table 7-11, class 0 on p. A 70 for the tapered bore tolerance.) · Housings.....as specified in JIS B 1559. (the internal spherical diameter tolerance is given in Table 3. For other tolerances, refer to a separate catalog.)
Bearing radial internal clearance	As specified in JIS B 1520 (Table 10-2 on p. A 96). JTEKT provides cylindrical bore bearings with standard radial internal clearance. Tapered bore bearings are provided with a C 3 radial internal clearance in consideration of possible inner ring expansion caused by tightening of an adapter.
Recommended fits of inner ring and shaft (indicated by the tolerance class)	· Cylindrical bore bearings.....h 6, h 7, h 8, j 6 (k 6, k 7 and m 6 when heavy or impact load is to be supported.) · Tapered bore bearings.....h 8, h 9 · High-speed blower bearings (S5)...h 5, j 5
Rotational speed limits	See Table 4.
Allowable aligning angle	· 0.052 rad (3°) · For units with a cover, it is best if the misalignment is 0.017 rad (1°) or less to prevent the rubber seal lip on the cover and the shaft contact from distorting the seal lip.

**Table 1 Cylindrical bore bearings for units : inner ring tolerance** Unit :  $\mu\text{m}$

Nominal bore diameter $d$ (mm)		UC, SA, NA, SU, SB, RB and ER types		Bearings for blower (S5)			Single inner (outer) ring width deviation $\Delta_{Bs} (\Delta_{Cs})$		Radial runout of assembled bearing inner ring $K_{ia}$			
		Single plane mean bore diameter deviation $\Delta_{dmp}$		Single plane bore diameter variation $V_{dsp}$		Single plane mean bore diameter deviation $\Delta_{dmp}$				Single plane bore diameter variation $V_{dsp}$		
		upper	lower	max.	upper	lower				max.	upper	lower
over	up to								max.			
10 more	18	+15	0	10	+13	0	6	0	-120	15		
18	31.75	+18	0	12	+13	0	6	0	-120	18		
31.75	50.8	+21	0	14	+13	0	10	0	-120	20		
50.8	80	+24	0	16	+15	0	10	0	-150	25		
80	120	+28	0	19	+18	0	14	0	-200	30		
120	180	+33	0	22	+23	0	14	0	-250	35		

**Table 2 Ball bearings for units : outer ring tolerance** Unit :  $\mu\text{m}$

Nominal outside diameter $D$ (mm)		Mean outside diameter deviation $\Delta_{Dm}$		Radial runout of assembled bearing outer ring $K_{ea}$
		upper	lower	
over	up to			
30	50	0	-11	20
50	80	0	-13	25
80	120	0	-15	35
120	150	0	-18	40
150	180	0	-25	45
180	250	0	-30	50
250	315	0	-35	60

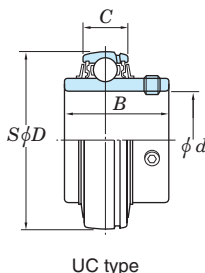

[Note] The lower value of mean outside diameter deviation does not apply to the sides of outer rings up to the extent of a quarter of the outer ring width from the side faces.

**Table 3 Housing bore internal spherical diameter tolerance** Unit :  $\mu\text{m}$

Nominal spherical bore diameter $D_a$ (mm)		Tolerance class H		Tolerance class J		Tolerance class K	
		Deviation of spherical bearing seat dia. $\Delta_{Dam}$		Deviation of spherical bearing seat dia. $\Delta_{Dam}$		Deviation of spherical bearing seat dia. $\Delta_{Dam}$	
		upper	lower	upper	lower	upper	lower
over	up to						
30	50	+25	0	+14	-11	+7	-18
50	80	+30	0	+18	-12	+9	-21
80	120	+35	0	+22	-13	+10	-25
120	180	+40	0	+26	-14	+12	-28
180	250	+46	0	+30	-16	+13	-33
250	315	+52	0	+36	-16	+16	-36

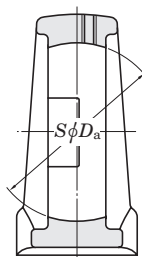

[Remark] JTEKT generally applies class J to housing designs. Class H and class K can also be applied depending on the application.

**Table 4 Limiting speed of ball bearing units** Unit :  $\text{min}^{-1}$

Bore diameter No.	Standard Cold resistant type (D2K2)			Triple-lip sealed (L3)			For high speed rotation (K3 and S5)			Heat resistant type (D1K2)
	Diameter series			Diameter series			Diameter series			Diameter series
	2	X	3	2	X	3	2	X	3	2, X, 3
01	5 800			2 300			8 700			3 800
02	5 800			2 300			8 700			3 800
03	5 800			2 300			8 700			3 800
04	5 800	-	-	2 300	-	-	8 700	-	-	3 800
05	5 100	4 300	4 600	2 100	960		7 700	6 400	6 700	3 000
06	4 300	3 700	3 900	960	830	-	6 400	5 500	5 800	2 500
07	3 700	3 300	3 400	830	750	770	5 500	5 000	5 100	2 100
08	3 300	3 100	3 100	750	690	690	5 000	4 600	4 600	1 900
09	3 100	2 800	2 700	690	640	620	4 600	4 300	4 100	1 700
10	2 800	2 500	2 400	640	570	550	4 300	3 800	3 700	1 500
11	2 500	2 300	2 300	570	520	510	3 800	3 500	3 400	1 400
12	2 300	2 200	2 100	520	490	470	3 500	3 200	3 100	1 300
13	2 200	2 100	1 900	490	460	440	3 200	3 100	2 900	1 200
14	2 100	2 000	1 800	460	440	410	3 100	2 900	2 700	1 100
15	2 000	1 800	1 700	440	410	380	2 900	2 700	2 600	1 000
16	1 800	1 700	1 600	410	380	360	2 700	2 600	2 400	940
17	1 700	1 600	1 500	380	360	340	2 600	2 400	2 300	880
18	1 600	1 500	1 400	360	340	320	2 400	2 300	2 100	830
19		-	1 400		-	310		-	2 000	790
20		1 300	1 300		300	280		2 000	1 900	750
21		-	1 200		-	270		-	1 800	710
22			1 100			250			1 700	680
24			1 100			240			1 600	630
26			1 000			220			1 500	580
28			910			200			1 400	540

[Remarks] 1. The rotational speed limits of units with a cover are 80 % of the values given in the table above.  
2. When bearings are fit loosely, rotational speed limits should be compensated for by the fitting coefficient given below.

Bearing type	Fitting coefficient					
	Shaft tolerance class					
	h5, j5	j6	h6	h7	h8	h9
Standard	-	1.0	1.0	0.8	0.5	0.2
Triple-lip sealed (L3)	-	-	-	1.0	1.0	0.9
For high speed rotation (K3)	-	1.0	0.8	0.6	-	-
For blower (S5)	1.0	-	0.8	0.6	-	-
Heat-resistant type B (D1K2)	-	-	-	1.0	1.0	0.7

[Recommended shaft design]

**Table 5 Shaft fits for cylindrical bore bearing  
-Clearance fit or transition fit-**

Unit :  $\mu\text{m}$

Shaft diameter (mm)		Tolerance of shaft							
		j6		h6		h7		h8	
over	up to	upper	lower	upper	lower	upper	lower	upper	lower
10	18	+ 8	- 3	0	- 11	0	- 18	0	- 27
18	30	+ 9	- 4	0	- 13	0	- 21	0	- 33
30	50	+ 11	- 5	0	- 16	0	- 25	0	- 39
50	80	+ 12	- 7	0	- 19	0	- 30	0	- 46
80	120	+ 13	- 9	0	- 22	0	- 35	0	- 54
120	180	+ 14	- 11	0	- 25	0	- 40	0	- 63
Operating speed $dn^{1)}$		120 000 over		100 000 over 120 000 up to		60 000 over 100 000 up to		60 000 up to	

[Note] 1)  $dn = d$  (Bearing bore, mm)  $\times$   $n$  (Rotating speed,  $\text{min}^{-1}$ )

**Table 6 Shaft fits for cylindrical bore bearing  
-Transition fit or Interference fit-**

Unit :  $\mu\text{m}$

Shaft diameter (mm)		Tolerance of shaft					
		k6		k7		m6	
over	up to	upper	lower	upper	lower	upper	lower
10	18	+12	+1	+19	+1	+18	+7
18	30	+15	+2	+23	+2	+21	+8
30	50	+18	+2	+27	+2	+25	+9
50	80	+21	+2	+32	+2	+30	+11
80	120	+25	+3	+38	+3	+35	+13
120	180	+28	+3	+43	+3	+40	+15

**Table 7 Shaft fits for bearings for blower**

Unit :  $\mu\text{m}$

Shaft diameter (mm)		Tolerance of shaft			
		h5		j5	
over	up to	upper	lower	upper	lower
10	18	0	- 8	+5	- 3
18	30	0	- 9	+5	- 4
30	50	0	- 11	+6	- 5
50	80	0	- 13	+6	- 7
80	120	0	- 15	+6	- 9
120	180	0	- 18	+7	- 11

**Table 8 Shaft fits for tapered bore bearing**

Unit :  $\mu\text{m}$

Shaft diameter (mm)		Tolerance of shaft			
		h8		h9	
over	up to	upper	lower	upper	lower
10	18	0	- 27	0	- 43
18	30	0	- 33	0	- 52
30	50	0	- 39	0	- 62
50	80	0	- 46	0	- 74
80	120	0	- 54	0	- 87
120	180	0	- 63	0	- 100

**Table 9 Recommended tolerances of  
shaft used for ball bearing units**

Unit :  $\mu\text{m}$

Shaft diameter (mm)		Deviation from circular and cylindrical forms (max.)
	10	6
10	18	8
18	30	9
30	50	11
50	80	13
80	120	15
120	180	18

**Table 10 Shaft shoulder dia. and fillet radius**

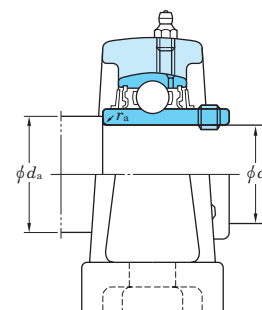

Unit :  $\mu\text{m}$

Bore No.	Nominal bore dia.	UC200, UCX00		UC300	
		$d_a$	$r_a$ (max.)	$d_a$	$r_a$ (max.)
01	12	17	0.6		
02	15	20	0.6		
03	17	22	0.6		
04	20	30	1	-	-
05	25	35	1	35	1
06	30	40	1	40	1
07	35	45	1	45	1.5
08	40	50	1	50	1.5
09	45	55	1	55	1.5
10	50	60	1	60	2
11	55	65	1.5	65	2
12	60	70	1.5	75	2
13	65	75	1.5	80	2
14	70	80	1.5	85	2
15	75	85	1.5	90	2
16	80	90	2	95	2
17	85	95	2	100	2.5
18	90	100	2	105	2.5
19	95	-	-	110	2.5
20	100	115	2	115	2.5
21	105	-	-	120	2.5
22	110			125	2.5
24	120			135	2.5
26	130			150	3
28	140			160	3



**Ball bearing units**  
**pillow block type**  
**UCP (with set screws)**  
*d* 12 ~ (55) mm

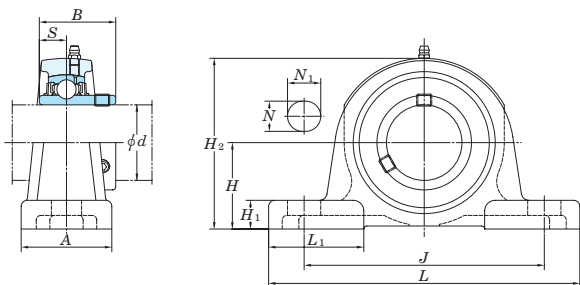

Pressed steel covers

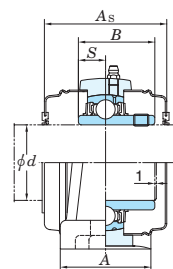

Cast iron covers

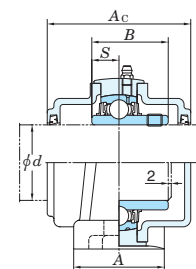

Tolerance for housing

unit : mm

housing No.			$\Delta H_s$
P203~P210	PX05~PX10	P305~P310	$\pm 0.15$
P211~P218	PX11~PX18	P311~P318	$\pm 0.2$
	PX20	P319~P328	$\pm 0.3$

$\Delta H_s$  : deviation of distance from mounting base to centre of spherical bearing seating.

P204JE3, P205JE3 (with cast iron covers) are shown below.

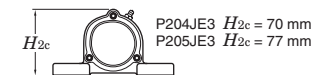

Shaft dia. (mm) <i>d</i>	Dimensions (mm)											Bolt size	Unit No.	Housing No.	Applicable bearing			Unit No. with covers				Cover dimensions (mm) <i>A<sub>s</sub></i> <i>A<sub>c</sub></i>	(Refer.) Unit mass (kg)				
	<i>H</i>	<i>L</i>	<i>A</i>	<i>J</i>	<i>N</i>	<i>N<sub>1</sub></i>	<i>H<sub>1</sub></i>	<i>H<sub>2</sub></i>	<i>L<sub>1</sub></i>	<i>B</i>	<i>S</i>				No.	Basic load ratings (kN)		Factor		Pressed steel covers			Cast iron covers		Pressed steel covers	Cast iron covers	
	<i>C<sub>r</sub></i>	<i>C<sub>0r</sub></i>	<i>f<sub>0</sub></i>	Open ends	Closed end	Open ends	Closed end	<i>A<sub>s</sub></i>	<i>A<sub>c</sub></i>	Steel covers	Cast iron covers																
12	30.2	127	38	95	13	18	12	60	38	31	12.7	M10	UCP201	P203	UC201	12.8	6.65	13.2	UCP201C	UCP201CD	—	—	44	—	0.63	—	
	15	30.2	127	38	95	13	18	12	60	38	31	12.7	M10	UCP202	P203	UC202	12.8	6.65	13.2	UCP202C	UCP202CD	—	—	44	—	0.61	—
		17	30.2	127	38	95	13	18	12	60	38	31	12.7	M10	UCP203	P203	UC203	12.8	6.65	13.2	UCP203C	UCP203CD	—	—	44	—	0.60
20	33.3	127	38	95	13	18	13	64	38	31	12.7	M10	UCP204	P204	UC204	12.8	6.65	13.2	UCP204C	UCP204CD	UCP204FC	UCP204FCD	44	62	0.66	0.96	
	25	36.5	140	38	105	13	18	13	71	43	34.1	14.3	M10	UCP205	P205	UC205	14.0	7.85	13.9	UCP205C	UCP205CD	UCP205FC	UCP205FCD	48	66	0.80	1.2
		44.4	159	51	119	17	25	16	86	47	38.1	15.9	M14	UCPX05	PX05	UCX05	19.5	11.3	13.9	UCPX05C	UCPX05CD	—	—	52	—	1.5	—
45	175	45	132	17	20	16	85	55	38	15	M14	UCP305	P305	UC305	21.2	10.9	12.6	—	—	UCP305C	UCP305CD	—	76	1.7	2.3		
30	42.9	165	48	121	17	21	15	84	53	38.1	15.9	M14	UCP206	P206	UC206	19.5	11.3	13.9	UCP206C	UCP206CD	UCP206FC	UCP206FCD	52	70	1.3	1.8	
	47.6	175	57	127	17	25	17	93	55	42.9	17.5	M14	UCPX06	PX06	UCX06	25.7	15.4	13.9	UCPX06C	UCPX06CD	—	—	59	—	2.1	—	
	50	180	50	140	17	20	17	95	53	43	17	M14	UCP306	P306	UC306	26.7	15.0	13.3	—	—	UCP306C	UCP306CD	—	82	2.2	2.8	
35	47.6	167	48	127	17	21	16	93	51	42.9	17.5	M14	UCP207	P207	UC207	25.7	15.4	13.9	UCP207C	UCP207CD	UCP207FC	UCP207FCD	59	78	1.6	2.3	
	54	203	57	144	17	30	19	105	64	49.2	19	M14	UCPX07	PX07	UCX07	29.1	17.8	14.0	UCPX07C	UCPX07CD	—	—	68	—	2.7	—	
	56	210	56	160	17	25	19	107	65	48	19	M14	UCP307	P307	UC307	33.4	19.3	13.2	—	—	UCP307C	UCP307CD	—	88	3.0	3.8	
40	49.2	184	54	137	17	21	17	98	57	49.2	19	M14	UCP208	P208	UC208	29.1	17.8	14.0	UCP208C	UCP208CD	UCP208FC	UCP208FCD	68	86	2.0	2.8	
	58.7	222	67	156	20	32	21	114	71	49.2	19	M16	UCPX08	PX08	UCX08	32.7	20.3	14.0	UCPX08C	UCPX08CD	—	—	68	—	3.5	—	
	60	220	60	170	17	27	19	118	65	52	19	M14	UCP308	P308	UC308	40.7	24.0	13.2	—	—	UCP308C	UCP308CD	—	96	3.8	4.8	
45	54	190	54	146	17	21	17	106	60	49.2	19	M14	UCP209	P209	UC209	32.7	20.3	14.0	UCP209C	UCP209CD	UCP209FC	UCP209FCD	68	88	2.2	3.0	
	58.7	222	67	156	20	33	21	116	71	51.6	19	M16	UCPX09	PX09	UCX09	35.1	23.3	14.4	UCPX09C	UCPX09CD	—	—	73	—	3.7	—	
	67	245	67	190	20	30	21	132	75	57	22	M16	UCP309	P309	UC309	48.9	29.5	13.3	—	—	UCP309C	UCP309CD	—	102	4.9	6.2	
50	57.2	206	60	159	20	22	19	113	63	51.6	19	M16	UCP210	P210	UC210	35.1	23.3	14.4	UCP210C	UCP210CD	UCP210FC	UCP210FCD	73	97	2.9	3.9	
	63.5	241	73	171	20	36	22	126	76	55.6	22.2	M16	UCPX10	PX10	UCX10	43.4	29.4	14.4	UCPX10C	UCPX10CD	—	—	75	—	4.6	—	
	75	275	75	212	20	35	24	148	88	61	22	M16	UCP310	P310	UC310	62.0	38.3	13.2	—	—	UCP310C	UCP310CD	—	110	6.6	8.2	
55	63.5	219	60	171	20	22	19	125	70	55.6	22.2	M16	UCP211	P211	UC211	43.4	29.4	14.4	UCP211C	UCP211CD	UCP211FC	UCP211FCD	75	99	3.6	4.8	

[Remarks] 1) Applicable sizes of grease nipples are shown below.  
A-1/4-28UNF ..... 201~210, X05~X09, 305~308  
A-PT 1/8 ..... 211~218, X10~X20, 309~328

2) For bearings with double- or triple-lip seals, unit and bearing number are suffixed by L2 or L3.  
3) For more detailed information, refer to ball bearing for unit specification tables.

**Ball bearing units  
pillow block type  
UCP (with set screws)**  
d (55) ~ 95 mm

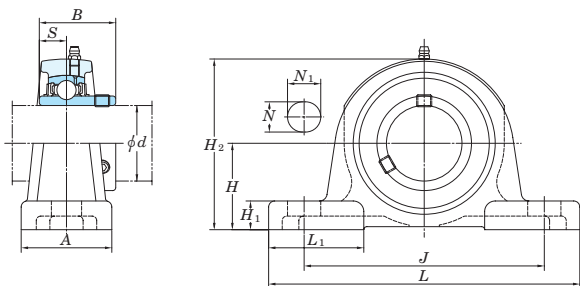

Pressed steel covers

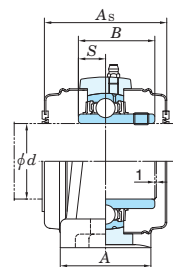

Cast iron covers

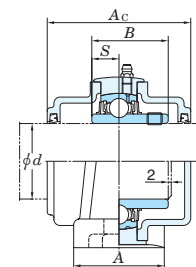

Tolerance for housing

housing No.			unit : mm $\Delta H_s$
P203- P210	PX05- PX10	P305- P310	$\pm 0.15$
P211- P218	PX11- PX18	P311- P318	$\pm 0.2$
	PX20	P319- P328	$\pm 0.3$

$\Delta H_s$  : deviation of distance from mounting base to centre of spherical bearing seating.

Shaft dia. (mm) d	Dimensions (mm)											Bolt size	Unit No.	Housing No.	Applicable bearing			Unit No. with covers				Cover dimensions (mm)		(Refer.) Unit mass (kg)		
	H	L	A	J	N	N <sub>1</sub>	H <sub>1</sub>	H <sub>2</sub>	L <sub>1</sub>	B	S				No.	Basic load ratings (kN)		Factor	Pressed steel covers		Cast iron covers		A <sub>s</sub>	A <sub>c</sub>	Pressed steel covers	Cast iron covers
	C <sub>r</sub>	C <sub>0r</sub>	f <sub>0</sub>	Open ends	Closed end	Open ends	Closed end	—	—																	
55	69.8	260	79	184	25	36	28	139	83	65.1	25.4	M20	UCPX11 UCP311	PX11 P311	UCX11 UC311	52.4	36.2	14.4	UCPX11C	UCPX11CD	—	—	88	—	6.5	—
	80	310	80	236	20	38	27	158	90	66	25	M16				71.6	45.0	13.2	—	—	UCP311C	UCP311CD	—	114	7.9	9.7
60	69.8	241	70	184	20	25	22	138	76	65.1	25.4	M16	UCP212 UCPX12 UCP312	P212 PX12 P312	UC212 UCX12 UC312	52.4	36.2	14.4	UCP212C	UCP212CD	UCP212FC	UCP212FCD	88	114	4.9	6.4
	76.2	286	83	203	25	40	28	152	88	65.1	25.4	M20				57.2	40.1	14.4	UCPX12C	UCPX12CD	—	—	88	—	7.7	—
	85	330	85	250	25	38	29	167	103	71	26	M20				81.9	52.2	13.2	—	—	UCP312C	UCP312CD	—	124	9.5	11.8
65	76.2	265	70	203	25	30	25	150	78	65.1	25.4	M20	UCP213 UCPX13 UCP313	P213 PX13 P313	UC213 UCX13 UC313	57.2	40.1	14.4	UCP213C	UCP213CD	UCP213FC	UCP213FCD	88	114	5.9	7.6
	76.2	286	83	203	25	40	28	155	88	74.6	30.2	M20				62.2	44.1	14.5	UCPX13C	UCPX13CD	—	—	98	—	8.1	—
	90	340	90	260	25	38	32	176	110	75	30	M20				92.7	59.9	13.2	—	—	UCP313C	UCP313CD	—	122	10.7	12.8
70	79.4	266	72	210	25	30	28	156	78	74.6	30.2	M20	UCP214 UCPX14 UCP314	P214 PX14 P314	UC214 UCX14 UC314	62.2	44.1	14.5	UCP214C	UCP214CD	UCP214FC	UCP214FCD	98	124	6.8	8.7
	88.9	330	89	229	27	50	32	171	98	77.8	33.3	M22				67.4	48.3	14.5	UCPX14C	UCPX14CD	—	—	98	—	10.2	—
	95	360	90	280	27	40	35	186	110	78	33	M22				104	68.2	13.2	—	—	UCP314C	UCP314CD	—	124	12.4	14.7
75	82.6	275	74	217	25	30	28	162	80	77.8	33.3	M20	UCP215 UCPX15 UCP315	P215 PX15 P315	UC215 UCX15 UC315	67.4	48.3	14.5	UCP215C	UCP215CD	UCP215FC	UCP215FCD	98	124	7.4	9.3
	88.9	330	89	229	27	50	32	175	99	82.6	33.3	M22				72.7	53.0	14.6	UCPX15C	UCPX15CD	—	—	108	—	10.8	—
	100	380	100	290	27	40	35	198	107	82	32	M22				113	77.2	13.2	—	—	UCP315C	UCP315CD	—	134	14.8	17.3
80	88.9	292	78	232	25	35	32	174	86	82.6	33.3	M20	UCP216 UCPX16 UCP316	P216 PX16 P316	UC216 UCX16 UC316	72.7	53.0	14.6	UCP216C	UCP216CD	UCP216FC	UCP216FCD	108	138	9.0	11.4
	101.6	381	102	283	27	58	34	195	116	85.7	34.1	M22				84.0	61.9	14.5	UCPX16C	UCPX16CD	—	—	112	—	15.3	—
	106	400	110	300	27	40	35	209	120	86	34	M22				123	86.7	13.3	—	—	UCP316C	UCP316CD	—	138	18.5	21.4
85	95.2	310	83	247	25	40	32	185	90	85.7	34.1	M20	UCP217 UCPX17 UCP317	P217 PX17 P317	UC217 UCX17 UC317	84.0	61.9	14.5	UCP217C	UCP217CD	UCP217FC	UCP217FCD	112	142	10.8	13.5
	101.6	381	102	283	27	60	34	200	116	96	39.7	M22				96.1	71.5	14.5	UCPX17C	UCPX17CD	—	—	122	—	16.1	—
	112	420	110	320	33	45	40	220	120	96	40	M27				133	96.8	13.3	—	—	UCP317C	UCP317CD	—	146	20.3	23.6
90	101.6	327	88	262	27	45	34	198	104	96	39.7	M22	UCP218 UCPX18 UCP318	P218 PX18 P318	UC218 UCX18 UC318	96.1	71.5	14.5	UCP218C	UCP218CD	UCP218FC	UCP218FCD	122	152	13.9	17.0
	101.6	381	111	283	27	60	38	204	116	104	42.9	M22				109	81.9	14.4	—	—	UCPX18C	UCPX18CD	—	158	19.1	22.5
	118	430	110	330	33	45	40	234	120	96	40	M27				143	107	13.3	—	—	UCP318C	UCP318CD	—	150	22.8	26.6
95	125	470	120	360	36	50	46	248	125	103	41	M30	UCP319	P319	UC319	153	119	13.3	—	—	UCP319C	UCP319CD	—	162	29.0	33.3

(Remarks) 1) Applicable sizes of grease nipples are shown below.  
A-1/4-28UNF..... 201~210, X05~X09, 305~308  
A-PT 1/8..... 211~218, X10~X20, 309~328

2) For bearings with double- or triple-lip seals, unit and bearing number are suffixed by L2 or L3.  
3) For more detailed information, refer to ball bearing for unit specification tables.



**Ball bearing units  
pillow block type  
UCP (with set screws)**  
*d* 100 ~ 140 mm

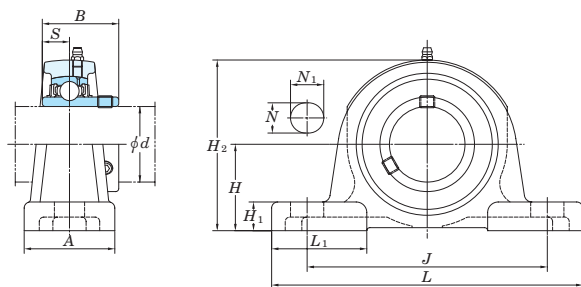

Pressed steel covers

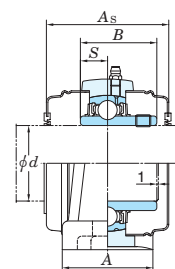

Cast iron covers

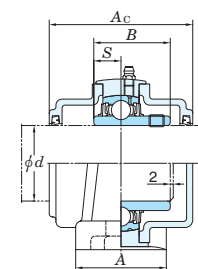

Tolerance for housing

unit : mm

housing No.			$\Delta H_s$
P203~P210	PX05~PX10	P305~P310	$\pm 0.15$
P211~P218	PX11~PX18	P311~P318	$\pm 0.2$
	PX20	P319~P328	$\pm 0.3$

$\Delta H_s$  : deviation of distance from mounting base to centre of spherical bearing seating.

Shaft dia. (mm) <i>d</i>	Dimensions (mm)											Bolt size	Unit No.	Housing No.	Applicable bearing			Unit No. with covers				Cover dimensions (mm)		(Refer.) Unit mass (kg)		
	<i>H</i>	<i>L</i>	<i>A</i>	<i>J</i>	<i>N</i>	<i>N</i> <sub>1</sub>	<i>H</i> <sub>1</sub>	<i>H</i> <sub>2</sub>	<i>L</i> <sub>1</sub>	<i>B</i>	<i>S</i>				No.	Basic load ratings (kN)		Factor	Pressed steel covers		Cast iron covers		<i>A</i> <sub>s</sub>	<i>A</i> <sub>c</sub>	Pressed steel covers	Cast iron covers
	<i>C<sub>r</sub></i>	<i>C<sub>0r</sub></i>	<i>f</i> <sub>0</sub>	Open ends	Closed end	Open ends	Closed end																			
<b>100</b>	127	432	121	337	33	65	45	245	126	117.5	49.2	M27	<b>UCPX20</b>	PX20	UCX20	133	105	14.4	—	—	UCPX20C	UCPX20CD	—	186	30.4	34.9
	140	490	120	380	36	50	46	273	140	108	42	M30	<b>UCP320</b>	P320	UC320	173	141	13.2	—	—	UCP320C	UCP320CD	—	174	35.1	40.7
<b>105</b>	140	490	120	380	36	50	46	278	140	112	44	M30	<b>UCP321</b>	P321	UC321	184	153	13.2	—	—	UCP321C	UCP321CD	—	178	37.6	43.6
<b>110</b>	150	520	140	400	40	55	50	296	150	117	46	M33	<b>UCP322</b>	P322	UC322	205	180	13.2	—	—	UCP322C	UCP322CD	—	188	44.0	50.8
<b>120</b>	160	570	140	450	40	55	50	316	160	126	51	M33	<b>UCP324</b>	P324	UC324	207	185	13.5	—	—	UCP324C	UCP324CD	—	196	55.4	64.9
<b>130</b>	180	600	140	480	40	55	50	355	195	135	54	M33	<b>UCP326</b>	P326	UC326	229	214	13.6	—	—	UCP326C	UCP326CD	—	214	72.1	84.2
<b>140</b>	200	620	140	500	40	55	60	393	185	145	59	M33	<b>UCP328</b>	P328	UC328	253	246	13.6	—	—	UCP328C	UCP328CD	—	222	92.5	108

[Remarks] 1) Applicable sizes of grease nipples are shown below.  
 A-1/4-28UNF ..... 201~210, X05~X09, 305~308  
 A-PT 1/8 ..... 211~218, X10~X20, 309~328

2) For bearings with double- or triple-lip seals, unit and bearing number are suffixed by L2 or L3.  
 3) For more detailed information, refer to ball bearing for unit specification tables.

**Ball bearing units  
pillow block type  
UKP (with adapter)**  
 $d_1$  20 ~ 55 mm

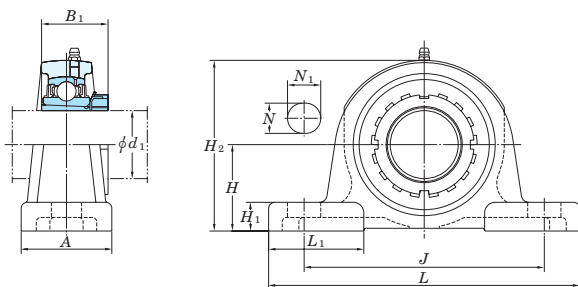

Pressed steel covers

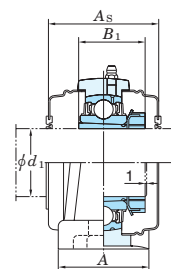

Cast iron covers

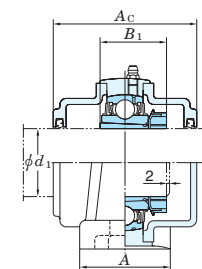

Tolerance for housing

housing No.			unit : mm $\Delta H_s$
P205- P210	PX05- PX10	P305- P310	$\pm 0.15$
P211- P218	PX11- PX18	P311- P318	$\pm 0.2$
	PX20	P319- P328	$\pm 0.3$

$\Delta H_s$ : deviation of distance from mounting base to centre of spherical bearing seating.

P205JE3 (with cast iron covers) are shown below.



Shaft dia. (mm) $d_1$	Dimensions (mm)											Bolt size	Unit No.	Housing No.	Applicable bearing			Applicable <sup>1)</sup> adapter No.	Unit No. with covers				Cover dimensions (mm)		(Refer.) Unit mass (kg)	
	$H$	$L$	$A$	$J$	$N$	$N_1$	$H_1$	$H_2$	$L_1$	$B_1$ <sup>1)</sup>	No.				Basic load ratings (kN)		Factor $f_0$		Pressed steel covers Open ends	Closed end	Cast iron covers Open ends	Closed end	$A_s$	$A_c$	Pressed steel covers	Cast iron covers
															$C_r$	$C_{0r}$										
20	36.5	140	38	105	13	18	13	71	43	29(35)	M10	<b>UKP205</b>	P205	UK205	14.0	7.85	13.9	H305X(H2305X)	UKP205C	UKP205CD	UKP205FC	UKP205FCD	48	66	0.84	1.3
	44.4	159	51	119	17	25	16	86	47	35	M14	<b>UKPX05</b>	PX05	UKX05	19.5	11.3	13.9	H2305X	UKPX05C	UKPX05CD	—	—	52	—	1.5	—
	45	175	45	132	17	20	16	85	55	35	M14	<b>UKP305</b>	P305	UK305	21.2	10.9	12.6	H2305X	—	—	UKP305C	UKP305CD	—	76	1.7	2.3
25	42.9	165	48	121	17	21	15	84	53	31(38)	M14	<b>UKP206</b>	P206	UK206	19.5	11.3	13.9	H306X(H2306X)	UKP206C	UKP206CD	UKP206FC	UKP206FCD	52	70	1.4	1.9
	47.6	175	57	127	17	25	17	93	55	38	M14	<b>UKPX06</b>	PX06	UKX06	25.7	15.4	13.9	H2306X	UKPX06C	UKPX06CD	—	—	59	—	2.1	—
	50	180	50	140	17	20	17	95	53	38	M14	<b>UKP306</b>	P306	UK306	26.7	15.0	13.3	H2306X	—	—	UKP306C	UKP306CD	—	82	2.3	2.9
30	47.6	167	48	127	17	21	16	93	51	35(43)	M14	<b>UKP207</b>	P207	UK207	25.7	15.4	13.9	H307X(H2307X)	UKP207C	UKP207CD	UKP207FC	UKP207FCD	59	78	1.7	2.5
	54	203	57	144	17	30	19	105	64	43	M14	<b>UKPX07</b>	PX07	UKX07	29.1	17.8	14.0	H2307X	UKPX07C	UKPX07CD	—	—	68	—	2.7	—
	56	210	56	160	17	25	19	107	65	43	M14	<b>UKP307</b>	P307	UK307	33.4	19.3	13.2	H2307X	—	—	UKP307C	UKP307CD	—	88	3.0	3.9
35	49.2	184	54	137	17	21	17	98	57	36(46)	M14	<b>UKP208</b>	P208	UK208	29.1	17.8	14.0	H308X(H2308X)	UKP208C	UKP208CD	UKP208FC	UKP208FCD	68	86	2.0	2.9
	58.7	222	67	156	20	32	21	114	71	46	M16	<b>UKPX08</b>	PX08	UKX08	32.7	20.3	14.0	H2308X	UKPX08C	UKPX08CD	—	—	68	—	3.5	—
	60	220	60	170	17	27	19	118	65	46	M14	<b>UKP308</b>	P308	UK308	40.7	24.0	13.2	H2308X	—	—	UKP308C	UKP308CD	—	96	3.8	5.2
40	54	190	54	146	17	21	17	106	60	39(50)	M14	<b>UKP209</b>	P209	UK209	32.7	20.3	14.0	H309X(H2309X)	UKP209C	UKP209CD	UKP209FC	UKP209FCD	68	88	2.3	3.2
	58.7	222	67	156	20	33	21	116	71	50	M16	<b>UKPX09</b>	PX09	UKX09	35.1	23.3	14.4	H2309X	UKPX09C	UKPX09CD	—	—	73	—	3.7	—
	67	245	67	190	20	30	21	132	75	50	M16	<b>UKP309</b>	P309	UK309	48.9	29.5	13.3	H2309X	—	—	UKP309C	UKP309CD	—	102	5.0	6.3
45	57.2	206	60	159	20	22	19	113	63	42(55)	M16	<b>UKP210</b>	P210	UK210	35.1	23.3	14.4	H310X(H2310X)	UKP210C	UKP210CD	UKP210FC	UKP210FCD	73	97	3.0	4.1
	63.5	241	73	171	20	36	22	126	76	55	M16	<b>UKPX10</b>	PX10	UKX10	43.4	29.4	14.4	H2310X	UKPX10C	UKPX10CD	—	—	75	—	4.6	—
	75	275	75	212	20	35	24	148	88	55	M16	<b>UKP310</b>	P310	UK310	62.0	38.3	13.2	H2310X	—	—	UKP310C	UKP310CD	—	110	6.7	8.4
50	63.5	219	60	171	20	22	19	125	70	45(59)	M16	<b>UKP211</b>	P211	UK211	43.4	29.4	14.4	H311X(H2311X)	UKP211C	UKP211CD	UKP211FC	UKP211FCD	75	99	3.7	5.0
	69.8	260	79	184	25	36	28	139	83	59	M20	<b>UKPX11</b>	PX11	UKX11	52.4	36.2	14.4	H2311X	UKPX11C	UKPX11CD	—	—	88	—	6.2	—
	80	310	80	236	20	38	27	158	90	59	M16	<b>UKP311</b>	P311	UK311	71.6	45.0	13.2	H2311X	—	—	UKP311C	UKP311CD	—	114	8.1	10.0
55	69.8	241	70	184	20	25	22	138	76	47(62)	M16	<b>UKP212</b>	P212	UK212	52.4	36.2	14.4	H312X(H2312X)	UKP212C	UKP212CD	UKP212FC	UKP212FCD	88	114	4.8	6.3
	76.2	286	83	203	25	40	28	152	88	62	M20	<b>UKPX12</b>	PX12	UKX12	57.2	40.1	14.4	H2312X	UKPX12C	UKPX12CD	—	—	88	—	7.5	—
	85	330	85	250	25	38	29	167	103	62	M20	<b>UKP312</b>	P312	UK312	81.9	52.2	13.2	H2312X	—	—	UKP312C	UKP312CD	—	124	9.4	11.8

[Note] 1) ( ) Shown for use triple lip seal bearing and applicable adapter No.(H2300X series).

[Remarks] 1) Applicable sizes of grease nipples are shown below.

A-1/4-28UNF ..... 205~210, X05~X09, 305~308  
A-PT 1/8 ..... 211~218, X10~X20, 309~328

2) Unit No. means housing and bearing assembly, whole complete unit No. is given follows.

(UKP206+H306X, UK206+H306X)

3) For bearings with double- or triple-lip seals, unit and bearing number are suffixed by L2 or L3.

(UKP206JL3+H2306X, UK206L3+H2306X)

4) For more detailed information, refer to ball bearing for unit specification tables. Not applied to UKX series.

**Ball bearing units  
pillow block type  
UKP (with adapter)**  
 $d_1$  60 ~ 125 mm

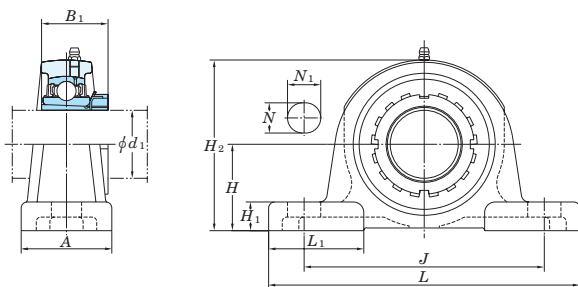

Pressed steel covers

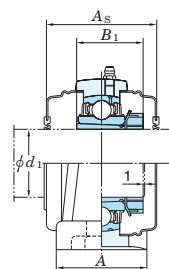

Cast iron covers

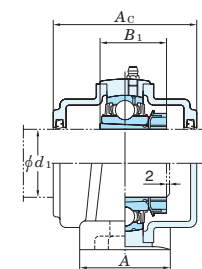

Tolerance for housing

housing No.			unit : mm
			$\Delta H_s$
P205~P210	PX05~PX10	P305~P310	$\pm 0.15$
P211~P218	PX11~PX18	P311~P318	$\pm 0.2$
	PX20	P319~P328	$\pm 0.3$

$\Delta H_s$  : deviation of distance from mounting base to centre of spherical bearing seating.

Shaft dia. (mm) $d_1$	Dimensions (mm)										Bolt size	Unit No.	Housing No.	Applicable bearing			Applicable <sup>1)</sup> adapter No.	Unit No. with covers				Cover dimensions (mm)		(Refer.) Unit mass (kg)		
	H	L	A	J	N	N <sub>1</sub>	H <sub>1</sub>	H <sub>2</sub>	L <sub>1</sub>	B <sub>1</sub> <sup>1)</sup>				No.	Basic load ratings (kN)			Factor $f_0$	Pressed steel covers		Cast iron covers		A <sub>s</sub>	A <sub>c</sub>	Pressed steel covers	Cast iron covers
															$C_r$	$C_{0r}$			Open ends	Closed end	Open ends	Closed end				
60	76.2	265	70	203	25	30	25	150	78	50(65)	M20	UKP213	P213	UK213	57.2	40.1	14.4	H313X(H2313X)	UKP213C	UKP213CD	UKP213FC	UKP213FCD	88	114	5.8	7.5
	76.2	286	83	203	25	40	28	155	88	65	M20	UKPX13	PX13	UKX13	62.2	44.1	14.5	H2313X	UKPX13C	UKPX13CD	—	—	98	—	7.8	—
	90	340	90	260	25	38	32	176	110	65	M20	UKP313	P313	UK313	92.7	59.9	13.2	H2313X	—	—	UKP313C	UKP313CD	—	122	10.8	13.2
65	82.6	275	74	217	25	30	28	162	80	55(73)	M20	UKP215	P215	UK215	67.4	48.3	14.5	H315X(H2315X)	UKP215C	UKP215CD	UKP215FC	UKP215FCD	98	124	7.5	9.5
	88.9	330	89	229	27	50	32	175	99	73	M22	UKPX15	PX15	UKX15	72.7	53.0	14.6	H2315X	UKPX15C	UKPX15CD	—	—	108	—	10.5	—
	100	380	100	290	27	40	35	198	107	73	M22	UKP315	P315	UK315	113	77.2	13.2	H2315X	—	—	UKP315C	UKP315CD	—	134	14.9	17.7
70	88.9	292	78	232	25	35	32	174	86	59(78)	M20	UKP216	P216	UK216	72.7	53.0	14.6	H316X(H2316X)	UKP216C	UKP216CD	UKP216FC	UKP216FCD	108	138	9.2	11.7
	101.6	381	102	283	27	58	34	195	116	78	M22	UKPX16	PX16	UKX16	84.0	61.9	14.5	H2316X	UKPX16C	UKPX16CD	—	—	112	—	15.4	—
	106	400	110	300	27	40	35	209	120	78	M22	UKP316	P316	UK316	123	86.7	13.3	H2316X	—	—	UKP316C	UKP316CD	—	138	18.6	21.7
75	95.2	310	83	247	25	40	32	185	90	63(82)	M20	UKP217	P217	UK217	84.0	61.9	14.5	H317X(H2317X)	UKP217C	UKP217CD	UKP217FC	UKP217FCD	112	142	11.0	13.8
	101.6	381	102	283	27	60	34	200	116	82	M22	UKPX17	PX17	UKX17	96.1	71.5	14.5	H2317X	UKPX17C	UKPX17CD	—	—	122	—	15.8	—
	112	420	110	320	33	45	40	220	120	82	M27	UKP317	P317	UK317	133	96.8	13.3	H2317X	—	—	UKP317C	UKP317CD	—	146	20.2	23.7
80	101.6	327	88	262	27	45	34	198	104	65(86)	M22	UKP218	P218	UK218	96.1	71.5	14.5	H318X(H2318X)	UKP218C	UKP218CD	UKP218FC	UKP218FCD	122	152	13.8	18.8
	101.6	381	111	283	27	60	38	204	116	86	M22	UKPX18	PX18	UKX18	109	81.9	14.4	H2318X	—	—	UKP318C	UKP318CD	—	158	18.6	22.4
	118	430	110	330	33	45	40	234	120	86	M27	UKP318	P318	UK318	143	107	13.3	H2318X	—	—	UKP318C	UKP318CD	—	150	22.8	27.0
85	125	470	120	360	36	50	46	248	125	90	M30	UKP319	P319	UK319	153	119	13.3	H2319X	—	—	UKP319C	UKP319CD	—	162	29.3	34.0
90	127	432	121	337	33	65	45	245	126	97	M27	UKPX20	PX20	UKX20	133	105	14.4	H2320X	—	—	UKP320C	UKP320CD	—	186	29.3	34.3
	140	490	120	380	36	50	46	273	140	97	M30	UKP320	P320	UK320	173	141	13.2	H2320X	—	—	UKP320C	UKP320CD	—	174	34.8	41.0
100	150	520	140	400	40	55	50	296	150	105	M33	UKP322	P322	UK322	205	180	13.2	H2322X	—	—	UKP322C	UKP322CD	—	188	43.9	50.8
110	160	570	140	450	40	55	50	316	160	112	M33	UKP324	P324	UK324	207	185	13.5	H2324	—	—	UKP324C	UKP324CD	—	196	55.7	66.0
115	180	600	140	480	40	55	50	355	195	121	M33	UKP326	P326	UK326	229	214	13.6	H2326	—	—	UKP326C	UKP326CD	—	214	71.9	85.2
125	200	620	140	500	40	55	60	393	185	131	M33	UKP328	P328	UK328	253	246	13.6	H2328	—	—	UKP328C	UKP328CD	—	222	92.5	109

[Note] 1) ( ) Shown for use triple lip seal bearing and applicable adapter No.(H2300X series).

[Remarks] 1) Applicable sizes of grease nipples are shown below.

A-1/4-28UNF..... 205~210, X05~X09, 305~308  
A-PT 1/8..... 211~218, X10~X20, 309~328

2) Unit No. means housing and bearing assembly, whole complete unit No. is given follows.  
(UKP206+H306X, UK206+H306X)

3) For bearings with double- or triple-lip seals, unit and bearing number are suffixed by L2 or L3.  
(UKP206JL3+H2306X, UK206L3+H2306X)

4) For more detailed information, refer to ball bearing for unit specification tables. Not applied to UKX series.

**Ball bearing units**  
**thick section pillow block type**  
**UCIP (with set screws)**

*d* 40 ~ 140 mm

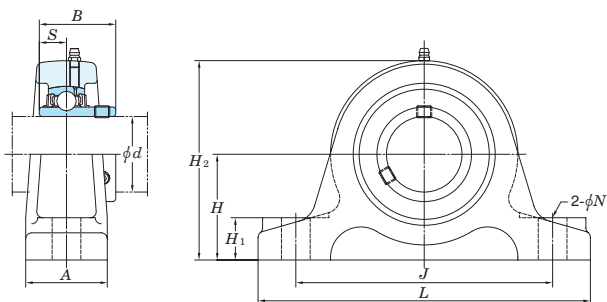

Pressed steel covers

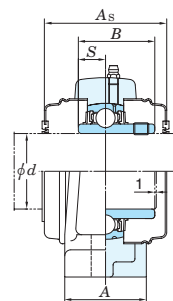

Cast iron covers

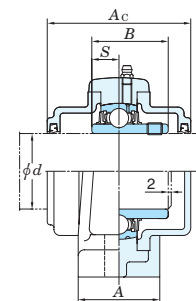

Tolerances for housing

unit : mm

housing No.	$\Delta H_s$	X
IP208~IP210	$\pm 0.15$	1
IP211~IP213	$\pm 0.2$	1.4
IP313~IP318	$\pm 0.2$	
IP319~IP328	$\pm 0.3$	

$\Delta H_s$  : deviation of distance from mounting base to centre of spherical bearing seating.  
 X : positional tolerance of bolt hole.

Shaft dia. (mm) <i>d</i>	Dimensions (mm)										Bolt size	Unit No.	Housing No.	Applicable bearing			Unit No. with covers				Cover dimensions (mm)		(Refer.) Unit mass (kg)	
	<i>H</i>	<i>L</i>	<i>A</i>	<i>J</i>	<i>N</i>	<i>H</i> <sub>1</sub>	<i>H</i> <sub>2</sub>	<i>B</i>	<i>S</i>	No.				Basic load ratings (kN)		Factor	Pressed steel covers		Cast iron covers		<i>A</i> <sub>s</sub>	<i>A</i> <sub>c</sub>	Pressed steel covers	Cast iron covers
	<i>C<sub>r</sub></i>	<i>C<sub>0r</sub></i>	<i>f</i> <sub>0</sub>	Open ends	Closed end	Open ends	Closed end																	
40	60	200	60	150	19	25	115	49.2	19	M16	UCIP208	IP208	UC208	29.1	17.8	14.0	UCIP208C	UCIP208CD	UCIP208FC	UCIP208FCD	68	86	3.4	4.2
45	70	210	60	160	19	25	128	49.2	19	M16	UCIP209	IP209	UC209	32.7	20.3	14.0	UCIP209C	UCIP209CD	UCIP209FC	UCIP209FCD	68	88	3.9	4.7
50	70	220	60	170	19	28	132	51.6	19	M16	UCIP210	IP210	UC210	35.1	23.3	14.4	UCIP210C	UCIP210CD	UCIP210FC	UCIP210FCD	73	97	4.8	5.8
55	80	230	60	180	19	28	148	55.6	22.2	M16	UCIP211	IP211	UC211	43.4	29.4	14.4	UCIP211C	UCIP211CD	UCIP211FC	UCIP211FCD	75	99	5.3	6.3
60	80	260	70	200	22	30	155	65.1	25.4	M20	UCIP212	IP212	UC212	52.4	36.2	14.4	UCIP212C	UCIP212CD	UCIP212FC	UCIP212FCD	88	114	7.2	8.7
65	90	280	70	220	22	30	172	65.1	25.4	M20	UCIP213	IP213	UC213	57.2	40.1	14.4	UCIP213C	UCIP213CD	UCIP213FC	UCIP213FCD	88	114	8.8	10.5
	110	310	70	250	22	30	208	75	30	M20	UCIP313	IP313	UC313	92.7	59.9	13.2	—	—	UCIP313C	UCIP313CD	—	122	13.4	15.5
70	110	330	75	270	25	35	215	78	33	M22	UCIP314	IP314	UC314	104	68.2	13.2	—	—	UCIP314C	UCIP314CD	—	124	15.3	17.6
75	120	340	75	280	25	35	230	82	32	M22	UCIP315	IP315	UC315	113	77.2	13.2	—	—	UCIP315C	UCIP315CD	—	134	17.6	20.1
80	120	350	85	290	25	40	235	86	34	M22	UCIP316	IP316	UC316	123	86.7	13.3	—	—	UCIP316C	UCIP316CD	—	138	20.3	23.2
85	130	370	85	310	25	40	255	96	40	M22	UCIP317	IP317	UC317	133	96.8	13.3	—	—	UCIP317C	UCIP317CD	—	146	25.9	29.2
90	130	400	85	330	29	45	260	96	40	M27	UCIP318	IP318	UC318	143	107	13.3	—	—	UCIP318C	UCIP318CD	—	150	28.6	32.4
95	150	410	85	340	29	45	285	103	41	M27	UCIP319	IP319	UC319	153	119	13.3	—	—	UCIP319C	UCIP319CD	—	162	31.7	36.0
100	150	430	85	360	29	45	295	108	42	M27	UCIP320	IP320	UC320	173	141	13.2	—	—	UCIP320C	UCIP320CD	—	174	36.9	42.5
110	170	490	100	410	32	50	335	117	46	M30	UCIP322	IP322	UC322	205	180	13.2	—	—	UCIP322C	UCIP322CD	—	188	52.4	59.2
120	170	510	100	430	32	50	345	126	51	M30	UCIP324	IP324	UC324	207	185	13.5	—	—	UCIP324C	UCIP324CD	—	196	58.7	68.2
130	200	550	110	470	32	50	390	135	54	M30	UCIP326	IP326	UC326	229	214	13.6	—	—	UCIP326C	UCIP326CD	—	214	76.2	88.3
140	200	590	110	500	35	55	400	145	59	M33	UCIP328	IP328	UC328	253	246	13.6	—	—	UCIP328C	UCIP328CD	—	222	87.0	102

(Remarks) 1) Applicable sizes of grease nipples are shown below.  
 A-1/4-28UNF ..... 208~210  
 A-PT 1/8 ..... 211~213, 313~328

2) Bearings with triple-lip seals are indicated by L3 after the bearing and unit number.  
 (UCIP208JL3, UC208L3)  
 3) For more detailed information, refer to ball bearing for unit specification tables.

**Ball bearing units**  
**light duty pillow block type**  
**BLP (with set screws)**  
*d* 12 ~ 40 mm

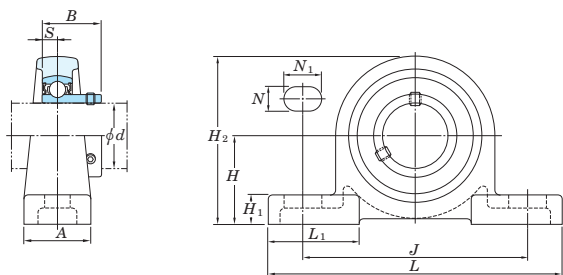

Shaft dia. (mm)	Dimensions (mm)											Bolt size	Unit No.	Housing No.	No.	Applicable bearing			(Refer.) Unit mass (kg)
	<i>H</i> ±0.15	<i>L</i>	<i>A</i>	<i>J</i>	<i>N</i>	<i>N</i> <sub>1</sub>	<i>H</i> <sub>1</sub>	<i>H</i> <sub>2</sub>	<i>L</i> <sub>1</sub>	<i>B</i>	<i>S</i>					Basic load ratings (kN)	Factor	<i>C</i> <sub>r</sub>	
<b>12</b>	30.2	114	25	87	11	16	12	57	35	22	6	M10	<b>BLP201</b>	LP203	SB201	9.55	4.80	13.2	0.36
<b>15</b>	30.2	114	25	87	11	16	12	57	35	22	6	M10	<b>BLP202</b>	LP203	SB202	9.55	4.80	13.2	0.36
<b>17</b>	30.2	114	25	87	11	16	12	57	35	22	6	M10	<b>BLP203</b>	LP203	SB203	9.55	4.80	13.2	0.36
<b>20</b>	33.3	125	27	97	11	16	13	65	38	25	7	M10	<b>BLP204</b>	LP204	SB204	12.8	6.65	13.2	0.51
<b>25</b>	36.5	130	29	100	11	16	13	71	39	27	7.5	M10	<b>BLP205</b>	LP205	SB205	14.0	7.85	13.9	0.57
<b>30</b>	42.9	156	33	120	14	21	14	83	47	30	8	M12	<b>BLP206</b>	LP206	SB206	19.5	11.3	13.9	0.69
<b>35</b>	47.6	165	35	127	14	21	16	93	50	32	8.5	M12	<b>BLP207</b>	LP207	SB207	25.7	15.4	13.9	0.94
<b>40</b>	50.8	184	37	140	14	22	18	102	55	34	9	M12	<b>BLP208</b>	LP208	SB208	29.1	17.8	14.0	1.8

[Remarks] 1) The radial loading on housing should not exceed 50% of the basic load rating (*C<sub>r</sub>*).  
 2) For more detailed information, refer to ball bearing for unit specification tables.

**Ball bearing units**  
**“compact” series pillow block type**

**UP (with set screws)**

*d* 10 ~ 30 mm

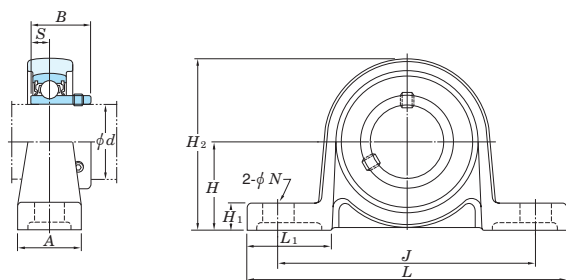

Open ends type

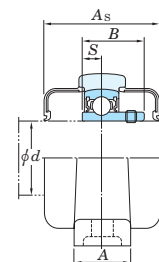

Closed end type

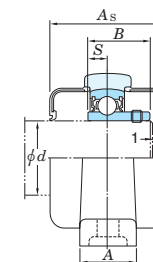

Tolerance for housing

unit : mm	
housing No.	X
P000-P006	0.6

X : positional tolerance of bolt hole.

Shaft dia. (mm) <i>d</i>	Dimensions (mm)										Bolt size	Unit No.	Housing No.	No.	Applicable bearing			Unit No. with covers		Cover dimension (mm) <i>A<sub>s</sub></i>	(Refer.) Unit mass (kg)
	<i>H</i> ±0.15	<i>L</i>	<i>A</i>	<i>J</i>	<i>N</i> ±0.2	<i>H</i> <sub>1</sub>	<i>H</i> <sub>2</sub>	<i>L</i> <sub>1</sub>	<i>B</i>	<i>S</i>					Basic load ratings (kN)	Factor	Open ends	Closed end			
													<i>C<sub>r</sub></i>	<i>C<sub>0r</sub></i>	<i>f</i> <sub>0</sub>						
10	18	67	16	53	7	6	35	18	15	5	M6	UP000	P000	SU000	4.55	1.95	12.3	UP000C	UP000CD	29	0.070
12	19	71	16	56	7	6	38	19	15	5	M6	UP001	P001	SU001	5.10	2.40	13.2	UP001C	UP001CD	29	0.090
15	22	80	16	63	7	7	43	21	16.5	5.5	M6	UP002	P002	SU002	5.60	2.85	13.9	UP002C	UP002CD	31	0.11
17	24	85	18	67	7	7	47	21	17.5	6	M6	UP003	P003	SU003	6.00	3.25	14.4	UP003C	UP003CD	33	0.15
20	28	100	20	80	10	9	55	25	21	7	M8	UP004	P004	SU004	9.40	5.05	13.9	UP004C	UP004CD	38	0.23
25	32	112	20	90	10	10	62	28	22	7	M8	UP005	P005	SU005	10.1	5.85	14.5	UP005C	UP005CD	40	0.28
30	36	132	26	106	13	11	70	34	24.5	7.5	M10	UP006	P006	SU006	13.2	8.25	14.7	UP006C	UP006CD	44	0.42

- [Remarks] 1) Housing is made from special light alloy.  
 2) For more detailed information, refer to ball bearing for unit specification tables.

**Ball bearing units**  
**stainless-series pillow block type**  
**UCSP-H1S6 (with set screws)**

*d* 12 ~ 50 mm

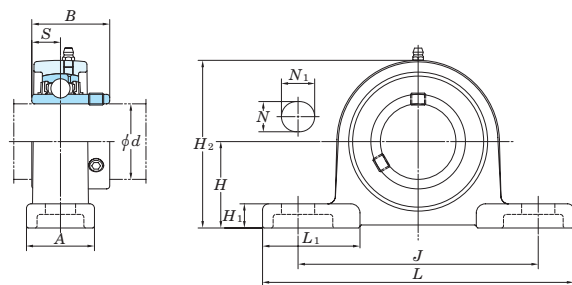

Pressed stainless steel covers

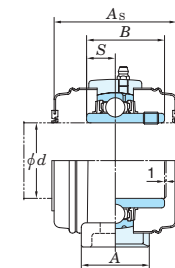

Shaft dia. (mm) <i>d</i>	Dimensions (mm)											Bolt size	Unit No.	Housing No.	No.	Applicable bearing			Unit No. with covers		Cover dimension (mm) <i>A<sub>s</sub></i>	(Refer.) Unit mass (kg) Pressed steel covers
	<i>H</i> ±0.15	<i>L</i>	<i>A</i>	<i>J</i>	<i>N</i>	<i>N<sub>1</sub></i>	<i>H<sub>1</sub></i>	<i>H<sub>2</sub></i>	<i>L<sub>1</sub></i>	<i>B</i>	<i>S</i>					Basic load ratings (kN) <i>C<sub>r</sub></i> <i>C<sub>0r</sub></i>	Factor <i>f<sub>0</sub></i>	Open ends	Closed end			
12	30.2	127	30	95	13	18	11	56	42	27.4	11.5	M10	UCSP201XH1S6	SP203H1	UC201XS6	8.15	3.85	13.2	—	—	—	0.42
15	30.2	127	30	95	13	18	11	56	42	27.4	11.5	M10	UCSP202XH1S6	SP203H1	UC202XS6	8.15	3.85	13.2	—	—	—	0.42
17	30.2	127	30	95	13	18	11	56	42	27.4	11.5	M10	UCSP203XH1S6	SP203H1	UC203XS6	8.15	3.85	13.2	—	—	—	0.42
20	33.3	127	30	95	13	18	11	63	42	31	12.7	M10	UCSP204H1S6	SP204H1	UC204S6	10.9	5.35	13.2	UCSP204H1CS6	UCSP204H1CDS6	45	0.54
25	36.5	140	30	105	13	19	12	69	46	34.1	14.3	M10	UCSP205H1S6	SP205H1	UC205S6	11.9	6.30	13.9	UCSP205H1CS6	UCSP205H1CDS6	49	0.70
30	42.9	165	36	121	17	21	13	81	54	38.1	15.9	M14	UCSP206H1S6	SP206H1	UC206S6	16.5	9.05	13.9	UCSP206H1CS6	UCSP206H1CDS6	53	1.0
35	47.6	167	38	127	17	21	14	91	51	42.9	17.5	M14	UCSP207H1S6	SP207H1	UC207S6	21.8	12.3	13.9	UCSP207H1CS6	UCSP207H1CDS6	60	1.4
40	49.2	184	40	137	17	21	14	97	60	49.2	19	M14	UCSP208H1S6	SP208H1	UC208S6	24.8	14.3	14.0	UCSP208H1CS6	UCSP208H1CDS6	69	1.7
45	54	190	40	146	17	21	15	104	61	49.2	19	M14	UCSP209H1S6	SP209H1	UC209S6	27.8	16.2	14.0	UCSP209H1CS6	UCSP209H1CDS6	69	1.8
50	57.2	206	45	159	20	22	16	111	65	51.6	19	M16	UCSP210H1S6	SP210H1	UC210S6	29.8	18.6	14.4	UCSP210H1CS6	UCSP210H1CDS6	74	2.3

[Remarks] 1) Applicable size of grease nipples is A-1/4-28UNF.

2) For more detailed information, refer to ball bearing for unit specification tables.

**Ball bearing units**  
**pressed steel pillow block type**  
**SBPP**

$d$  12 ~ 35 mm

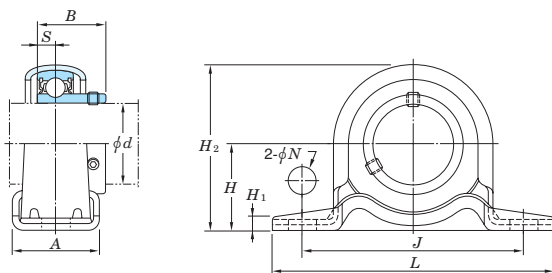

Shaft dia. (mm)	Dimensions (mm)									Bolt size	Unit No.	Housing No.	No.	Applicable bearing			(Refer.) Unit mass (kg)
	$H$	$L$	$A$	$J$ $\pm 0.4$	$N$ $\pm 0.5$	$H_1$	$H_2$	$B$	$S$					Basic load ratings (kN)	Factor	$C_r$	
<b>12</b>	22.2	86	25	68	9.5	3.2	43.8	22	6	M8	<b>SBPP201</b>	PP203F	SB201	9.55	4.80	13.2	0.16
<b>15</b>	22.2	86	25	68	9.5	3.2	43.8	22	6	M8	<b>SBPP202</b>	PP203F	SB202	9.55	4.80	13.2	0.16
<b>17</b>	22.2	86	25	68	9.5	3.2	43.8	22	6	M8	<b>SBPP203</b>	PP203F	SB203	9.55	4.80	13.2	0.16
<b>20</b>	25.4	98	32	76	9.5	3.2	50.5	25	7	M8	<b>SBPP204</b>	PP204F	SB204	12.8	6.65	13.2	0.23
<b>25</b>	28.6	108	32	86	11.5	4	56.6	27	7.5	M10	<b>SBPP205</b>	PP205F	SB205	14.0	7.85	13.9	0.28
<b>30</b>	33.3	117	38	95	11.5	4	66.3	30	8	M10	<b>SBPP206</b>	PP206F	SB206	19.5	11.3	13.9	0.47
<b>35</b>	39.7	129	41	106	11.5	4.6	78	32	8.5	M10	<b>SBPP207</b>	PP207F	SB207	25.7	15.4	13.9	0.67

[Remark] 1) For more detailed information, refer to ball bearing for unit specification tables.



**Ball bearing units  
square-flanged type  
UCF (with set screws)**

*d* 12 ~ (55) mm

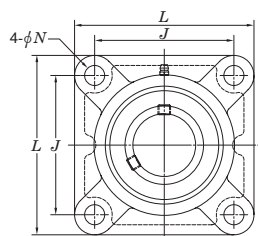
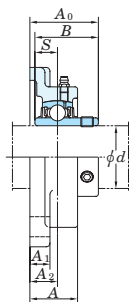

Pressed steel cover

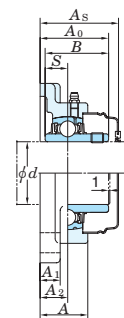

Cast iron cover

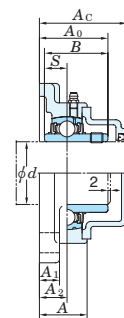

Tolerances for housing

unit : mm

housing No.			$\Delta A_{2s}$	X
F204- F210	FX05- FX10	F305- F310	$\pm 0.5$	0.7
F211- F218	FX11- FX20	F311- F328	$\pm 0.8$	1

$\Delta A_{2s}$  : deviation of distance from mounting face to centre of spherical bearing seating.

X : positional tolerance of bolt hole.

unit : mm

housing No.			$\Delta N_s$
F204- F218	FX05- FX18	F305- F315	$\pm 0.2$
	FX20	F316- F328	$\pm 0.3$

$\Delta N_s$  : deviation of bolt hole diameter.

Shaft dia. (mm) <i>d</i>	Dimensions (mm)										Bolt size	Unit No.	Housing No.	Applicable bearing			Unit No. with covers				Cover dimensions (mm)		(Refer.) Unit mass (kg)			
	<i>L</i>	<i>A</i>	<i>J</i>	<i>N</i>	<i>A</i> <sub>1</sub>	<i>A</i> <sub>2</sub>	<i>A</i> <sub>0</sub>	<i>B</i>	<i>S</i>	No.				Basic load ratings (kN)		Factor <i>f</i> <sub>0</sub>	Pressed steel covers		Cast iron covers		<i>A</i> <sub>s</sub>	<i>A</i> <sub>c</sub>	Pressed steel covers	Cast iron covers		
														<i>C</i> <sub>r</sub>	<i>C</i> <sub>0r</sub>		Open ends	Closed end	Open ends	Closed end						
<b>12</b>	86	25.5	64	12	11	15	33.3	31	12.7	M10	<b>UCF201</b>	F204		UC201	12.8	6.65	13.2	UCF201C	UCF201D	—	—	37	—	0.64	—	
	<b>15</b>	86	25.5	64	12	11	15	33.3	31	12.7	M10	<b>UCF202</b>	F204		UC202	12.8	6.65	13.2	UCF202C	UCF202D	—	—	37	—	0.62	—
		<b>17</b>	86	25.5	64	12	11	15	33.3	31	12.7	M10	<b>UCF203</b>	F204		UC203	12.8	6.65	13.2	UCF203C	UCF203D	—	—	37	—	0.61
<b>20</b>	86	25.5	64	12	11	15	33.3	31	12.7	M10	<b>UCF204</b>	F204		UC204	12.8	6.65	13.2	UCF204C	UCF204D	UCF204FC	UCF204FD	37	46	0.59	0.74	
	<b>25</b>	95	27	70	12	13	16	35.8	34.1	14.3	M10	<b>UCF205</b>	F205		UC205	14.0	7.85	13.9	UCF205C	UCF205D	UCF205FC	UCF205FD	40	49	0.83	1.0
		108	30	83	12	13	18	40.2	38.1	15.9	M10	<b>UCFX05</b>	FX05		UCX05	19.5	11.3	13.9	UCFX05C	UCFX05D	—	—	44	—	1.2	—
	110	29	80	16	13	16	39	38	15	M14	<b>UCF305</b>	F305		UC305	21.2	10.9	12.6	—	—	UCF305C	UCF305D	—	54	1.3	1.6	
<b>30</b>	108	31	83	12	13	18	40.2	38.1	15.9	M10	<b>UCF206</b>	F206		UC206	19.5	11.3	13.9	UCF206C	UCF206D	UCF206FC	UCF206FD	44	53	1.1	1.4	
	117	34	92	16	14	19	44.4	42.9	17.5	M14	<b>UCFX06</b>	FX06		UCX06	25.7	15.4	13.9	UCFX06C	UCFX06D	—	—	49	—	1.6	—	
	125	32	95	16	15	18	44	43	17	M14	<b>UCF306</b>	F306		UC306	26.7	15.0	13.3	—	—	UCF306C	UCF306D	—	59	1.9	2.2	
<b>35</b>	117	34	92	14	15	19	44.4	42.9	17.5	M12	<b>UCF207</b>	F207		UC207	25.7	15.4	13.9	UCF207C	UCF207D	UCF207FC	UCF207FD	49	58	1.5	1.9	
	130	38	102	16	14	21	51.2	49.2	19	M14	<b>UCFX07</b>	FX07		UCX07	29.1	17.8	14.0	UCFX07C	UCFX07D	—	—	55	—	2.0	—	
	135	36	100	19	16	20	49	48	19	M16	<b>UCF307</b>	F307		UC307	33.4	19.3	13.2	—	—	UCF307C	UCF307D	—	64	2.3	2.7	
<b>40</b>	130	36	102	16	15	21	51.2	49.2	19	M14	<b>UCF208</b>	F208		UC208	29.1	17.8	14.0	UCF208C	UCF208D	UCF208FC	UCF208FD	55	64	1.9	2.3	
	137	40	105	19	14	22	52.2	49.2	19	M16	<b>UCFX08</b>	FX08		UCX08	32.7	20.3	14.0	UCFX08C	UCFX08D	—	—	56	—	2.4	—	
	150	40	112	19	17	23	56	52	19	M16	<b>UCF308</b>	F308		UC308	40.7	24.0	13.2	—	—	UCF308C	UCF308D	—	71	3.1	3.6	
<b>45</b>	137	38	105	16	16	22	52.2	49.2	19	M14	<b>UCF209</b>	F209		UC209	32.7	20.3	14.0	UCF209C	UCF209D	UCF209FC	UCF209FD	56	66	2.2	2.6	
	143	40	111	19	14	23	55.6	51.6	19	M16	<b>UCFX09</b>	FX09		UCX09	35.1	23.3	14.4	UCFX09C	UCFX09D	—	—	60	—	2.7	—	
	160	44	125	19	18	25	60	57	22	M16	<b>UCF309</b>	F309		UC309	48.9	29.5	13.3	—	—	UCF309C	UCF309D	—	76	4.0	4.6	
<b>50</b>	143	40	111	16	16	22	54.6	51.6	19	M14	<b>UCF210</b>	F210		UC210	35.1	23.3	14.4	UCF210C	UCF210D	UCF210FC	UCF210FD	59	70.5	2.5	3.0	
	162	44	130	19	20	26	59.4	55.6	22.2	M16	<b>UCFX10</b>	FX10		UCX10	43.4	29.4	14.4	UCFX10C	UCFX10D	—	—	64	—	3.7	—	
	175	48	132	23	19	28	67	61	22	M20	<b>UCF310</b>	F310		UC310	62.0	38.3	13.2	—	—	UCF310C	UCF310D	—	83	5.1	5.9	
<b>55</b>	162	43	130	19	18	25	58.4	55.6	22.2	M16	<b>UCF211</b>	F211		UC211	43.4	29.4	14.4	UCF211C	UCF211D	UCF211FC	UCF211FD	63	74.5	3.4	4.0	

[Remarks] 1) Applicable sizes of grease nipples are shown below.  
 A-1/4-28UNF ..... 201~210, X05~X09, 305~308  
 A-PT 1/8 ..... 211~218, X10~X20, 309~328

2) For bearings with double- or triple-lip seals, unit and bearing number are suffixed by L2 or L3.  
 (UCF206JL3, UC206L3)

3) For more detailed information, refer to ball bearing for unit specification tables.

**Ball bearing units**  
**square-flanged type**  
**UCF (with set screws)**

*d* (55) ~ 95 mm

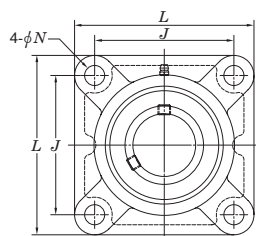
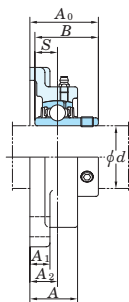

Pressed steel cover

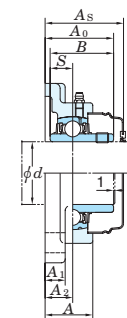

Cast iron cover

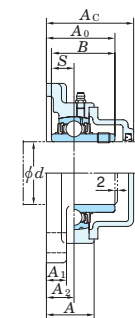

Tolerances for housing

unit : mm

housing No.			$\Delta A_{2s}$	X
F204- F210	FX05- FX10	F305- F310	$\pm 0.5$	0.7
F211- F218	FX11- FX20	F311- F328	$\pm 0.8$	1

$\Delta A_{2s}$  : deviation of distance from mounting face to centre of spherical bearing seating.

X : positional tolerance of bolt hole.

unit : mm

housing No.			$\Delta N_s$
F204- F218	FX05- FX18	F305- F315	$\pm 0.2$
	FX20	F316- F328	$\pm 0.3$

$\Delta N_s$  : deviation of bolt hole diameter.

Shaft dia. (mm) <i>d</i>	Dimensions (mm)									Bolt size	Unit No.	Housing No.	Applicable bearing			Unit No. with covers				Cover dimensions (mm)		(Refer.) Unit mass (kg)			
	<i>L</i>	<i>A</i>	<i>J</i>	<i>N</i>	<i>A</i> <sub>1</sub>	<i>A</i> <sub>2</sub>	<i>A</i> <sub>0</sub>	<i>B</i>	<i>S</i>				No.	Basic load ratings (kN)		Factor		Pressed steel covers		Cast iron covers		<i>A</i> <sub>s</sub>	<i>A</i> <sub>c</sub>	Pressed steel covers	Cast iron covers
	<i>C</i> <sub>r</sub>	<i>C</i> <sub>0r</sub>	<i>f</i> <sub>0</sub>	Open ends	Closed end	Open ends	Closed end																		
55	175	49	143	19	20	29	68.7	65.1	25.4	M16	UCFX11	FX11	UCX11	52.4	36.2	14.4	UCFX11C	UCFX11D	—	—	73	—	4.9	—	
	185	52	140	23	20	30	71	66	25	M20	UCF311	F311	UC311	71.6	45.0	13.2	—	—	UCF311C	UCF311D	—	87	5.6	6.5	
60	175	48	143	19	18	29	68.7	65.1	25.4	M16	UCF212	F212	UC212	52.4	36.2	14.4	UCF212C	UCF212D	UCF212FC	UCF212FD	73	86	4.2	5.0	
	187	59	149	19	21	34	73.7	65.1	25.4	M16	UCFX12	FX12	UCX12	57.2	40.1	14.4	UCFX12C	UCFX12D	—	—	78	—	5.7	—	
	195	56	150	23	22	33	78	71	26	M20	UCF312	F312	UC312	81.9	52.2	13.2	—	—	UCF312C	UCF312D	—	95	6.9	8.1	
65	187	50	149	19	22	30	69.7	65.1	25.4	M16	UCF213	F213	UC213	57.2	40.1	14.4	UCF213C	UCF213D	UCF213FC	UCF213FD	74	87	5.2	6.0	
	187	59	149	19	21	34	78.4	74.6	30.2	M16	UCFX13	FX13	UCX13	62.2	44.1	14.5	UCFX13C	UCFX13D	—	—	83	—	6.3	—	
	208	58	166	23	22	33	78	75	30	M20	UCF313	F313	UC313	92.7	59.9	13.2	—	—	UCF313C	UCF313D	—	94	7.8	8.9	
70	193	54	152	19	22	31	75.4	74.6	30.2	M16	UCF214	F214	UC214	62.2	44.1	14.5	UCF214C	UCF214D	UCF214FC	UCF214FD	80	93	5.9	6.8	
	197	60	152	23	22	37	81.5	77.8	33.3	M20	UCFX14	FX14	UCX14	67.4	48.3	14.5	UCFX14C	UCFX14D	—	—	86	—	7.0	—	
	226	61	178	25	25	36	81	78	33	M22	UCF314	F314	UC314	104	68.2	13.2	—	—	UCF314C	UCF314D	—	98	10.1	11.2	
75	200	56	159	19	22	34	78.5	77.8	33.3	M16	UCF215	F215	UC215	67.4	48.3	14.5	UCF215C	UCF215D	UCF215FC	UCF215FD	83	96	6.4	7.4	
	197	68	152	23	24	40	89.3	82.6	33.3	M20	UCFX15	FX15	UCX15	72.7	53.0	14.6	UCFX15C	UCFX15D	—	—	94	—	8.4	—	
	236	66	184	25	25	39	89	82	32	M22	UCF315	F315	UC315	113	77.2	13.2	—	—	UCF315C	UCF315D	—	106	11.6	12.9	
80	208	58	165	23	22	34	83.3	82.6	33.3	M20	UCF216	F216	UC216	72.7	53.0	14.6	UCF216C	UCF216D	UCF216FC	UCF216FD	88	103	7.3	8.5	
	214	70	171	23	24	40	91.6	85.7	34.1	M20	UCFX16	FX16	UCX16	84.0	61.9	14.5	UCFX16C	UCFX16D	—	—	96	—	9.4	—	
	250	68	196	31	27	38	90	86	34	M27	UCF316	F316	UC316	123	86.7	13.3	—	—	UCF316C	UCF316D	—	107	12.8	14.2	
85	220	63	175	23	24	36	87.6	85.7	34.1	M20	UCF217	F217	UC217	84.0	61.9	14.5	UCF217C	UCF217D	UCF217FC	UCF217FD	92	107	8.9	10.3	
	214	70	171	23	24	40	96.3	96	39.7	M20	UCFX17	FX17	UCX17	96.1	71.5	14.5	UCFX17C	UCFX17D	—	—	101	—	10.8	—	
	260	74	204	31	27	44	100	96	40	M27	UCF317	F317	UC317	133	96.8	13.3	—	—	UCF317C	UCF317D	—	117	15.3	16.9	
90	235	68	187	23	25	40	96.3	96	39.7	M20	UCF218	F218	UC218	96.1	71.5	14.5	UCF218C	UCF218D	UCF218FC	UCF218FD	101	116	11.4	12.9	
	214	76	171	23	24	45	106.1	104	42.9	M20	UCFX18	FX18	UCX18	109	81.9	14.4	—	—	UCFX18C	UCFX18D	—	124	11.9	13.6	
	280	76	216	35	30	44	100	96	40	M30	UCF318	F318	UC318	143	107	13.3	—	—	UCF318C	UCF318D	—	119	18.9	20.8	
95	290	94	228	35	30	59	121	103	41	M30	UCF319	F319	UC319	153	119	13.3	—	—	UCF319C	UCF319D	—	140	21.6	23.8	

(Remarks) 1) Applicable sizes of grease nipples are shown below.  
A-1/4-28UNF ..... 201~210, X05~X09, 305~308  
A-PT 1/8 ..... 211~218, X10~X20, 309~328

2) For bearings with double- or triple-lip seals, unit and bearing number are suffixed by L2 or L3.  
(UCF206JL3, UC206L3)

3) For more detailed information, refer to ball bearing for unit specification tables.

**Ball bearing units**  
**square-flanged type**  
**UCF (with set screws)**

*d* 100 ~ 140 mm

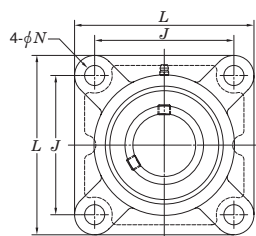
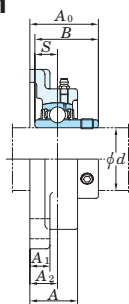

Pressed steel cover

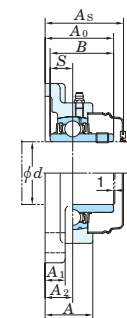

Cast iron cover

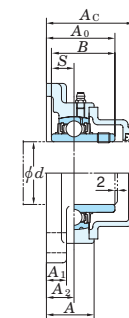

Tolerances for housing

unit : mm

housing No.			$\Delta A_{2s}$	X
F204~ F210	FX05~ FX10	F305~ F310	$\pm 0.5$	0.7
F211~ F218	FX11~ FX20	F311~ F328	$\pm 0.8$	1

$\Delta A_{2s}$  : deviation of distance from mounting face to centre of spherical bearing seating.

X : positional tolerance of bolt hole.

unit : mm

housing No.			$\Delta N_s$
F204~ F218	FX05~ FX18	F305~ F315	$\pm 0.2$
	FX20	F316~ F328	$\pm 0.3$

$\Delta N_s$  : deviation of bolt hole diameter.

Shaft dia. (mm) <i>d</i>	Dimensions (mm)									Bolt size	Unit No.	Housing No.	Applicable bearing			Unit No. with covers				Cover dimensions (mm)		Unit mass (kg)		
	<i>L</i>	<i>A</i>	<i>J</i>	<i>N</i>	<i>A</i> <sub>1</sub>	<i>A</i> <sub>2</sub>	<i>A</i> <sub>0</sub>	<i>B</i>	<i>S</i>				No.	Basic load ratings (kN)		Factor <i>f</i> <sub>0</sub>	Pressed steel covers		Cast iron covers		<i>A</i> <sub>s</sub>	<i>A</i> <sub>c</sub>	Pressed steel covers	Cast iron covers
														<i>C</i> <sub>r</sub>	<i>C</i> <sub>0r</sub>		Open ends	Closed end	Open ends	Closed end				
<b>100</b>	268	97	211	31	28	59	127.3	117.5	49.2	M27	<b>UCFX20</b>	FX20	UCX20	133	105	14.4	—	—	UCFX20C	UCFX20D	—	152	19.4	21.6
	310	94	242	38	32	59	125	108	42	M33	<b>UCF320</b>	F320	UC320	173	141	13.2	—	—	UCF320C	UCF320D	—	146	25.8	28.6
<b>105</b>	310	94	242	38	32	59	127	112	44	M33	<b>UCF321</b>	F321	UC321	184	153	13.2	—	—	UCF321C	UCF321D	—	148	30.2	33.2
<b>110</b>	340	96	266	41	35	60	131	117	46	M36	<b>UCF322</b>	F322	UC322	205	180	13.2	—	—	UCF322C	UCF322D	—	154	35.3	41.7
<b>120</b>	370	110	290	41	40	65	140	126	51	M36	<b>UCF324</b>	F324	UC324	207	185	13.5	—	—	UCF324C	UCF324D	—	163	47.3	52.1
<b>130</b>	410	115	320	41	45	65	146	135	54	M36	<b>UCF326</b>	F326	UC326	229	214	13.6	—	—	UCF326C	UCF326D	—	172	65.5	71.6
<b>140</b>	450	125	350	41	55	75	161	145	59	M36	<b>UCF328</b>	F328	UC328	253	246	13.6	—	—	UCF328C	UCF328D	—	186	93.4	101

[Remarks] 1) Applicable sizes of grease nipples are shown below.  
A-1/4-28UNF ..... 201~210, X05~X09, 305~308  
A-PT 1/8 ..... 211~218, X10~X20, 309~328

2) For bearings with double- or triple-lip seals, unit and bearing number are suffixed by L2 or L3.  
(UCF206JL3, UC206L3)  
3) For more detailed information, refer to ball bearing for unit specification tables.

**Ball bearing units**  
**square-flanged type with spigot joint**  
**UCFS (with set screws)**

$d$  25 ~ 105 mm

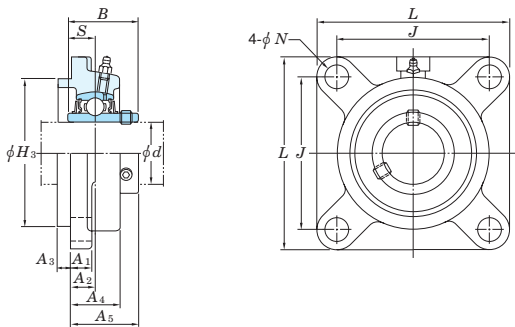

Cast iron cover

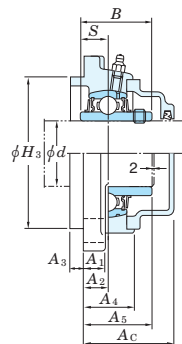

Tolerances for housing

housing No.	$\Delta H_{3s}$	$\Delta A_{2s}$	unit : mm	
			X	Y
FS305	0 -0.046	±0.5	0.7	0.2
FS306- FS308	0 -0.054			
FS309- FS310	0 -0.063			
FS311- FS313	0 -0.072	±0.8	1	0.3
FS314- FS319	0 -0.072			-FS318 FS319-
FS320- FS322	0 -0.081			0.4
FS324- FS328	0 -0.089			

unit : mm	
housing No.	$\Delta N_s$
FS305-315	±0.2
FS316-328	±0.3

$\Delta N_s$  : deviation of bolt hole diameter.

$\Delta H_{3s}$  : deviation of spigot joint outside diameter.  
 $\Delta A_{2s}$  : deviation of distance from mounting face to centre of spherical bearing seating.  
 X : positional tolerance of bolt hole.  
 Y : circumferential runout tolerance of spigot joint in respect to axial line of spherical bearing seating.

Shaft dia. (mm)	Dimensions (mm)											Bolt size	Unit No.	Housing No.	Applicable bearing			Unit No. with covers		Cover dimensions (mm) $A_e$	(Refer.) Unit mass (kg)		
	$d$	$L$	$H_3$	$J$	$N$	$A_1$	$A_2$	$A_3$	$A_4$	$A_5$	$B$				$S$	No.	Basic load ratings (kN) $C_r$ $C_{0r}$	Factor $f_0$	Open ends		Closed end	No cover	Cast iron covers
25	110	80	80	16	13	9	7	22	32	38	15	M14	UCFS305	FS305	UC305	21.2	10.9	12.6	UCFS305C	UCFS305D	47	1.4	1.7
30	125	90	95	16	15	10	8	24	36	43	17	M14	UCFS306	FS306	UC306	26.7	15.0	13.3	UCFS306C	UCFS306D	51	1.9	2.2
35	135	100	100	19	16	11	9	27	40	48	19	M16	UCFS307	FS307	UC307	33.4	19.3	13.2	UCFS307C	UCFS307D	55	2.3	2.7
40	150	115	112	19	17	13	10	30	46	52	19	M16	UCFS308	FS308	UC308	40.7	24.0	13.2	UCFS308C	UCFS308D	61	3.4	3.9
45	160	125	125	19	18	14	11	33	49	57	22	M16	UCFS309	FS309	UC309	48.9	29.5	13.3	UCFS309C	UCFS309D	65	4.4	5.0
50	175	140	132	23	19	16	12	36	55	61	22	M20	UCFS310	FS310	UC310	62.0	38.3	13.2	UCFS310C	UCFS310D	71	5.3	6.1
55	185	150	140	23	20	17	13	39	58	66	25	M20	UCFS311	FS311	UC311	71.6	45.0	13.2	UCFS311C	UCFS311D	74	6.1	7.0
60	195	160	150	23	22	19	14	42	64	71	26	M20	UCFS312	FS312	UC312	81.9	52.2	13.2	UCFS312C	UCFS312D	81	7.4	8.6
65	208	175	166	23	22	15	18	40	60	75	30	M20	UCFS313	FS313	UC313	92.7	59.9	13.2	UCFS313C	UCFS313D	76	8.8	9.9
70	226	185	178	25	25	18	18	43	63	78	33	M22	UCFS314	FS314	UC314	104	68.2	13.2	UCFS314C	UCFS314D	80	11.2	12.3
75	236	200	184	25	25	21	18	48	71	82	32	M22	UCFS315	FS315	UC315	113	77.2	13.2	UCFS315C	UCFS315D	88	13.7	15.0
80	250	210	196	31	27	18	20	48	70	86	34	M27	UCFS316	FS316	UC316	123	86.7	13.3	UCFS316C	UCFS316D	87	15.1	16.5
85	260	220	204	31	27	24	20	54	80	96	40	M27	UCFS317	FS317	UC317	133	96.8	13.3	UCFS317C	UCFS317D	97	17.3	18.9
90	280	240	216	35	30	24	20	56	80	96	40	M30	UCFS318	FS318	UC318	143	107	13.3	UCFS318C	UCFS318D	99	21.3	23.2
95	290	250	228	35	30	39	20	74	101	103	41	M30	UCFS319	FS319	UC319	153	119	13.3	UCFS319C	UCFS319D	120	24.5	26.7
100	310	260	242	38	32	39	20	74	105	108	42	M33	UCFS320	FS320	UC320	173	141	13.2	UCFS320C	UCFS320D	126	29.5	32.3
105	310	260	242	38	32	39	20	74	107	112	44	M33	UCFS321	FS321	UC321	184	153	13.2	UCFS321C	UCFS321D	128	32.7	35.7

[Remarks] 1) Applicable sizes of grease nipples are shown below.  
 A-1/4-28UNF ..... 305~308  
 A-PT 1/8 ..... 309~328

2) Bearings with triple-lip seals are indicated by L3 after the bearing and unit number.  
 (UCFS307JL3, UC307L3)  
 3) For more detailed information, refer to ball bearing for unit specification tables.

**Ball bearing units**  
**square-flanged type with spigot joint**  
**UCFS (with set screws)**

*d* 110 ~ 140 mm

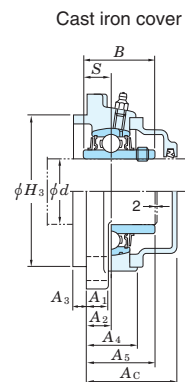
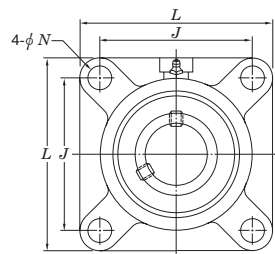
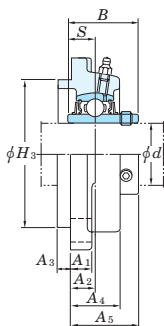

Tolerances for housing

housing No.	$\Delta H_{3s}$	$\Delta A_{2s}$	unit : mm	
			X	Y
FS305	0 -0.046	±0.5	0.7	0.2
FS306- FS308	0 -0.054			
FS309- FS310	0 -0.063			
FS311- FS313	0 -0.072	±0.8	1	0.3
FS314- FS319	0 -0.072			~FS318 FS319~
FS320- FS322	0 -0.081			0.4
FS324- FS328	0 -0.089			

unit : mm	
housing No.	$\Delta N_s$
FS305-315	±0.2
FS316-328	±0.3

$\Delta N_s$  : deviation of bolt hole diameter.

$\Delta H_{3s}$  : deviation of spigot joint outside diameter.  
 $\Delta A_{2s}$  : deviation of distance from mounting face to centre of spherical bearing seating.  
 X : positional tolerance of bolt hole.  
 Y : circumferential runout tolerance of spigot joint in respect to axial line of spherical bearing seating.

Shaft dia. (mm)	Dimensions (mm)											Bolt size	Unit No.	Housing No.	Applicable bearing			Unit No. with covers		Cover dimensions (mm) <i>A<sub>c</sub></i>	(Refer.) Unit mass (kg)		
	<i>d</i>	<i>L</i>	<i>H<sub>3</sub></i>	<i>J</i>	<i>N</i>	<i>A<sub>1</sub></i>	<i>A<sub>2</sub></i>	<i>A<sub>3</sub></i>	<i>A<sub>4</sub></i>	<i>A<sub>5</sub></i>	<i>B</i>				<i>S</i>	No.	Basic load ratings (kN) <i>C<sub>r</sub></i> <i>C<sub>0r</sub></i>	Factor <i>f<sub>0</sub></i>	Open ends		Closed end	No cover	Cast iron covers
<b>110</b>	340	300	266	41	35	35	25	71	106	117	46	M36	<b>UCFS322</b>	FS322		UC322	205    180	13.2	UCFS322C	UCFS322D	129	39.0	42.4
<b>120</b>	370	330	290	41	40	35	30	80	110	126	51	M36	<b>UCFS324</b>	FS324		UC324	207    185	13.5	UCFS324C	UCFS324D	133	50.6	55.4
<b>130</b>	410	360	320	41	45	35	30	85	116	135	54	M36	<b>UCFS326</b>	FS326		UC326	229    214	13.6	UCFS326C	UCFS326D	142	67.7	73.8
<b>140</b>	450	400	350	41	55	45	30	95	131	145	59	M36	<b>UCFS328</b>	FS328		UC328	253    246	13.6	UCFS328C	UCFS328D	156	94.0	102

[Remarks] 1) Applicable sizes of grease nipples are shown below.  
 A-1/4-28UNF ..... 305~308  
 A-PT 1/8 ..... 309~328

2) Bearings with triple-lip seals are indicated by L3 after the bearing and unit number.  
 (UCFS307JL3, UC307L3)  
 3) For more detailed information, refer to ball bearing for unit specification tables.

**Ball bearing units  
rhombic-flanged type  
UCFL (with set screws)**

$d$  12 ~ 55 mm

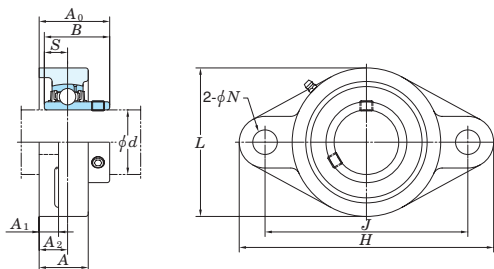

Pressed steel cover

Cast iron cover

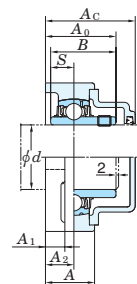
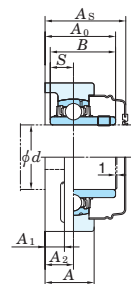

Tolerances for housing

unit : mm				unit : mm				
housing No.		$\Delta N_s$	housing No.		$\Delta A_{2s}$	X		
FL204-FL216	FLX05-FLX10	FL305-FL311	$\pm 0.2$	FL204-FL210	FLX05-FLX10	FL305-FL310	$\pm 0.5$	0.7
	FL312-FL328		$\pm 0.3$	FL211-FL218		FL311-FL328	$\pm 0.8$	1

$\Delta N_s$  : deviation of bolt hole diameter.

$\Delta A_{2s}$  : deviation of distance from mounting face to centre of spherical bearing seating.

X : positional tolerance of bolt hole.

FL204JE3, FL205JE3 (with cast iron covers) are shown below.

FL204JE3  $L_c = 65$  mm  
FL205JE3  $L_c = 73$  mm

Shaft dia. (mm) $d$	Dimensions (mm)											Bolt size	Unit No.	Housing No.	Applicable bearing			Unit No. with covers				Cover dimensions (mm)		(Refer.) Unit mass (kg)								
	$H$	$L$	$A$	$J$	$N$	$A_1$	$A_2$	$A_0$	$B$	$S$	No.				Basic load ratings (kN) $C_r$	$C_{0r}$	Factor $f_0$	Pressed steel covers Open ends	Pressed steel covers Closed end	Cast iron covers Open ends	Cast iron covers Closed end	$A_s$	$A_c$	Pressed steel covers	Cast iron covers							
12	113	60	25.5	90	12	11	15	33.3	31	12.7	M10	UCFL201	FL204	UC201	12.8	6.65	13.2	UCFL201C	UCFL201D	—	—	37	—	0.50	—							
	15	113	60	25.5	90	12	11	15	33.3	31	12.7							M10	UCFL202	FL204	UC202	12.8	6.65	13.2	UCFL202C	UCFL202D	—	—	37	—	0.48	—
		17	113	60	25.5	90	12	11	15	33.3	31							12.7							M10	UCFL203	FL204	UC203	12.8	6.65	13.2	UCFL203C
20	113		60	25.5	90	12	11	15	33.3	31	12.7	M10	UCFL204	FL204	UC204	12.8	6.65	13.2	UCFL204C	UCFL204D	UCFL204FC	UCFL204FD	37	46	0.45							0.60
	25		130	68	27	99	16	13	16	35.8	34.1	14.3							M14	UCFL205	FL205	UC205	14.0	7.85	13.9							UCFL205C
141		83	30	117	12	13	18	40.2	38.1	15.9	M10	UCFLX05	FLX05	UCX05	19.5	11.3	13.9	UCFLX05C	UCFLX05D							—	—	44	—	1.1	—	
		150	80	29	113	19	13	16	39	38	15							M16	UCFL305							FL305	UC305	21.2	10.9	12.6	—	—
30	148	80	31	117	16	13	18	40.2	38.1	15.9	M14	UCFL206	FL206	UC206	19.5	11.3	13.9	UCFL206C		UCFL206D	UCFL206FC	UCFL206FD	44	53	0.93						1.2	
	156	95	34	130	16	14	19	44.4	42.9	17.5	M14							UCFLX06		FLX06	UCX06	25.7	15.4	13.9	UCFLX06C						UCFLX06D	—
		180	90	32	134	23	15	18	44	43	17								M20						UCFL306	FL306	UC306	26.7	15.0	13.3	—	—
35	161	90	34	130	16	14	19	44.4	42.9	17.5	M14	UCFL207	FL207	UC207	25.7	15.4	13.9	UCFL207C	UCFL207D	UCFL207FC	UCFL207FD	49	58	1.2							1.6	
	171	105	38	144	16	14	21	51.2	49.2	19	M14							UCFLX07	FLX07	UCX07	29.1	17.8	14.0	UCFLX07C							UCFLX07D	—
		185	100	36	141	23	16	20	49	48	19													M20	UCFL307	FL307	UC307	33.4	19.3	13.2	—	—
40	175	100	36	144	16	14	21	51.2	49.2	19	M14	UCFL208	FL208	UC208	29.1	17.8	14.0	UCFL208C	UCFL208D	UCFL208FC	UCFL208FD	55	64	1.6							2.0	
	179	111	40	148	16	14	22	52.2	49.2	19	M14							UCFLX08	FLX08	UCX08	32.7	20.3	14.0	UCFLX08C							UCFLX08D	—
		200	112	40	158	23	17	23	56	52	19													M20	UCFL308	FL308	UC308	40.7	24.0	13.2	—	—
45	188	108	38	148	19	15	22	52.2	49.2	19	M16	UCFL209	FL209	UC209	32.7	20.3	14.0	UCFL209C	UCFL209D	UCFL209FC	UCFL209FD	56	66	1.9							2.3	
	189	116	40	157	16	14	23	55.6	51.6	19	M14							UCFLX09	FLX09	UCX09	35.1	23.3	14.4	UCFLX09C							UCFLX09D	—
		230	125	44	177	25	18	25	60	57	22													M22	UCFL309	FL309	UC309	48.9	29.5	13.3	—	—
50	197	115	40	157	19	15	22	54.6	51.6	19	M16	UCFL210	FL210	UC210	35.1	23.3	14.4	UCFL210C	UCFL210D	UCFL210FC	UCFL210FD	59	70.5	2.2							2.7	
	216	133	44	184	19	20	26	59.4	55.6	22.2	M16							UCFLX10	FLX10	UCX10	43.4	29.4	14.4	UCFLX10C							UCFLX10D	—
		240	140	48	187	25	19	28	67	61	22													M22	UCFL310	FL310	UC310	62.0	38.3	13.2	—	—
55	224	130	43	184	19	18	25	58.4	55.6	22.2	M16	UCFL211	FL211	UC211	43.4	29.4	14.4	UCFL211C	UCFL211D	UCFL211FC	UCFL211FD	63	74.5	3.3							3.9	
	250	150	52	198	25	20	30	71	66	25	M22							UCFL311	FL311	UC311	71.6	45.0	13.2	—							—	UCFL311C

(Remarks) 1) Applicable sizes of grease nipples are shown below.  
A-1/4-28UNF ..... 201~210, X05~X09, 305~308  
A-PT 1/8 ..... 211~217, X10~X17, 309~328

2) Bearings with triple-lip seals are indicated by L3 after the bearing and unit number.  
(UCFS307JL3, UC307L3)  
3) For more detailed information, refer to ball bearing for unit specification tables.

**Ball bearing units**  
**rhombic-flanged type**  
**UCFL (with set screws)**

*d* 60 ~ 140 mm

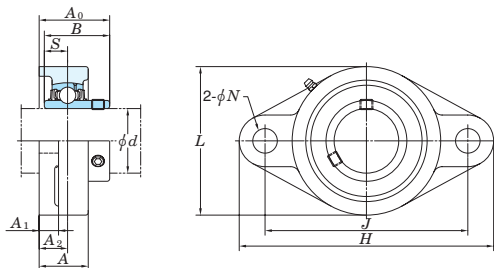

Pressed steel cover

Cast iron cover

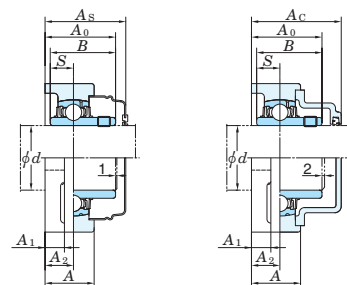

Tolerances for housing

unit : mm

housing No.	$\Delta N_s$
FL204-FL218	$\pm 0.2$
FLX05-FLX10	$\pm 0.3$
FL305-FL311	$\pm 0.2$
FL312-FL328	$\pm 0.3$

housing No.	$\Delta A_{2s}$	X
FL204-FL210	$\pm 0.5$	0.7
FLX05-FLX10	$\pm 0.5$	0.7
FL305-FL310	$\pm 0.5$	0.7
FL211-FL218	$\pm 0.8$	1
FL311-FL328	$\pm 0.8$	1

$\Delta N_s$  : deviation of bolt hole diameter.

$\Delta A_{2s}$  : deviation of distance from mounting face to centre of spherical bearing seating.

X : positional tolerance of bolt hole.

Shaft dia. (mm) <i>d</i>	Dimensions (mm)										Bolt size	Unit No.	Housing No.	Applicable bearing			Unit No. with covers				Cover dimensions (mm)		(Refer.) Unit mass (kg)			
	<i>H</i>	<i>L</i>	<i>A</i>	<i>J</i>	<i>N</i>	<i>A</i> <sub>1</sub>	<i>A</i> <sub>2</sub>	<i>A</i> <sub>0</sub>	<i>B</i>	<i>S</i>				No.	Basic load ratings (kN) <i>C<sub>r</sub></i>	<i>C</i> <sub>0r</sub>	Factor <i>f</i> <sub>0</sub>	Pressed steel covers		Cast iron covers		<i>A</i> <sub>s</sub>	<i>A</i> <sub>c</sub>	Pressed steel covers	Cast iron covers	
																Open ends	Closed end	Open ends	Closed end							
60	250	140	48	202	23	18	29	68.7	65.1	25.4	M20	UCFL212 UCFL312	FL212 FL312		UC212 UC312	52.4	36.2	14.4	UCFL212C	UCFL212D	UCFL212FC	UCFL212FD	73	86	4.2	5.0
	270	160	56	212	31	22	33	78	71	26	M27					81.9	52.2	13.2	—	—	UCFL312C	UCFL312D	—	95	6.5	7.7
65	258	155	50	210	23	20	30	69.7	65.1	25.4	M20	UCFL213 UCFL313	FL213 FL313	UC213 UC313	57.2	40.1	14.4	UCFL213C	UCFL213D	UCFL213FC	UCFL213FD	74	87	5.1	5.9	
	295	175	58	240	31	25	33	78	75	30	M27				92.7	59.9	13.2	—	—	UCFL313C	UCFL313D	—	94	8.5	9.6	
70	265	160	54	216	23	20	31	75.4	74.6	30.2	M20	UCFL214 UCFL314	FL214 FL314	UC214 UC314	62.2	44.1	14.5	UCFL214C	UCFL214D	UCFL214FC	UCFL214FD	80	93	5.7	6.6	
	315	185	61	250	35	28	36	81	78	33	M30				104	68.2	13.2	—	—	UCFL314C	UCFL314D	—	98	9.7	10.8	
75	275	165	56	225	23	20	34	78.5	77.8	33.3	M20	UCFL215 UCFL315	FL215 FL315	UC215 UC315	67.4	48.3	14.5	UCFL215C	UCFL215D	UCFL215FC	UCFL215FD	83	96	6.4	7.4	
	320	195	66	260	35	30	39	89	82	32	M30				113	77.2	13.2	—	—	UCFL315C	UCFL315D	—	106	11.3	12.6	
80	290	180	58	233	25	20	34	83.3	82.6	33.3	M22	UCFL216 UCFL316	FL216 FL316	UC216 UC316	72.7	53.0	14.6	UCFL216C	UCFL216D	UCFL216FC	UCFL216FD	88	103	7.8	9.0	
	355	210	68	285	38	32	38	90	86	34	M33				123	86.7	13.3	—	—	UCFL316C	UCFL316D	—	107	14.4	15.8	
85	305	190	63	248	25	22	36	87.6	85.7	34.1	M22	UCFL217 UCFL317	FL217 FL317	UC217 UC317	84.0	61.9	14.5	UCFL217C	UCFL217D	UCFL217FC	UCFL217FD	92	107	9.8	11.2	
	370	220	74	300	38	32	44	100	96	40	M33				133	96.8	13.3	—	—	UCFL317C	UCFL317D	—	117	16.0	17.6	
90	320	205	68	265	25	23	40	96.3	96	39.7	M22	UCFL218 UCFL318	FL218 FL318	UC218 UC318	96.1	71.5	14.5	UCFL218C	UCFL218D	UCFL218FC	UCFL218FD	101	116	12.3	13.8	
	385	235	76	315	38	36	44	100	96	40	M33				143	107	13.3	—	—	UCFL318C	UCFL318D	—	119	19.0	20.9	
95	405	250	94	330	41	40	59	121	103	41	M36	UCFL319	FL319	UC319	153	119	13.3	—	—	UCFL319C	UCFL319D	—	140	24.6	26.8	
100	440	270	94	360	44	40	59	125	108	42	M39	UCFL320	FL320	UC320	173	141	13.2	—	—	UCFL320C	UCFL320D	—	146	29.4	32.2	
105	440	270	94	360	44	40	59	127	112	44	M39	UCFL321	FL321	UC321	184	153	13.2	—	—	UCFL321C	UCFL321D	—	148	34.4	37.4	
110	470	300	96	390	44	42	60	131	117	46	M39	UCFL322	FL322	UC322	205	180	13.2	—	—	UCFL322C	UCFL322D	—	154	36.2	39.6	
120	520	330	110	430	47	48	65	140	126	51	M42	UCFL324	FL324	UC324	207	185	13.5	—	—	UCFL324C	UCFL324D	—	163	51.6	56.4	
130	550	360	115	460	47	50	65	146	135	54	M42	UCFL326	FL326	UC326	229	214	13.6	—	—	UCFL326C	UCFL326D	—	172	61.6	67.7	
140	600	400	125	500	51	60	75	161	145	59	M45	UCFL328	FL328	UC328	253	246	13.6	—	—	UCFL328C	UCFL328D	—	186	68.4	76.1	

(Remarks) 1) Applicable sizes of grease nipples are shown below.  
A-1/4-28UNF ..... 201~210, X05~X09, 305~308  
A-PT 1/8 ..... 211~217, X10~X17, 309~328

2) Bearings with triple-lip seals are indicated by L3 after the bearing and unit number.  
(UCFS307JL3, UC307L3)  
3) For more detailed information, refer to ball bearing for unit specification tables.

**Ball bearing units**  
**light duty rhombic-flanged type**  
**BLF (with set screws)**

*d* 12 ~ 35 mm

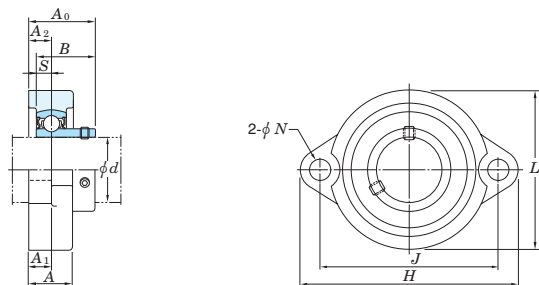

Shaft dia. (mm) <i>d</i>	Dimensions (mm)										Bolt size	Unit No.	Housing No.	No.	Applicable bearing		Factor <i>f</i> <sub>0</sub>	(Refer.) Unit mass (kg)
	<i>H</i>	<i>L</i>	<i>A</i>	<i>J</i> ±0.7	<i>N</i> ±0.2	<i>A</i> <sub>1</sub>	<i>A</i> <sub>2</sub> ±0.5	<i>A</i> <sub>0</sub>	<i>B</i>	<i>S</i>					<i>C</i> <sub>r</sub>	<i>C</i> <sub>0r</sub>		
12	81	52	18	63.5	8	9.5	9.5	25.5	22	6	M6	BLF201	LF203	SB201	9.55	4.80	13.2	0.25
15	81	52	18	63.5	8	9.5	9.5	25.5	22	6	M6	BLF202	LF203	SB202	9.55	4.80	13.2	0.25
17	81	52	18	63.5	8	9.5	9.5	25.5	22	6	M6	BLF203	LF203	SB203	9.55	4.80	13.2	0.25
20	90	60	20	71.5	10	11	11	29	25	7	M8	BLF204	LF204	SB204	12.8	6.65	13.2	0.33
25	95	64	20	76	10	11	11	30.5	27	7.5	M8	BLF205	LF205	SB205	14.0	7.85	13.9	0.38
30	113	76	22.5	90.5	12	12	12	34	30	8	M10	BLF206	LF206	SB206	19.5	11.3	13.9	0.57
35	122	89	24	100	12	13	13	36.5	32	8.5	M10	BLF207	LF207	SB207	25.7	15.4	13.9	0.77

[Remarks] 1) The radial loading on housing should not exceed 50% of the basic load rating (*C*<sub>r</sub>).  
 2) For more detailed information, refer to ball bearing for unit specification tables.



**Ball bearing units**  
**“compact” series rhombic-flanged type**

**UFL (with set screws)**

*d* 8 ~ 30 mm

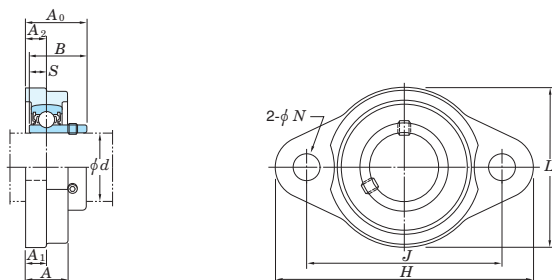

Open ends type

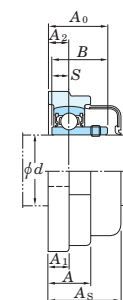

Closed end type

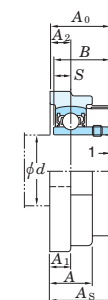

Tolerance for housing

unit : mm	
housing No.	X
FL000-FL006	0.6

X : positional tolerance of bolt hole.

Shaft dia. (mm) <i>d</i>	Dimensions (mm)										Bolt size	Unit No.	Housing No.	No.	Applicable bearing			Unit No. with covers		Cover dimension (mm) <i>A<sub>s</sub></i>	(Refer.) Unit mass (kg)
	<i>H</i>	<i>L</i>	<i>A</i>	<i>J</i>	<i>N</i> ±0.2	<i>A<sub>1</sub></i>	<i>A<sub>2</sub></i> ±0.5	<i>A<sub>0</sub></i>	<i>B</i>	<i>S</i>					Basic load ratings (kN) <i>C<sub>r</sub></i> <i>C<sub>0r</sub></i>	Factor <i>f<sub>0</sub></i>	Open ends	Closed end			
<b>8</b>	48	27	8.5	37	4.8	4	4	12.5	12	3.5	M4	<b>UFL08</b>	FL08	SU08	3.27	1.37	12.4	—	—	—	0.030
<b>10</b>	60	36	12	45	7	6	6	16	15	5	M6	<b>UFL000</b>	FL000	SU000	4.55	1.95	12.3	UFL000C	UFL000D	20.5	0.050
<b>12</b>	63	38	12	48	7	6	6	16	15	5	M6	<b>UFL001</b>	FL001	SU001	5.10	2.40	13.2	UFL001C	UFL001D	20.5	0.065
<b>15</b>	67	42	13	53	7	6.5	6.5	17.5	16.5	5.5	M6	<b>UFL002</b>	FL002	SU002	5.60	2.85	13.9	UFL002C	UFL002D	22	0.085
<b>17</b>	71	46	14	56	7	7	7	18.5	17.5	6	M6	<b>UFL003</b>	FL003	SU003	6.00	3.25	14.4	UFL003C	UFL003D	23.5	0.11
<b>20</b>	90	55	16	71	10	8	8	22	21	7	M8	<b>UFL004</b>	FL004	SU004	9.40	5.05	13.9	UFL004C	UFL004D	27	0.18
<b>25</b>	95	60	16	75	10	8	8	23	22	7	M8	<b>UFL005</b>	FL005	SU005	10.1	5.85	14.5	UFL005C	UFL005D	28	0.23
<b>30</b>	112	70	18	85	13	9	9	26	24.5	7.5	M10	<b>UFL006</b>	FL006	SU006	13.2	8.25	14.7	UFL006C	UFL006D	31	0.31

[Remarks] 1) Housing is made from special light alloy.  
 2) For more detailed information, refer to ball bearing for unit specification tables.

**Ball bearing units**  
**stainless-series rhombic-flanged type**  
**UCSFL-H1S6 (with set screws)**

*d* 12 ~ 50 mm

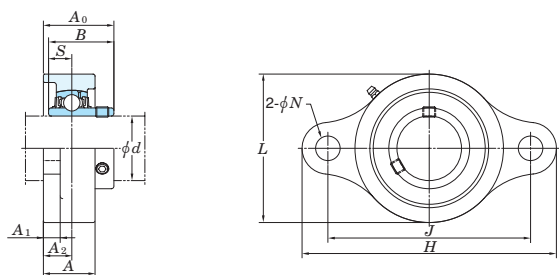

Pressed stainless steel covers

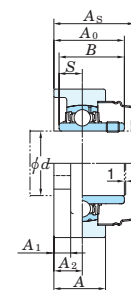

Tolerance for housing

unit : mm	
housing No.	X
SFL203 H1-210 H1	0.7

X : positional tolerance of bolt hole.

Shaft dia. (mm) <i>d</i>	Dimensions (mm)											Bolt size	Unit No.	Housing No.	No.	Applicable bearing			Unit No. with covers		Cover dimension (mm) <i>A<sub>s</sub></i>	(Refer.) Unit mass (kg) Pressed steel covers
	<i>H</i>	<i>L</i>	<i>A</i>	<i>J</i>	<i>N</i> ±0.2	<i>A<sub>1</sub></i>	<i>A<sub>2</sub></i> ±0.5	<i>A<sub>0</sub></i>	<i>B</i>	<i>S</i>	Basic load ratings (kN) <i>C<sub>r</sub></i>					<i>C<sub>0r</sub></i>	Factor <i>f<sub>0</sub></i>	Open ends	Closed end			
12	98	54	24	76.5	12	10	14	29.9	27.4	11.5	M10	<b>UCSFL201XH1S6</b>	SFL203H1		UC201XS6	8.15	3.85	13.2	—	—	—	0.31
15	98	54	24	76.5	12	10	14	29.9	27.4	11.5	M10	<b>UCSFL202XH1S6</b>	SFL203H1		UC202XS6	8.15	3.85	13.2	—	—	—	0.31
17	98	54	24	76.5	12	10	14	29.9	27.4	11.5	M10	<b>UCSFL203XH1S6</b>	SFL203H1		UC203XS6	8.15	3.85	13.2	—	—	—	0.31
20	113	60	26	90	12	10	15	33.3	31	12.7	M10	<b>UCSFL204H1S6</b>	SFL204H1		UC204S6	10.9	5.35	13.2	UCSFL204H1CS6	UCSFL204H1DS6	38	0.43
25	130	68	27.5	99	16	10	16	35.8	34.1	14.3	M14	<b>UCSFL205H1S6</b>	SFL205H1		UC205S6	11.9	6.30	13.9	UCSFL205H1CS6	UCSFL205H1DS6	40	0.60
30	148	80	31	117	16	10	18	40.2	38.1	15.9	M14	<b>UCSFL206H1S6</b>	SFL206H1		UC206S6	16.5	9.05	13.9	UCSFL206H1CS6	UCSFL206H1DS6	45	0.86
35	161	90	34	130	16	11	19	44.4	42.9	17.5	M14	<b>UCSFL207H1S6</b>	SFL207H1		UC207S6	21.8	12.3	13.9	UCSFL207H1CS6	UCSFL207H1DS6	49	1.1
40	175	100	36	144	16	12	21	51.2	49.2	19	M14	<b>UCSFL208H1S6</b>	SFL208H1		UC208S6	24.8	14.3	14.0	UCSFL208H1CS6	UCSFL208H1DS6	56	1.5
45	188	108	38	148	19	13	22	52.2	49.2	19	M16	<b>UCSFL209H1S6</b>	SFL209H1		UC209S6	27.8	16.2	14.0	UCSFL209H1CS6	UCSFL209H1DS6	57	1.8
50	197	115	40	157	19	13	22	54.6	51.6	19	M16	<b>UCSFL210H1S6</b>	SFL210H1		UC210S6	29.8	18.6	14.4	UCSFL210H1CS6	UCSFL210H1DS6	59	2.1

[Remarks] 1) Applicable size of grease nipples is A-1/4-28UNF.

2) For more detailed information, refer to ball bearing for unit specification tables.

**Ball bearing units**  
**round-flanged type with spigot joint**  
**UCFC (with set screws)**

*d* 12 ~ 65 mm

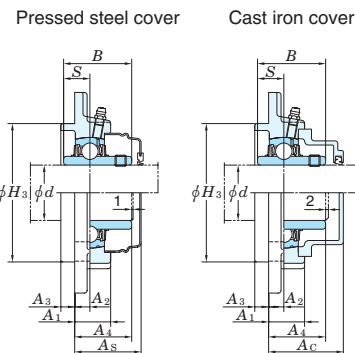
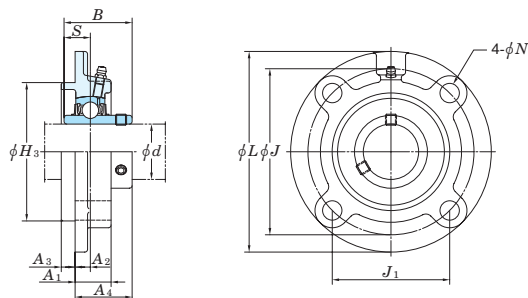

Tolerances for housing

unit : mm

housing No.	$\Delta H_{3s}$	$\Delta A_{2s}$	X	Y
FC204-FC206	0 -0.046	±0.5	0.7	0.2
FC207-FC210	0 -0.054			
FC211-FC217	0 -0.063	±0.8	1	0.3
FC218	0 -0.072			
FCX20				

$\Delta H_{3s}$  : deviation of spigot joint outside diameter.  
 $\Delta A_{2s}$  : deviation of distance from mounting face to centre of spherical bearing seating.  
 X : positional tolerance of bolt hole.  
 Y : circumferential runout tolerance of spigot joint in respect to axial line of spherical bearing seating.

Shaft dia. (mm) <i>d</i>	Dimensions (mm)												Bolt size	Unit No.	Housing No.	Applicable bearing			Unit No. with covers				Cover dimensions (mm)		(Refer.) Unit Mass (kg)	
	<i>L</i>	<i>H</i> <sub>3</sub>	<i>J</i>	<i>J</i> <sub>1</sub>	<i>N</i> ±0.2	<i>A</i> <sub>1</sub>	<i>A</i> <sub>2</sub>	<i>A</i> <sub>3</sub>	<i>A</i> <sub>4</sub>	<i>B</i>	<i>S</i>	No.				Basic load ratings (kN)		Factor	Pressed steel covers		Cast iron covers		<i>A</i> <sub>s</sub>	<i>A</i> <sub>c</sub>	Pressed steel covers	Cast iron covers
	<i>C</i> <sub>r</sub>	<i>C</i> <sub>0r</sub>	<i>f</i> <sub>0</sub>	Open ends	Closed end	Open ends	Closed end	<i>A</i> <sub>s</sub>	<i>A</i> <sub>c</sub>	Pressed steel covers	Cast iron covers															
12	100	62	78	55.1	12	20.5	10	5	28.3	31	12.7	M10	UCFC201	FC204	UC201	12.8	6.65	13.2	UCFC201C	UCFC201D	—	—	32	—	0.78	—
	15	100	62	78	55.1	12	20.5	10	5	28.3	31	12.7							M10	UCFC202	FC204	UC202	12.8	6.65	13.2	UCFC202C
17	100	62	78	55.1	12	20.5	10	5	28.3	31	12.7	M10	UCFC203	FC204	UC203	12.8	6.65	13.2	UCFC203C	UCFC203D	—	—	32	—	0.75	—
20	100	62	78	55.1	12	20.5	10	5	28.3	31	12.7	M10	UCFC204	FC204	UC204	12.8	6.65	13.2	UCFC204C	UCFC204D	UCFC204FC	UCFC204FD	32	38.5	0.73	0.84
	25	115	70	90	63.6	12	21	10	6	29.8	34.1	14.3							M10	UCFC205	FC205	UC205	14.0	7.85	13.9	UCFC205C
30	111	76	92	65	9.5	24	10	6	32.2	38.1	15.9	M8	UCFCX05	FCX05	UCX05	19.5	11.3	13.9	UCFCX05C	UCFCX05D	—	—	36	—	1.2	—
	127	85	105	74.2	12	22.5	8	9.5	33.4	42.9	17.5	M10							UCFC206	FC206	UC206	19.5	11.3	13.9	UCFC206C	UCFC206D
35	125	80	100	70.7	12	23	10	8	32.2	38.1	15.9	M10	UCFCX06	FCX06	UCX06	25.7	15.4	13.9	UCFCX06C	UCFCX06D	—	—	38	—	1.5	—
	133	92	111	78.5	12	26	9	11	39.2	49.2	19	M12							UCFC207	FC207	UC207	25.7	15.4	13.9	UCFC207C	UCFC207D
40	133	92	111	78.5	12	26	9	11	39.2	49.2	19	M10	UCFCX07	FCX07	UCX07	29.1	17.8	14.0	UCFCX07C	UCFCX07D	—	—	43	—	1.9	—
	145	100	120	84.8	14	26	11	10	41.2	49.2	19	M12							UCFC208	FC208	UC208	29.1	17.8	14.0	UCFC208C	UCFC208D
45	133	92	111	78.5	12	26	9	11	39.2	49.2	19	M10	UCFCX08	FCX08	UCX08	32.7	20.3	14.0	UCFCX08C	UCFCX08D	—	—	43	—	2.0	—
	155	108	130	91.9	14	25	8	12	40.6	51.6	19	M14							UCFC209	FC209	UC209	32.7	20.3	14.0	UCFC209C	UCFC209D
50	155	108	130	91.9	14	25	8	12	40.6	51.6	19	M12	UCFCX09	FCX09	UCX09	35.1	23.3	14.4	UCFCX09C	UCFCX09D	—	—	45	—	2.6	—
	165	110	138	97.6	16	28	10	12	42.6	51.6	19	M14							UCFC210	FC210	UC210	35.1	23.3	14.4	UCFC210C	UCFC210D
55	162	118	136	96.2	14	25	7	16	40.4	55.6	22.2	M12	UCFCX10	FCX10	UCX10	43.4	29.4	14.4	UCFCX10C	UCFCX10D	—	—	45	—	3.2	—
	185	125	150	106.1	19	31	13	12	46.4	55.6	22.2	M16							UCFC211	FC211	UC211	43.4	29.4	14.4	UCFC211C	UCFC211D
60	180	127	152	107.5	16	26	4	22	43.7	65.1	25.4	M14	UCFCX11	FCX11	UCX11	52.4	36.2	14.4	UCFCX11C	UCFCX11D	—	—	48	—	4.3	—
	195	135	160	113.1	19	36	17	12	56.7	65.1	25.4	M16							UCFC212	FC212	UC212	52.4	36.2	14.4	UCFC212C	UCFC212D
65	194	140	165	116.7	16	33	11	20	50.7	65.1	25.4	M14	UCFCX12	FCX12	UCX12	57.2	40.1	14.4	UCFCX12C	UCFCX12D	—	—	55	—	5.3	—
	205	145	170	120.2	19	36	16	14	55.7	65.1	25.4	M16							UCFC213	FC213	UC213	57.2	40.1	14.4	UCFC213C	UCFC213D
	194	140	165	116.7	16	33	11	20	55.4	74.6	30.2	M14	UCFCX13	FCX13	UCX13	62.2	44.1	14.5	UCFCX13C	UCFCX13D	—	—	60	—	5.7	—

[Remarks] 1) Applicable sizes of grease nipples are shown below.  
 A-1/4-28UNF..... 201~210, X05~X09  
 A-PT 1/8..... 211~218, X10~X20

2) For bearings with double- or triple-lip seals, unit and bearing number are suffixed by L2 or L3.  
 (UCFC206JL3, UC206L3)  
 3) For more detailed information, refer to ball bearing for unit specification tables.

**Ball bearing units**  
**round-flanged type with spigot joint**  
**UCFC (with set screws)**

*d* 70 ~ 100 mm

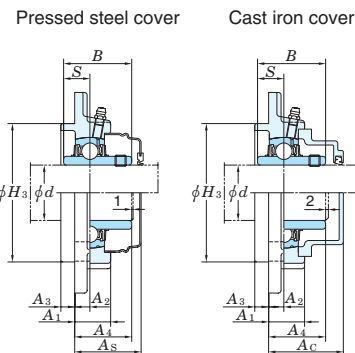
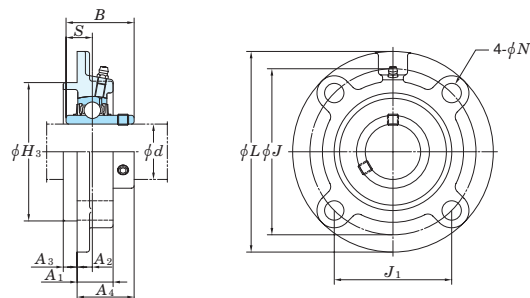

Tolerances for housing

unit : mm

housing No.	$\Delta H_{3s}$	$\Delta A_{2s}$	X	Y
FC204-FC206	0 -0.046	±0.5	0.7	0.2
FC207-FC210	0 -0.054			
FC211-FC217	0 -0.063	±0.8	1	0.3
FC218	0 -0.072			0.4

$\Delta H_{3s}$  : deviation of spigot joint outside diameter.  
 $\Delta A_{2s}$  : deviation of distance from mounting face to centre of spherical bearing seating.  
 X : positional tolerance of bolt hole.  
 Y : circumferential runout tolerance of spigot joint in respect to axial line of spherical bearing seating.

Shaft dia. (mm) <i>d</i>	Dimensions (mm)												Bolt size	Unit No.	Housing No.	Applicable bearing			Unit No. with covers				Cover dimensions (mm)		Unit Mass (kg)		
	<i>L</i>	<i>H</i> <sub>3</sub>	<i>J</i>	<i>J</i> <sub>1</sub>	<i>N</i> ±0.2	<i>A</i> <sub>1</sub>	<i>A</i> <sub>2</sub>	<i>A</i> <sub>3</sub>	<i>A</i> <sub>4</sub>	<i>B</i>	<i>S</i>	No.				Basic load ratings (kN)		Factor	Pressed steel covers		Cast iron covers		<i>A</i> <sub>s</sub>	<i>A</i> <sub>c</sub>	Pressed steel covers	Cast iron covers	
	<i>C<sub>r</sub></i>	<i>C<sub>0r</sub></i>	<i>f</i> <sub>0</sub>	Open ends	Closed end	Open ends	Closed end																				
<b>70</b>	215	150	177	125.1	19	40	17	14	61.4	74.6	30.2	M16	<b>UCFC214</b>	FC214		UC214	62.2	44.1	14.5	UCFC214C	UCFC214D	UCFC214FC	UCFC214FD	66	79	6.8	7.7
	222	164	190	134.3	19	36	14	20	58.5	77.8	33.3	M16	<b>UCFCX14</b>	FCX14		UCX14	67.4	48.3	14.5	UCFCX14C	UCFCX14D	—	—	63	—	7.3	—
<b>75</b>	220	160	184	130.1	19	40	18	16	62.5	77.8	33.3	M16	<b>UCFC215</b>	FC215		UC215	67.4	48.3	14.5	UCFC215C	UCFC215D	UCFC215FC	UCFC215FD	67	80	7.2	8.2
	222	164	190	134.3	19	35	12	22	61.3	82.6	33.3	M16	<b>UCFCX15</b>	FCX15		UCX15	72.7	53.0	14.6	UCFCX15C	UCFCX15D	—	—	66	—	8.0	—
<b>80</b>	240	170	200	141.4	23	42	18	16	67.3	82.6	33.3	M20	<b>UCFC216</b>	FC216		UC216	72.7	53.0	14.6	UCFC216C	UCFC216D	UCFC216FC	UCFC216FD	72	87	8.7	9.9
	260	186	219	154.8	23	36	10	25	61.6	85.7	34.1	M20	<b>UCFCX16</b>	FCX16		UCX16	84.0	61.9	14.5	UCFCX16C	UCFCX16D	—	—	66	—	11.3	—
<b>85</b>	250	180	208	147.1	23	45	18	18	69.6	85.7	34.1	M20	<b>UCFC217</b>	FC217		UC217	84.0	61.9	14.5	UCFC217C	UCFC217D	UCFC217FC	UCFC217FD	74	89	10.3	11.7
	260	186	219	154.8	23	36	10	25	66.3	96	39.7	M20	<b>UCFCX17</b>	FCX17		UCX17	96.1	71.5	14.5	UCFCX17C	UCFCX17D	—	—	71	—	12.9	—
<b>90</b>	265	190	220	155.5	23	50	22	18	78.3	96	39.7	M20	<b>UCFC218</b>	FC218		UC218	96.1	71.5	14.5	UCFC218C	UCFC218D	UCFC218FC	UCFC218FD	83	98	13.3	14.8
	260	186	219	154.8	23	43	12	28	73.1	104	42.9	M20	<b>UCFCX18</b>	FCX18		UCX18	109	81.9	14.4	—	—	UCFCX18C	UCFCX18D	—	92	13.5	15.4
<b>100</b>	276	206	238	168.3	23	66	22	28	90.3	117.5	49.2	M20	<b>UCFCX20</b>	FCX20		UCX20	133	105	14.4	—	—	UCFCX20C	UCFCX20D	—	116	18.2	20.7

[Remarks] 1) Applicable sizes of grease nipples are shown below.  
 A-1/4-28UNF ..... 201~210, X05~X09  
 A-PT 1/8 ..... 211~218, X10~X20

2) For bearings with double- or triple-lip seals, unit and bearing number are suffixed by L2 or L3.  
 (UCFC206JL3, UC206L3)  
 3) For more detailed information, refer to ball bearing for unit specification tables.

**Ball bearing units**  
**pressed steel round-flanged type**  
**SBPF (with set screws)**

*d* 12 ~ 35 mm

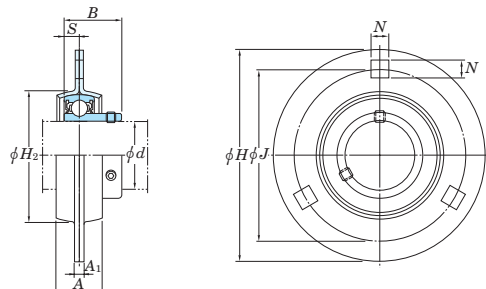

Shaft dia. (mm)	Dimensions (mm)								Bolt size	Unit No.	Housing No.	No.	Applicable bearing			(Refer.) Unit mass (kg)
	<i>H</i>	<i>A</i>	<i>A</i> <sub>1</sub>	<i>J</i> ±0.4	<i>N</i> ±0.25	<i>H</i> <sub>2</sub> <sup>1)</sup>	<i>B</i>	<i>S</i>					Basic load ratings (kN)		Factor	
<i>d</i>													<i>C</i> <sub>r</sub>	<i>C</i> <sub>0r</sub>	<i>f</i> <sub>0</sub>	
<b>12</b>	81	14	4	63.5	7.1	49	22	6	M6	<b>SBPF201</b>	PF203	SB201	9.55	4.80	13.2	0.27
<b>15</b>	81	14	4	63.5	7.1	49	22	6	M6	<b>SBPF202</b>	PF203	SB202	9.55	4.80	13.2	0.27
<b>17</b>	81	14	4	63.5	7.1	49	22	6	M6	<b>SBPF203</b>	PF203	SB203	9.55	4.80	13.2	0.27
<b>20</b>	90	16	4	71.5	9	55	25	7	M8	<b>SBPF204</b>	PF204	SB204	12.8	6.65	13.2	0.33
<b>25</b>	95	18	4	76	9	60	27	7.5	M8	<b>SBPF205</b>	PF205	SB205	14.0	7.85	13.9	0.38
<b>30</b>	113	19	5.2	90.5	11	71	30	8	M10	<b>SBPF206</b>	PF206	SB206	19.5	11.3	13.9	0.62
<b>35</b>	122	22	5.2	100	11	81	32	8.5	M10	<b>SBPF207</b>	PF207	SB207	25.7	15.4	13.9	0.82

[Note] 1) *H*<sub>2</sub> shows minimum dimension of mounting hole.

[Remark] For more detailed information, refer to ball bearing for unit specification tables.

**Ball bearing units**  
**pressed steel rhombic-flanged type**  
**SBPFL (with set screws)**

*d* 12 ~ 35 mm

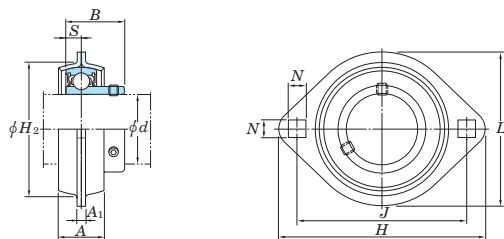

Shaft dia. (mm)	Dimensions (mm)									Bolt size	Unit No.	Housing No.	No.	Applicable bearing		Factor <i>f</i> <sub>0</sub>	(Refer.) Unit mass (kg)
	<i>H</i>	<i>L</i>	<i>A</i>	<i>A</i> <sub>1</sub>	<i>J</i> ±0.4	<i>N</i> ±0.25	<i>H</i> <sub>2</sub> <sup>1)</sup>	<i>B</i>	<i>S</i>					<i>C</i> <sub>r</sub>	<i>C</i> <sub>0r</sub>		
<b>12</b>	81	59	14	4	63.5	7.1	49	22	6	M6	<b>SBPFL201</b>	PFL203	SB201	9.55	4.80	13.2	0.19
<b>15</b>	81	59	14	4	63.5	7.1	49	22	6	M6	<b>SBPFL202</b>	PFL203	SB202	9.55	4.80	13.2	0.19
<b>17</b>	81	59	14	4	63.5	7.1	49	22	6	M6	<b>SBPFL203</b>	PFL203	SB203	9.55	4.80	13.2	0.19
<b>20</b>	90	67	16	4	71.5	9	55	25	7	M8	<b>SBPFL204</b>	PFL204	SB204	12.8	6.65	13.2	0.24
<b>25</b>	95	71	18	4	76	9	60	27	7.5	M8	<b>SBPFL205</b>	PFL205	SB205	14.0	7.85	13.9	0.28
<b>30</b>	113	84	19	5.2	90.5	11	71	30	8	M10	<b>SBPFL206</b>	PFL206	SB206	19.5	11.3	13.9	0.38
<b>35</b>	122	94	22	5.2	100	11	81	32	8.5	M10	<b>SBPFL207</b>	PFL207	SB207	25.7	15.4	13.9	0.66

[Note] 1) *H*<sub>2</sub> shows minimum dimension of mounting hole.

[Remark] For more detailed information, refer to ball bearing for unit specification tables.

**Ball bearing units**  
**take-up type**  
**UCT (with set screws)**  
*d* 12 ~ (55) mm

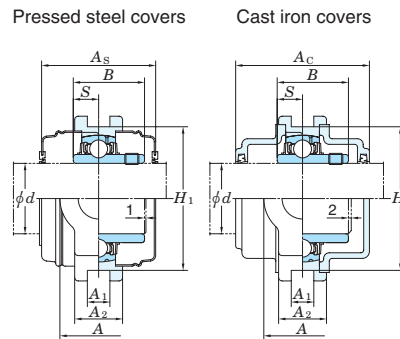
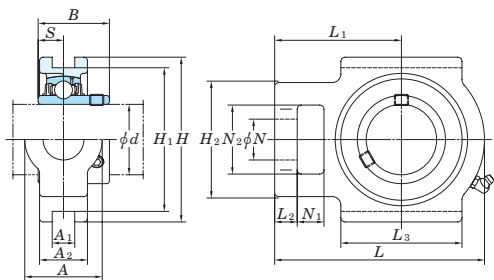

Tolerances for housing

housing No.			$\Delta A_{1s}$	$\Delta H_{1s}$	X
T204- T210	TX05- TX10	T305- T310	+0.2 0	0 -0.5	0.5
T211- T217	TX11- TX17	T311- T315	+0.3 0	0 -0.8	0.6
		T319- T322			0.7
		T324- T328			0.8

$\Delta A_{1s}$  : deviation of nominal raceway groove width.  
 $\Delta H_{1s}$  : deviation of distance between both groove bottoms.  
 X : symmetry tolerance of both groove-side face.

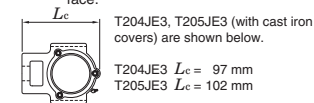

Shaft dia. (mm)	Dimensions (mm)															Unit No.	Housing No.	Applicable bearing			Unit No. with covers				Cover dimensions (mm)		(Refer.) Unit mass (kg)			
	<i>d</i>	A	A <sub>1</sub>	A <sub>2</sub>	H	H <sub>1</sub>	H <sub>2</sub>	L	L <sub>1</sub>	L <sub>2</sub>	L <sub>3</sub>	N	N <sub>1</sub>	N <sub>2</sub>	B			S	No.	Basic load ratings (kN)		Factor <i>f</i> <sub>0</sub>	Pressed steel covers		Cast iron covers		A <sub>s</sub>	A <sub>c</sub>	Pressed steel covers	Cast iron covers
																				<i>C</i> <sub>r</sub>	<i>C</i> <sub>0r</sub>		Open ends	Closed end	Open ends	Closed end				
12	32	12	21	89	76	51	94	61	10	51	19	16	32	31	12.7	UCT201	T204	UC201	12.8	6.65	13.2	UCT201C	UCT201CD	—	—	44	—	0.81	—	
	15	32	12	21	89	76	51	94	61	10	51	19	16	32	31	12.7	UCT202	T204	UC202	12.8	6.65	13.2	UCT202C	UCT202CD	—	—	44	—	0.79	—
	17	32	12	21	89	76	51	94	61	10	51	19	16	32	31	12.7	UCT203	T204	UC203	12.8	6.65	13.2	UCT203C	UCT203CD	—	—	44	—	0.78	—
20	32	12	21	89	76	51	94	61	10	51	19	16	32	31	12.7	UCT204	T204	UC204	12.8	6.65	13.2	UCT204C	UCT204CD	UCT204FC	UCT204FCD	44	62	0.76	1.1	
	25	32	12	24	89	76	51	97	62	10	51	19	16	32	34.1	14.3	UCT205	T205	UC205	14.0	7.85	13.9	UCT205C	UCT205CD	UCT205FC	UCT205FCD	48	66	0.84	1.2
		37	12	28	102	89	56	113	70	10	57	22	16	37	38.1	15.9	UCTX05	TX05	UCX05	19.5	11.3	13.9	UCTX05C	UCTX05CD	—	—	52	—	1.4	—
36		12	26	89	80	62	122	76	12	65	26	16	36	38	15	UCT305	T305	UC305	21.2	10.9	12.6	—	—	UCT305C	UCT305CD	—	76	1.4	2.0	
30	37	12	28	102	89	56	113	70	10	57	22	16	37	38.1	15.9	UCT206	T206	UC206	19.5	11.3	13.9	UCT206C	UCT206CD	UCT206FC	UCT206FCD	52	70	1.3	1.8	
	37	12	30	102	89	64	129	78	13	64	22	16	37	42.9	17.5	UCTX06	TX06	UCX06	25.7	15.4	13.9	UCTX06C	UCTX06CD	—	—	59	—	1.7	—	
	41	16	28	100	90	70	137	85	14	74	28	18	41	43	17	UCT306	T306	UC306	26.7	15.0	13.3	—	—	UCT306C	UCT306CD	—	82	1.8	2.4	
35	37	12	30	102	89	64	129	78	13	64	22	16	37	42.9	17.5	UCT207	T207	UC207	25.7	15.4	13.9	UCT207C	UCT207CD	UCT207FC	UCT207FCD	59	78	1.6	2.3	
	49	16	36	114	102	83	144	88	15	83	29	19	49	49.2	19	UCTX07	TX07	UCX07	29.1	17.8	14.0	UCTX07C	UCTX07CD	—	—	68	—	2.7	—	
	45	16	32	111	100	75	150	94	15	80	30	20	45	48	19	UCT307	T307	UC307	33.4	19.3	13.2	—	—	UCT307C	UCT307CD	—	88	2.3	3.1	
40	49	16	33	114	102	83	144	88	16	83	29	19	49	49.2	19	UCT208	T208	UC208	29.1	17.8	14.0	UCT208C	UCT208CD	UCT208FC	UCT208FCD	68	86	2.5	3.3	
	49	16	36	117	102	83	144	87	15	83	29	19	49	49.2	19	UCTX08	TX08	UCX08	32.7	20.3	14.0	UCTX08C	UCTX08CD	—	—	68	—	2.6	—	
	50	18	34	124	112	83	162	100	17	89	32	22	50	52	19	UCT308	T308	UC308	40.7	24.0	13.2	—	—	UCT308C	UCT308CD	—	96	3.0	4.0	
45	49	16	35	117	102	83	144	87	16	83	29	19	49	49.2	19	UCT209	T209	UC209	32.7	20.3	14.0	UCT209C	UCT209CD	UCT209FC	UCT209FCD	68	88	2.4	3.2	
	49	16	38	117	102	83	149	90	16	86	29	19	49	51.6	19	UCTX09	TX09	UCX09	35.1	23.3	14.4	UCTX09C	UCTX09CD	—	—	73	—	2.9	—	
	55	18	38	138	125	90	178	110	18	97	34	24	55	57	22	UCT309	T309	UC309	48.9	29.5	13.3	—	—	UCT309C	UCT309CD	—	102	4.1	5.4	
50	49	16	37	117	102	83	149	90	16	86	29	19	49	51.6	19	UCT210	T210	UC210	35.1	23.3	14.4	UCT210C	UCT210CD	UCT210FC	UCT210FCD	73	97	2.6	3.6	
	64	22	42	146	130	102	171	106	19	95	35	25	64	55.6	22.2	UCTX10	TX10	UCX10	43.4	29.4	14.4	UCTX10C	UCTX10CD	—	—	75	—	4.4	—	
	61	20	40	151	140	98	191	117	20	106	37	27	61	61	22	UCT310	T310	UC310	62.0	38.3	13.2	—	—	UCT310C	UCT310CD	—	110	4.9	6.5	
55	64	22	38	146	130	102	171	106	19	95	35	25	64	55.6	22.2	UCT211	T211	UC211	43.4	29.4	14.4	UCT211C	UCT211CD	UCT211FC	UCT211FCD	75	99	4.0	5.2	

[Remarks] 1) Applicable sizes of grease nipples are shown below.  
 B-1/4-28UNF..... 201~210, X05~X09, 305~308  
 B-PT 1/8 ..... 211~217, X10~X17, 309~328

2) For bearings with double- or triple-lip seals, unit and bearing number are suffixed by L2 or L3.  
 (UCT206JL3, UC206L3)  
 3) For more detailed information, refer to ball bearing for unit specification tables.

**Ball bearing units**  
**take-up type**  
**UCT (with set screws)**  
*d* (55) ~ 100 mm

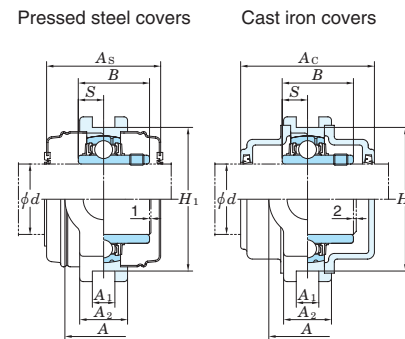
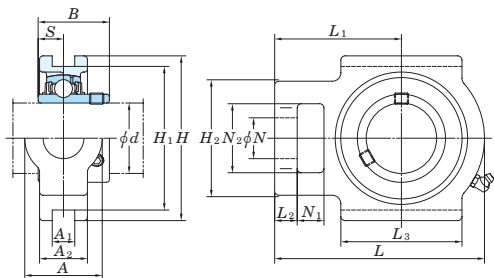

Tolerances for housing

housing No.			$\Delta A_{1s}$	$\Delta H_{1s}$	X
T204- T210	TX05- TX10	T305- T310	+0.2 0	0 -0.5	0.5
T211- T217	TX11- TX17	T311- T318	+0.3 0	0 -0.8	0.6
		T319- T322			0.7
		T324- T328			0.8

$\Delta A_{1s}$  : deviation of nominal raceway groove width.  
 $\Delta H_{1s}$  : deviation of distance between both groove bottoms.  
 X : symmetry tolerance of both groove-side face.

Shaft dia. (mm) <i>d</i>	Dimensions (mm)															Unit No.	Housing No.	Applicable bearing			Unit No. with covers				Cover dimensions (mm)		(Refer.) Unit mass (kg)		
	A	A <sub>1</sub>	A <sub>2</sub>	H	H <sub>1</sub>	H <sub>2</sub>	L	L <sub>1</sub>	L <sub>2</sub>	L <sub>3</sub>	N	N <sub>1</sub>	N <sub>2</sub>	B	S			No.	Basic load ratings (kN) <i>C<sub>r</sub></i>	<i>C<sub>0r</sub></i>	Factor <i>f<sub>0</sub></i>	Pressed steel covers		Cast iron covers		A <sub>s</sub>	A <sub>c</sub>	Pressed steel covers	Cast iron covers
	Open ends	Closed end	Open ends	Closed end	Open ends	Closed end	Open ends	Closed end	Open ends	Closed end	Open ends	Closed end	Open ends	Closed end	Open ends			Closed end	Open ends	Closed end	Open ends	Closed end	Open ends	Closed end	Open ends	Closed end			
55	64	22	44	146	130	102	194	119	19	102	35	32	64	65.1	25.4	UCTX11	TX11	UCX11	52.4	36.2	14.4	UCTX11C	UCTX11CD	—	—	88	—	5.3	—
	66	22	44	163	150	105	207	127	21	115	39	29	66	66	25	UCT311	T311	UC311	71.6	45.0	13.2	—	—	UCT311C	UCT311CD	—	114	6.1	7.9
60	64	22	42	146	130	102	194	119	19	102	35	32	64	65.1	25.4	UCT212	T212	UC212	52.4	36.2	14.4	UCT212C	UCT212CD	UCT212FC	UCT212FCD	88	114	4.9	6.4
	70	26	48	167	151	111	224	137	21	121	41	32	70	65.1	25.4	UCTX12	TX12	UCX12	57.2	40.1	14.4	UCTX12C	UCTX12CD	—	—	88	—	7.4	—
	71	22	46	178	160	113	220	135	23	123	41	31	71	71	26	UCT312	T312	UC312	81.9	52.2	13.2	—	—	UCT312C	UCT312CD	—	124	7.6	9.9
65	70	26	44	167	151	111	224	137	21	121	41	32	70	65.1	25.4	UCT213	T213	UC213	57.2	40.1	14.4	UCT213C	UCT213CD	UCT213FC	UCT213FCD	88	114	6.9	8.6
	70	26	48	167	151	111	224	137	21	121	41	32	70	74.6	30.2	UCTX13	TX13	UCX13	62.2	44.1	14.5	UCTX13C	UCTX13CD	—	—	98	—	7.6	—
	80	26	50	190	170	116	238	146	25	134	43	32	70	75	30	UCT313	T313	UC313	92.7	59.9	13.2	—	—	UCT313C	UCT313CD	—	122	9.3	11.4
70	70	26	46	167	151	111	224	137	21	121	41	32	70	74.6	30.2	UCT214	T214	UC214	62.2	44.1	14.5	UCT214C	UCT214CD	UCT214FC	UCT214FCD	98	124	7.0	8.9
	70	26	48	167	151	111	232	140	21	121	41	32	70	77.8	33.3	UCTX14	TX14	UCX14	67.4	48.3	14.5	UCTX14C	UCTX14CD	—	—	98	—	7.9	—
	90	26	52	202	180	130	252	155	25	140	46	36	85	78	33	UCT314	T314	UC314	104	68.2	13.2	—	—	UCT314C	UCT314CD	—	124	11.1	13.4
75	70	26	48	167	151	111	232	140	21	121	41	32	70	77.8	33.3	UCT215	T215	UC215	67.4	48.3	14.5	UCT215C	UCT215CD	UCT215FC	UCT215FCD	98	124	7.3	9.2
	70	28	48	184	165	111	235	140	21	121	41	32	70	82.6	33.3	UCTX15	TX15	UCX15	72.7	53.0	14.6	UCTX15C	UCTX15CD	—	—	108	—	8.7	—
	90	26	55	216	192	132	262	160	25	150	46	36	85	82	32	UCT315	T315	UC315	113	77.2	13.2	—	—	UCT315C	UCT315CD	—	134	13.0	15.5
80	70	26	51	184	165	111	235	140	21	121	41	32	70	82.6	33.3	UCT216	T216	UC216	72.7	53.0	14.6	UCT216C	UCT216CD	UCT216FC	UCT216FCD	108	138	8.2	10.6
	73	28	54	198	173	124	260	162	28	157	48	38	73	85.7	34.1	UCTX16	TX16	UCX16	84.0	61.9	14.5	UCTX16C	UCTX16CD	—	—	112	—	11.7	—
	102	30	60	230	204	150	282	174	28	160	53	42	98	86	34	UCT316	T316	UC316	123	86.7	13.3	—	—	UCT316C	UCT316CD	—	138	16.2	19.1
85	73	30	54	198	173	124	260	162	29	157	48	38	73	85.7	34.1	UCT217	T217	UC217	84.0	61.9	14.5	UCT217C	UCT217CD	UCT217FC	UCT217FCD	112	142	11.0	13.7
	73	28	54	198	173	124	260	162	28	157	48	38	73	96	39.7	UCTX17	TX17	UCX17	96.1	71.5	14.5	UCTX17C	UCTX17CD	—	—	122	—	11.7	—
	102	32	64	240	214	152	298	183	30	170	53	42	98	96	40	UCT317	T317	UC317	133	96.8	13.3	—	—	UCT317C	UCT317CD	—	146	19.0	22.3
90	110	32	66	255	228	160	312	192	30	175	57	46	106	96	40	UCT318	T318	UC318	143	107	13.3	—	—	UCT318C	UCT318CD	—	150	21.6	25.4
95	110	35	72	270	240	165	322	197	31	180	57	46	106	103	41	UCT319	T319	UC319	153	119	13.3	—	—	UCT319C	UCT319CD	—	162	24.9	29.2
100	120	35	75	290	260	175	345	210	32	200	59	48	115	108	42	UCT320	T320	UC320	173	141	13.2	—	—	UCT320C	UCT320CD	—	174	30.7	36.3

(Remarks) 1) Applicable sizes of grease nipples are shown below.  
 B-1/4-28UNF..... 201-210, X05-X09, 305-308  
 B-PT 1/8..... 211-217, X10-X17, 309-328

2) For bearings with double- or triple-lip seals, unit and bearing number are suffixed by L2 or L3.  
 (UCT206JL3, UC206L3)  
 3) For more detailed information, refer to ball bearing for unit specification tables.



**Ball bearing units**  
**take-up type**  
**UCT (with set screws)**

*d* 105 ~ 140 mm

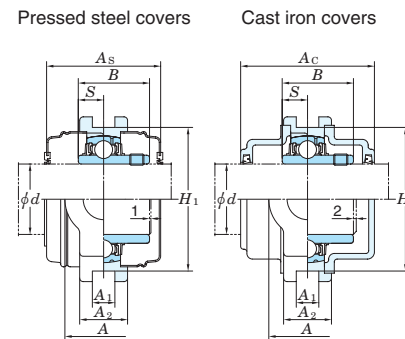
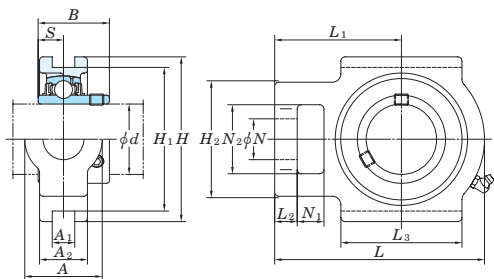

Tolerances for housing

housing No.			unit : mm		
			$\Delta A_{1s}$	$\Delta H_{1s}$	X
T204- T210	TX05- TX10	T305- T310	+0.2 0	0 -0.5	0.5
T211- T217	TX11- TX17	T311- T318			0.6
		T319- T322	+0.3 0	0 -0.8	0.7
		T324- T328			0.8

$\Delta A_{1s}$  : deviation of nominal raceway groove width.  
 $\Delta H_{1s}$  : deviation of distance between both groove bottoms.  
 X : symmetry tolerance of both groove-side face.

Shaft dia. (mm)	Dimensions (mm)															Unit No.	Housing No.	Applicable bearing			Unit No. with covers				Cover dimensions (mm)		(Refer.) Unit mass (kg)			
	<i>d</i>	A	A <sub>1</sub>	A <sub>2</sub>	H	H <sub>1</sub>	H <sub>2</sub>	L	L <sub>1</sub>	L <sub>2</sub>	L <sub>3</sub>	N	N <sub>1</sub>	N <sub>2</sub>	B			S	No.	Basic load ratings (kN)		Factor <i>f</i> <sub>0</sub>	Pressed steel covers		Cast iron covers		A <sub>s</sub>	A <sub>c</sub>	Pressed steel covers	Cast iron covers
																				C <sub>r</sub>	C <sub>0r</sub>		Open ends	Closed end	Open ends	Closed end				
<b>105</b>	120	35	75	290	260	175	345	210	32	200	59	48	115	112	44	<b>UCT321</b>	T321	UC321	184	153	13.2	—	—	UCT321C	UCT321CD	—	178	36.7	42.7	
<b>110</b>	130	38	80	320	285	185	385	235	38	215	65	52	125	117	46	<b>UCT322</b>	T322	UC322	205	180	13.2	—	—	UCT322C	UCT322CD	—	188	39.7	46.5	
<b>120</b>	140	45	90	355	320	210	432	267	42	230	70	60	140	126	51	<b>UCT324</b>	T324	UC324	207	185	13.5	—	—	UCT324C	UCT324CD	—	196	54.4	63.9	
<b>130</b>	150	50	100	385	350	220	465	285	45	240	75	65	150	135	54	<b>UCT326</b>	T326	UC326	229	214	13.6	—	—	UCT326C	UCT326CD	—	214	69.3	81.4	
<b>140</b>	155	50	100	415	380	230	515	315	50	255	80	70	160	145	59	<b>UCT328</b>	T328	UC328	253	246	13.6	—	—	UCT328C	UCT328CD	—	222	85.1	101	

[Remarks] 1) Applicable sizes of grease nipples are shown below.  
 B-1/4-28UNF..... 201~210, X05~X09, 305~308  
 B-PT 1/8..... 211~217, X10~X17, 309~328

2) For bearings with double- or triple-lip seals, unit and bearing number are suffixed by L2 or L3.  
 (UCT206JL3, UC206L3)  
 3) For more detailed information, refer to ball bearing for unit specification tables.

**Ball bearing units  
cartridge type  
UCC (with set screws)**

*d* 12 ~ 50 mm

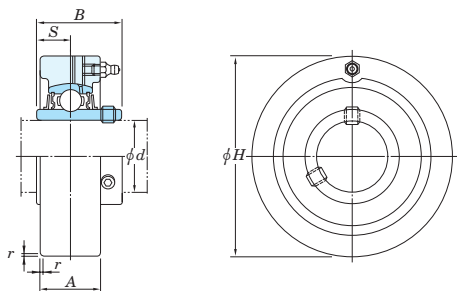

Shaft dia. (mm) <i>d</i>	Dimensions (mm)					Unit No.	Housing No.	No.	Applicable bearing		Factor <i>f</i> <sub>0</sub>	(Refer.) Unit mass (kg)
	<i>H</i>	<i>A</i>	<i>r</i>	<i>B</i>	<i>S</i>				<i>C</i> <sub>r</sub>	<i>C</i> <sub>0r</sub>		
12	72	20	1.5	31	12.7	UCC201	C204	UC201	12.8	6.65	13.2	0.52
15	72	20	1.5	31	12.7	UCC202	C204	UC202	12.8	6.65	13.2	0.50
17	72	20	1.5	31	12.7	UCC203	C204	UC203	12.8	6.65	13.2	0.49
20	72	20	1.5	31	12.7	UCC204	C204	UC204	12.8	6.65	13.2	0.47
25	80	22	1.5	34.1	14.3	UCC205	C205	UC205	14.0	7.85	13.9	0.64
	90	27	1.5	38.1	15.9	UCCX05	CX05	UCX05	19.5	11.3	13.9	1.0
	90	26	2	38	15	UCC305	C305	UC305	21.2	10.9	12.6	1.5
30	85	27	1.5	38.1	15.9	UCC206	C206	UC206	19.5	11.3	13.9	0.81
	100	30	2	42.9	17.5	UCCX06	CX06	UCX06	25.7	15.4	13.9	1.3
	100	28	2	43	17	UCC306	C306	UC306	26.7	15.0	13.3	1.7
35	90	28	2	42.9	17.5	UCC207	C207	UC207	25.7	15.4	13.9	0.93
	110	34	2	49.2	19	UCCX07	CX07	UCX07	29.1	17.8	14.0	1.7
	110	32	3	48	19	UCC307	C307	UC307	33.4	19.3	13.2	2.2
40	100	30	2	49.2	19	UCC208	C208	UC208	29.1	17.8	14.0	1.2
	120	38	2	49.2	19	UCCX08	CX08	UCX08	32.7	20.3	14.0	2.3
	120	34	3	52	19	UCC308	C308	UC308	40.7	24.0	13.2	2.2
45	110	31	2	49.2	19	UCC209	C209	UC209	32.7	20.3	14.0	1.5
	120	38	2	51.6	19	UCCX09	CX09	UCX09	35.1	23.3	14.4	2.3
	130	38	3	57	22	UCC309	C309	UC309	48.9	29.5	13.3	2.8
50	120	33	2	51.6	19	UCC210	C210	UC210	35.1	23.3	14.4	2.0
	130	40	2.5	55.6	22.2	UCCX10	CX10	UCX10	43.4	29.4	14.4	2.8
	140	40	3	61	22	UCC310	C310	UC310	62.0	38.3	13.2	3.2

- [Remarks] 1) Applicable sizes of grease nipples are shown below.  
A-1/4-28UNF ..... 201~213, X05~X12, 305~308  
A-PT 1/8 ..... 309~328  
2) For bearings with double- or triple-lip seals, unit and bearing number are suffixed by L2 or L3.  
(UCC206JL3, UC206L3)  
3) For more detailed information, refer to ball bearing for unit specification tables.

*d* 55 ~ 130 mm

Tolerances for housing

unit : mm

housing No.	$\Delta H_s$	$\Delta A_s$	Y
C204- C205	0 -0.030		
C206- C210	CX05- CX08	C305- C308	±0.2
	CX09- CX10	C309- C310	
C211- C213	CX11- CX12	C311- C314	±0.3
	C315- C318		
	C319		
	C320- C322		±0.4
	C324- C326		

$\Delta H_s$  : deviation of outside diameter.  
 $\Delta A_s$  : deviation of width.  
Y : circumferential runout tolerances of outside diameter in respect to shaft straight line of spherical bearing seating.

Shaft dia. (mm) <i>d</i>	Dimensions (mm)					Unit No.	Housing No.	No.	Applicable bearing		Factor <i>f</i> <sub>0</sub>	(Refer.) Unit mass (kg)
	<i>H</i>	<i>A</i>	<i>r</i>	<i>B</i>	<i>S</i>				<i>C</i> <sub>r</sub>	<i>C</i> <sub>0r</sub>		
55	125	35	2.5	55.6	22.2	UCC211	C211	UC211	43.4	29.4	14.4	2.2
	150	42	2.5	65.1	25.4	UCCX11	CX11	UCX11	52.4	36.2	14.4	4.0
	150	44	3	66	25	UCC311	C311	UC311	71.6	45.0	13.2	3.9
60	130	38	2.5	65.1	25.4	UCC212	C212	UC212	52.4	36.2	14.4	2.6
	160	44	2.5	65.1	25.4	UCCX12	CX12	UCX12	57.2	40.1	14.4	4.6
	160	46	3	71	26	UCC312	C312	UC312	81.9	52.2	13.2	4.8
65	140	40	2.5	65.1	25.4	UCC213	C213	UC213	57.2	40.1	14.4	3.0
	170	50	3	75	30	UCC313	C313	UC313	92.7	59.9	13.2	5.7
70	180	52	3	78	33	UCC314	C314	UC314	104	68.2	13.2	6.7
75	190	55	4	82	32	UCC315	C315	UC315	113	77.2	13.2	7.8
80	200	60	4	86	34	UCC316	C316	UC316	123	86.7	13.3	9.2
85	215	64	4	96	40	UCC317	C317	UC317	133	96.8	13.3	11.7
90	225	66	4	96	40	UCC318	C318	UC318	143	107	13.3	13.1
95	240	72	4	103	41	UCC319	C319	UC319	153	119	13.3	15.8
100	260	75	4	108	42	UCC320	C320	UC320	173	141	13.2	19.6
105	260	75	4	112	44	UCC321	C321	UC321	184	153	13.2	27.0
110	300	80	5	117	46	UCC322	C322	UC322	205	180	13.2	29.2
120	320	90	5	126	51	UCC324	C324	UC324	207	185	13.5	35.9
130	340	100	6	135	54	UCC326	C326	UC326	229	214	13.6	43.0

**Ball bearing units  
cartridge type  
UCC (with set screws)**

*d* 140 mm

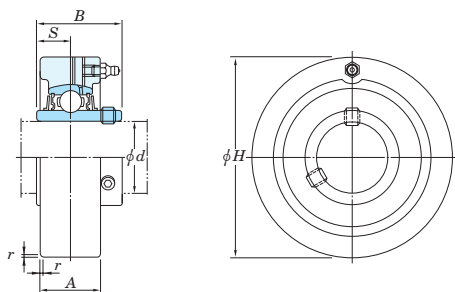

Shaft dia. (mm) <i>d</i>	Dimensions (mm)					Unit No.	Housing No.	No.	Applicable bearing		Factor <i>f</i> <sub>0</sub>	(Refer.) Unit mass (kg)
	<i>H</i>	<i>A</i>	<i>r</i>	<i>B</i>	<i>S</i>				Basic load ratings (kN)			
<b>140</b>	360	100	6	145	59	<b>UCC328</b>	C328	UC328	253	246	13.6	52.9

- [Remarks]
- Applicable sizes of grease nipples are shown below.  
 A-1/4-28UNF ..... 201~213, X05~X12, 305~308  
 A-PT 1/8 ..... 309~328
  - For bearings with double- or triple-lip seals, unit and bearing number are suffixed by L2 or L3.  
 (UCC206JL3, UC206L3)
  - For more detailed information, refer to ball bearing for unit specification tables.

Tolerances for housing

unit : mm

housing No.			$\Delta H_s$	$\Delta A_s$	Y
C204- C205			0 -0.030	±0.2	0.2
C206- C210	CX05- CX08	C305- C308	0 -0.035		
	CX09- CX10	C309- C310	0	±0.3	0.3
C211- C213	CX11- CX12	C311- C314	-0.040		
		C315- C318 C319	0 -0.046		
		C320- C322	0 -0.052	±0.4	0.4
		C324- C326	0 -0.057		

$\Delta H_s$  : deviation of outside diameter.  
 $\Delta A_s$  : deviation of width.  
 Y : circumferential runout tolerances  
 of outside diameter in respect to  
 shaft straight line of spherical  
 bearing seating.

**Ball bearings for units**  
**cylindrical bore type (with set screws)**

$d$  8 ~ (35) mm

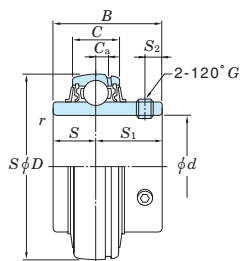

UC

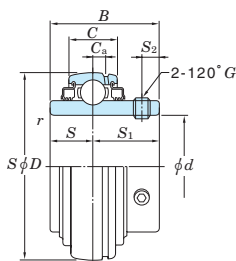

UC-L3

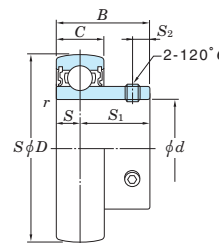

SB

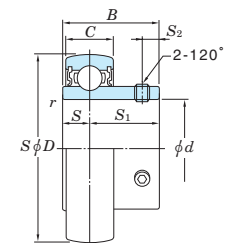

SU

Shaft dia. (mm) $d$	Boundary dimensions (mm)				Basic load ratings (kN)		Factor $f_0$	Bearing No.		Dimensions (mm)				Set screw size $G$	(Refer.) Mass (kg)	
	$D$	$B$	$C$	$r$ min.	$C_r$	$C_{0r}$		With standard seals	With triple-lip seals	$C_a$	$S$	$S_1$	$S_2$			
8	22	12	7	0.3	3.27	1.37	12.4	SU08	—	—	3.5	8.5	2.8	M3×0.35	0.012	
10	26	15	8	0.3	4.55	1.95	12.3	SU000	—	—	5	10	3	M3×0.35	0.024	
12	28	15	8	0.3	5.10	2.40	13.2	SU001	—	—	5	10	3	M3×0.35	0.026	
	40	22	12	0.6	9.55	4.80	13.2	SB201	—	—	6	16	4	M5×0.5	0.10	
	47	31	16	0.6	12.8	6.65	13.2	UC201	UC201L2	4	12.7	18.3	5	M6×0.75	0.21	
15	32	16.5	9	0.3	5.60	2.85	13.9	SU002	—	—	5.5	11	3.3	M4×0.5	0.038	
	40	22	12	0.6	9.55	4.80	13.2	SB202	—	—	6	16	4	M5×0.5	0.10	
	47	31	16	0.6	12.8	6.65	13.2	UC202	UC202L2	4	12.7	18.3	5	M6×0.75	0.19	
17	35	17.5	10	0.3	6.00	3.25	14.4	SU003	—	—	6	11.5	3.3	M4×0.5	0.050	
	40	22	12	0.6	9.55	4.80	13.2	SB203	—	—	6	16	4	M5×0.5	0.10	
	47	31	16	0.6	12.8	6.65	13.2	UC203	UC203L2	4	12.7	18.3	5	M6×0.75	0.18	
20	42	21	12	0.6	9.40	5.05	13.9	SU004	—	—	7	14	4	M5×0.5	0.080	
	47	25	14	1	12.8	6.65	13.2	SB204	—	—	7	18	5	M6×0.75	0.15	
	47	31	16	1	12.8	6.65	13.2	UC204	UC204L2	4	12.7	18.3	5	M6×0.75	0.16	
25	47	22	12	0.6	10.1	5.85	14.5	SU005	—	—	7	15	4.5	M5×0.5	0.10	
	52	27	15	1	14.0	7.85	13.9	SB205	—	—	7.5	19.5	5.5	M6×0.75	0.18	
	52	34.1	17	1	14.0	7.85	13.9	UC205	UC205L2	3.5	14.3	19.8	5.5	M6×0.75	0.20	
	62	38	22	1.1	21.2	10.9	13.2	UC305	—	—	5	15	23	6	M6×0.75	0.45
30	62	38.1	19	1	19.5	11.3	13.9	UCX05	UCX05L3	4.5	15.9	22.2	6	M6×0.75	0.39	
	55	24.5	13	1	13.2	8.25	14.7	SU006	—	—	7.5	17	5.5	M5×0.5	0.15	
	62	30	16	1	19.5	11.3	13.9	SB206	—	—	8	22	6	M6×0.75	0.27	
	62	38.1	19	1	19.5	11.3	13.9	UC206	UC206L3	4.5	15.9	22.2	6	M6×0.75	0.32	
35	72	42.9	20	1	25.7	15.4	13.9	UCX06	UCX06L3	4.5	17.5	25.4	6.5	M8×1	0.58	
	72	43	24	1.1	26.7	15.0	13.3	UC306	—	—	5.5	17	26	6	M6×0.75	0.56
	72	32	17	1.1	25.7	15.4	13.9	SB207	—	—	8.5	23.5	6	M6×0.75	0.42	

[Remarks] 1) SU type bearings are ball bearings for compact series units.  
2) UC201 to UC205 are with double-lip seals.

**Ball bearings for units**  
**cylindrical bore type (with set screws)**

*d* (35) ~ (75) mm

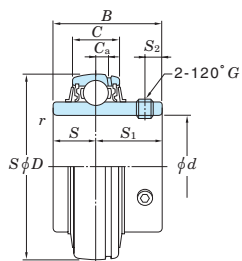

UC

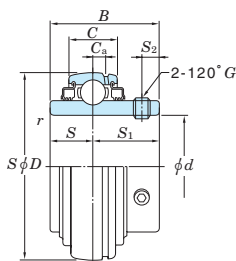

UC-L3

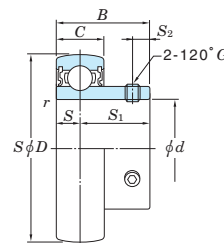

SB

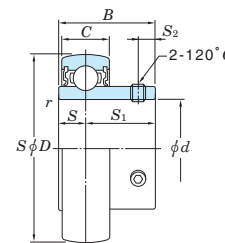

SU

Shaft dia. (mm) <i>d</i>	Boundary dimensions (mm)				Basic load ratings (kN)		Factor <i>f</i> <sub>0</sub>	Bearing No.		Dimensions (mm)				Set screw size <i>G</i>	(Refer.) Mass (kg)
	<i>D</i>	<i>B</i>	<i>C</i>	<i>r</i> min.	<i>C</i> <sub>r</sub>	<i>C</i> <sub>0r</sub>		With standard seals	With triple-lip seals	<i>C</i> <sub>a</sub>	<i>S</i>	<i>S</i> <sub>1</sub>	<i>S</i> <sub>2</sub>		
35	72	42.9	20	1.1	25.7	15.4	13.9	UC207	UC207L3	4.5	17.5	25.4	6.5	M8×1	0.48
	80	48	26	1.5	33.4	19.3	13.2	UC307	UC307L3	5.5	19	29	8	M8×1	0.71
	80	49.2	21	1.1	29.1	17.8	14.0	UCX07	UCX07L3	4.5	19	30.2	8	M8×1	0.75
40	80	34	18	1.1	29.1	17.8	14.0	SB208	—	—	9	25	8	M8×1	0.60
	80	49.2	21	1.1	29.1	17.8	14.0	UC208	UC208L3	4.5	19	30.2	8	M8×1	0.64
	85	49.2	22	1.1	32.7	20.3	14.0	UCX08	UCX08L3	5	19	30.2	8	M8×1	0.83
	90	52	28	1.5	40.7	24.0	13.2	UC308	UC308L3	6	19	33	10	M10×1.25	1.00
45	85	49.2	22	1.1	32.7	20.3	14.0	UC209	UC209L3	5	19	30.2	8	M8×1	0.68
	90	51.6	24	1.1	35.1	23.3	14.4	UCX09	UCX09L3	6	19	32.6	9	M10×1.25	0.95
	100	57	30	1.5	48.9	29.5	13.3	UC309	UC309L3	6.5	22	35	10	M10×1.25	1.33
50	90	51.6	24	1.1	35.1	23.3	14.4	UC210	UC210L3	6	19	32.6	9	M10×1.25	0.80
	100	55.6	25	1.1	43.4	29.4	14.4	UCX10	UCX10L3	5.5	22.2	33.4	9	M10×1.25	1.29
	110	61	32	2	62.0	38.3	13.2	UC310	UC310L3	7	22	39	12	M12×1.5	1.69
55	100	55.6	25	1.5	43.4	29.4	14.4	UC211	UC211L3	5.5	22.2	33.4	9	M10×1.25	1.11
	110	65.1	27	1.5	52.4	36.2	14.4	UCX11	UCX11L3	6	25.4	39.7	10.5	M10×1.25	1.80
	120	66	34	2	71.6	45.0	13.2	UC311	UC311L3	7	25	41	12	M12×1.5	1.90
60	110	65.1	27	1.5	52.4	36.2	14.4	UC212	UC212L3	6	25.4	39.7	10.5	M10×1.25	1.54
	120	65.1	28	1.5	57.2	40.1	14.4	UCX12	UCX12L3	6.5	25.4	39.7	12	M12×1.5	2.05
	130	71	36	2.1	81.9	52.2	13.2	UC312	UC312L3	6.5	26	45	12	M12×1.5	2.60
65	120	65.1	28	1.5	57.2	40.1	14.4	UC213	UC213L3	6.5	25.4	39.7	12	M12×1.5	1.86
	125	74.6	30	1.5	62.2	44.1	14.5	UCX13	UCX13L3	6	30.2	44.4	12	M12×1.5	2.52
	140	75	38	2.1	92.7	59.9	13.2	UC313	UC313L3	7	30	45	12	M12×1.5	3.16
70	125	74.6	30	1.5	62.2	44.1	14.5	UC214	UC214L3	6	30.2	44.4	12	M12×1.5	2.05
	130	77.8	32	1.5	67.4	48.3	14.5	UCX14	UCX14L3	7	33.3	44.5	12	M12×1.5	2.74
	150	78	40	2.1	104	68.2	13.2	UC314	UC314L3	7.5	33	45	12	M12×1.5	3.90
75	130	77.8	32	1.5	67.4	48.3	14.5	UC215	UC215L3	7	33.3	44.5	12	M12×1.5	2.21

**Ball bearings for units**  
**cylindrical bore type (with set screws)**

$d$  (75) ~ 140 mm

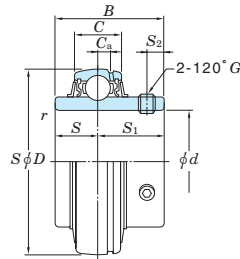

UC

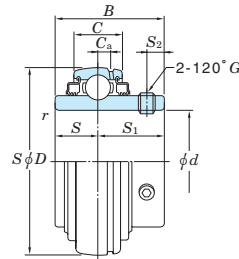

UC-L3

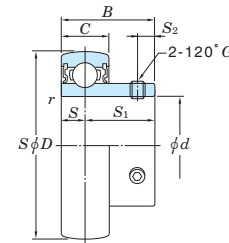

SB

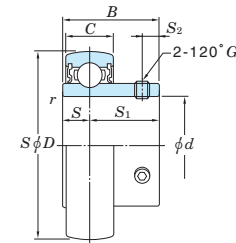

SU

Shaft dia. (mm) $d$	Boundary dimensions (mm)				Basic load ratings (kN)		Factor $f_0$	Bearing No.		Dimensions (mm)				Set screw size $G$	(Refer.) Mass (kg)
	$D$	$B$	$C$	$r_{min.}$	$C_r$	$C_{0r}$		With standard seals	With triple-lip seals	$C_a$	$S$	$S_1$	$S_2$		
75	140	82.6	33	1.5	72.7	53.0	14.6	<b>UCX15</b>	<b>UCX15L3</b>	7.5	33.3	49.3	14	M12×1.5	3.41
	160	82	42	2.1	113	77.2	13.2	<b>UC315</b>	<b>UC315L3</b>	6.5	32	50	14	M14×1.5	4.70
80	140	82.6	33	2	72.7	53.0	14.6	<b>UC216</b>	<b>UC216L3</b>	7.5	33.3	49.3	14	M12×1.5	2.79
	150	85.7	35	2	84.0	61.9	14.5	<b>UCX16</b>	<b>UCX16L3</b>	7.5	34.1	51.6	14	M12×1.5	3.87
	170	86	44	2.1	123	86.7	13.3	<b>UC316</b>	<b>UC316L3</b>	7	34	52	14	M14×1.5	5.60
85	150	85.7	35	2	84.0	61.9	14.5	<b>UC217</b>	<b>UC217L3</b>	7.5	34.1	51.6	14	M12×1.5	3.45
	160	96	38	2	96.1	71.5	14.5	<b>UCX17</b>	<b>UCX17L3</b>	8	39.7	56.3	15	M12×1.5	5.05
	180	96	46	3	133	96.8	13.3	<b>UC317</b>	<b>UC317L3</b>	8	40	56	16	M16×1.5	6.90
90	160	96	38	2	96.1	71.5	14.5	<b>UC218</b>	<b>UC218L3</b>	8	39.7	56.3	15	M12×1.5	4.35
	170	104	40	2	109	81.9	14.4	<b>UCX18</b>	—	8.5	42.9	61.1	16	M14×1.5	6.00
	190	96	48	3	143	107	13.3	<b>UC318</b>	<b>UC318L3</b>	8.5	40	56	16	M16×1.5	7.87
95	200	103	50	3	153	119	13.3	<b>UC319</b>	<b>UC319L3</b>	8.5	41	62	18	M16×1.5	8.91
100	190	117.5	43	2.1	133	105	14.4	<b>UCX20</b>	—	8.5	49.2	68.3	18	M16×1.5	8.56
	215	108	54	3	173	141	13.2	<b>UC320</b>	<b>UC320L3</b>	9	42	66	20	M18×1.5	11.2
105	225	112	56	3	184	153	13.2	<b>UC321</b>	—	9	44	68	20	M18×1.5	12.7
110	240	117	60	3	205	180	13.2	<b>UC322</b>	<b>UC322L3</b>	10	46	71	20	M18×1.5	15.1
120	260	126	64	3	207	185	13.5	<b>UC324</b>	<b>UC324L3</b>	11	51	75	20	M18×1.5	19.0
130	280	135	68	4	229	214	13.6	<b>UC326</b>	<b>UC326L3</b>	12	54	81	20	M20×1.5	23.6
140	300	145	72	4	253	246	13.6	<b>UC328</b>	<b>UC328L3</b>	13	59	86	20	M20×1.5	29.4

# Ball bearings for units tapered bore type (with adapter)

$d_1$  20 ~ 55 mm

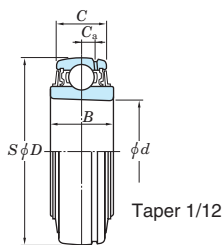

UK

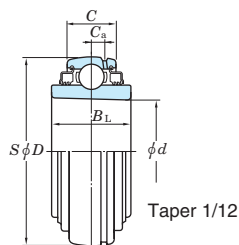

UK...L3  
(with triple-lip seals)

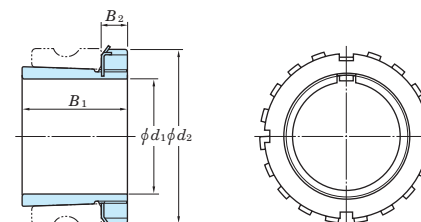

Adapter assembly

Shaft dia. (mm)	Boundary dimensions (mm)						Basic load ratings (kN)		Factor $f_0$	Bearing No.		(Refer.) Mass (kg)		Applicable adapter assembly (H3 series <sup>1)</sup> )				Applicable adapter assembly (H23 series <sup>1)</sup> )							
	$d$	$D$	$B$	$B_L$	$C$	$C_a$	$C_r$	$C_{0r}$		With standard seals	With triple-lip seals	With standard seals	With triple-lip seals	No.	Dimensions (mm)			Mass (kg)	Sleeve No.	No.	Dimensions (mm)			Mass (kg)	Sleeve No.
20	25	52	21	24	17	5	14.0	7.85	13.9	<b>UK205</b>	<b>UK205L2</b>	0.16	0.18	H305X	29	8	38	0.085	A305X	H2305X	35	8	38	0.097	A2305X
	25	62	23	—	19	5	19.5	11.3	13.9	<b>UKX05</b>	—	0.27	—	—	—	—	—	—	H2305X	35	8	38	0.097	A2305X	
	25	62	27	—	22	6	21.2	10.9	12.6	<b>UK305</b>	—	0.40	—	—	—	—	—	—	H2305X	35	8	38	0.097	A2305X	
25	30	62	23	27	19	5	19.5	11.3	13.9	<b>UK206</b>	<b>UK206L3</b>	0.25	0.29	H306X	31	8	45	0.11	A306X	H2306X	38	8	45	0.13	A2306X
	30	72	26	—	20	5.5	25.7	15.4	13.9	<b>UKX06</b>	—	0.43	—	—	—	—	—	—	H2306X	38	8	45	0.13	A2306X	
	30	72	30	—	24	6.5	26.7	15.0	13.3	<b>UK306</b>	—	0.47	—	—	—	—	—	—	H2306X	38	8	45	0.13	A2306X	
30	35	72	26	30	20	5.5	25.7	15.4	13.9	<b>UK207</b>	<b>UK207L3</b>	0.37	0.43	H307X	35	9	52	0.16	A307X	H2307X	43	9	52	0.19	A2307X
	35	80	27	—	21	6	29.1	17.8	14.0	<b>UKX07</b>	—	0.53	—	—	—	—	—	—	H2307X	43	9	52	0.19	A2307X	
	35	80	33	33	26	7.5	33.4	19.3	13.2	<b>UK307</b>	<b>UK307L3</b>	0.60	—	—	—	—	—	—	H2307X	43	9	52	0.19	A2307X	
35	40	80	27	34	21	6	29.1	17.8	14.0	<b>UK208</b>	<b>UK208L3</b>	0.47	0.58	H308X	36	10	58	0.20	A308X	H2308X	46	10	58	0.24	A2308X
	40	85	29	—	22	6	32.7	20.3	14.0	<b>UKX08</b>	—	0.58	—	—	—	—	—	—	H2308X	46	10	58	0.24	A2308X	
	40	90	35	35	28	8	40.7	24.0	13.2	<b>UK308</b>	<b>UK308L3</b>	0.80	—	—	—	—	—	—	H2308X	46	10	58	0.24	A2308X	
40	45	85	29	36	22	6	32.7	20.3	14.0	<b>UK209</b>	<b>UK209L3</b>	0.52	0.65	H309X	39	11	65	0.27	A309X	H2309X	50	11	65	0.31	A2309X
	45	90	29	—	24	6	35.1	23.3	14.4	<b>UKX09</b>	—	0.67	—	—	—	—	—	—	H2309X	50	11	65	0.31	A2309X	
	45	100	38	38	30	8.5	48.9	29.5	13.3	<b>UK309</b>	<b>UK309L3</b>	1.08	—	—	—	—	—	—	H2309X	50	11	65	0.31	A2309X	
45	50	90	29	36	24	6	35.1	23.3	14.4	<b>UK210</b>	<b>UK210L3</b>	0.59	0.65	H310X	42	12	70	0.32	A310X	H2310X	55	12	70	0.39	A2310X
	50	100	31	—	25	7	43.4	29.4	14.4	<b>UKX10</b>	—	0.89	—	—	—	—	—	—	H2310X	55	12	70	0.39	A2310X	
	50	110	40	40	32	9	62.0	38.3	13.2	<b>UK310</b>	<b>UK310L3</b>	1.38	—	—	—	—	—	—	H2310X	55	12	70	0.39	A2310X	
50	55	100	31	40	25	7	43.4	29.4	14.4	<b>UK211</b>	<b>UK211L3</b>	0.80	1.09	H311X	45	12	75	0.37	A311X	H2311X	59	12	75	0.45	A2311X
	55	110	33	—	27	7.5	52.4	36.2	14.4	<b>UKX11</b>	—	1.15	—	—	—	—	—	—	H2311X	59	12	75	0.45	A2311X	
	55	120	43	43	34	10	71.6	45.0	13.2	<b>UK311</b>	<b>UK311L3</b>	1.78	—	—	—	—	—	—	H2311X	59	12	75	0.45	A2311X	
55	60	110	33	47	27	7.5	52.4	36.2	14.4	<b>UK212</b>	<b>UK212L3</b>	1.02	1.41	H312X	47	13	80	0.42	A312X	H2312X	62	13	80	0.51	A2312X
	60	120	36	—	28	7.5	57.2	40.1	14.4	<b>UKX12</b>	—	1.45	—	—	—	—	—	—	H2312X	62	13	80	0.51	A2312X	
	60	130	47	47	36	11.5	81.9	52.2	13.2	<b>UK312</b>	<b>UK312L3</b>	2.06	—	—	—	—	—	—	H2312X	62	13	80	0.51	A2312X	

[Remarks] 1) For bearings with adapters, bearing numbers shown in dimension tables are suffixed by applicable adapter assembly numbers.  
(UK206+H306X, UK206L3+H2306X)  
2) Adapter assemblies applicable to UK 2 series are classified as follows.  
UK2..... H3 series  
UK2...L3 ..... H23 series

3) UK205 is with double-lip seals.  
4) Please consult with JTEKT when using adapter with inch series bore diameter.

**Ball bearings for units tapered bore type (with adapter)**

$d_1$  60 ~ 125 mm

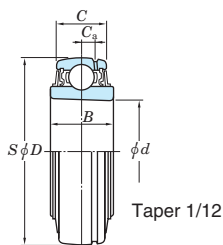

UK

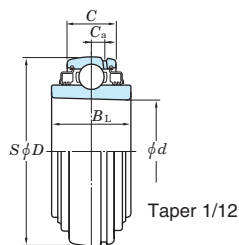

UK...L3  
(with triple-lip seals)

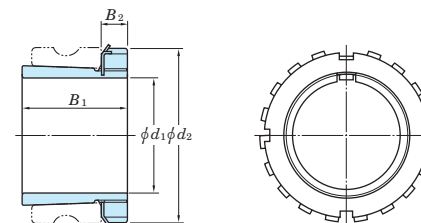

Adapter assembly

Shaft dia. (mm)	Boundary dimensions (mm)						Basic load ratings (kN)		Factor $f_0$	Bearing No.		(Refer.) Mass (kg)		Applicable adapter assembly (H3 series <sup>1)</sup> )				Applicable adapter assembly (H23 series <sup>1)</sup> )							
	$d$	$D$	$B$	$B_L$	$C$	$C_a$	$C_r$	$C_{0r}$		With standard seals	With triple-lip seals	With standard seals	With triple-lip seals	No.	Dimensions (mm)			Mass (kg)	Sleeve No.	No.	Dimensions (mm)			Mass (kg)	Sleeve No.
60	65	120	36	47	28	7.5	57.2	40.1	14.4	<b>UK213</b>	<b>UK213L3</b>	1.34	1.67	H313X	50	14	85	0.49	A313X	H2313X	65	14	85	0.59	A2313X
	65	125	40	—	30	9	62.2	44.1	14.5	<b>UKX13</b>	—	1.62	—	—	—	—	—	—	—	H2313X	65	14	85	0.59	A2313X
	65	140	49	49	38	12	92.7	59.9	13.2	<b>UK313</b>	<b>UK313L3</b>	2.71	—	—	—	—	—	—	—	H2313X	65	14	85	0.59	A2313X
65	75	130	40	51	32	9	67.4	48.3	14.5	<b>UK215</b>	<b>UK215L3</b>	1.50	1.99	H315X	55	15	98	0.89	A315X	H2315X	73	15	98	1.11	A2315X
	75	140	42	—	33	9	72.7	53.0	14.6	<b>UKX15</b>	—	2.10	—	—	—	—	—	—	—	H2315X	73	15	98	1.11	A2315X
	75	160	55	55	42	14.5	113	77.2	13.2	<b>UK315</b>	<b>UK315L3</b>	3.80	—	—	—	—	—	—	—	H2315X	73	15	98	1.11	A2315X
70	80	140	42	55	33	9	72.7	53.0	14.6	<b>UK216</b>	<b>UK216L3</b>	1.96	2.56	H316X	59	17	105	1.09	A316X	H2316X	78	17	105	1.34	A2316X
	80	150	44	—	35	10	84.0	61.9	14.5	<b>UKX16</b>	—	2.64	—	—	—	—	—	—	—	H2316X	78	17	105	1.34	A2316X
	80	170	55	55	44	15	123	86.7	13.3	<b>UK316</b>	<b>UK316L3</b>	4.39	—	—	—	—	—	—	—	H2316X	78	17	105	1.34	A2316X
75	85	150	44	57	35	10	84.0	61.9	14.5	<b>UK217</b>	<b>UK217L3</b>	2.42	3.10	H317X	63	18	110	1.24	A317X	H2317X	82	18	110	1.52	A2317X
	85	160	48	—	38	11	96.1	71.5	14.5	<b>UKX17</b>	—	3.25	—	—	—	—	—	—	—	H2317X	82	18	110	1.52	A2317X
	85	180	60	60	46	15	133	96.8	13.3	<b>UK317</b>	<b>UK317L3</b>	5.30	—	—	—	—	—	—	—	H2317X	82	18	110	1.52	A2317X
80	90	160	48	63	38	11	96.1	71.5	14.5	<b>UK218</b>	<b>UK218L3</b>	2.90	3.77	H318X	65	18	120	1.45	A318X	H2318X	86	18	120	1.70	A2318X
	90	170	50	—	40	11.5	109	81.9	14.4	<b>UKX18</b>	—	3.80	—	—	—	—	—	—	—	H2318X	86	18	120	1.70	A2318X
	90	190	60	60	48	15.5	143	107	13.3	<b>UK318</b>	<b>UK318L3</b>	6.20	—	—	—	—	—	—	—	H2318X	86	18	120	1.70	A2318X
85	95	200	66	66	50	16.5	153	119	13.3	<b>UK319</b>	<b>UK319L3</b>	7.31	—	—	—	—	—	—	—	H2319X	90	19	125	1.99	A2319X
90	100	190	54	—	43	13	133	105	14.4	<b>UKX20</b>	—	5.36	—	—	—	—	—	—	—	H2320X	97	20	130	2.28	A2320X
	100	215	68	68	54	18	173	141	13.2	<b>UK320</b>	<b>UK320L3</b>	8.70	—	—	—	—	—	—	—	H2320X	97	20	130	2.28	A2320X
100	110	240	78	78	60	20	205	180	13.2	<b>UK322</b>	<b>UK322L3</b>	12.2	—	—	—	—	—	—	—	H2322X	105	21	145	2.87	A2322X
110	120	260	87	87	64	21	207	185	13.5	<b>UK324</b>	<b>UK324L3</b>	16.1	—	—	—	—	—	—	—	H2324X	112	22	155	3.32	A2324X
115	130	280	87	87	68	22	229	214	13.6	<b>UK326</b>	<b>UK326L3</b>	18.8	—	—	—	—	—	—	—	H2326	121	23	165	4.82	A2326
125	140	300	97	97	72	23	253	246	13.6	<b>UK328</b>	<b>UK328L3</b>	23.9	—	—	—	—	—	—	—	H2328	131	24	180	5.86	A2328

[Remarks] 1) For bearings with adapters, bearing numbers shown in dimension tables are suffixed by applicable adapter assembly numbers.  
(UK206+H306X, UK206L3+H2306X)  
2) Adapter assemblies applicable to UK 2 series are classified as follows.  
UK2..... H3 series  
UK2...L3 ..... H23 series

3) Please consult with JTEKT when using adapter with inch series bore diameter.



**Ball bearings for units**  
**cylindrical bore type (with eccentric locking collar)**

*d* 20 ~ 60 mm

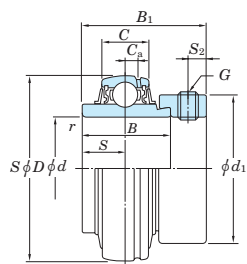

NA

Shaft dia. (mm) <i>d</i>	Boundary dimensions (mm)					Basic load ratings (kN)		Factor <i>f</i> <sub>0</sub>	Bearing No.	Dimensions (mm)				Set screw size <i>G</i>	(Refer.) Mass (kg)
	<i>D</i>	<i>B</i>	<i>B</i> <sub>1</sub>	<i>C</i>	<i>r</i> min.	<i>C</i> <sub>r</sub>	<i>C</i> <sub>0r</sub>			<i>C</i> <sub>a</sub>	<i>S</i>	<i>S</i> <sub>2</sub>	<i>d</i> <sub>1</sub>		
20	47	34.2	43.7	16	1	12.8	6.65	13.2	NA204	4	17.1	4.8	33.3	M6×0.75	0.22
25	52	34.9	44.4	17	1	14.0	7.85	13.9	NA205	5	17.5	4.8	38.1	M6×0.75	0.25
30	62	36.5	48.4	19	1	19.5	11.3	13.9	NA206	5	18.3	6	44.5	M8×1	0.41
35	72	37.6	51.1	20	1.1	25.7	15.4	13.9	NA207	5.5	18.8	6.8	55.6	M8×1	0.61
40	80	42.8	56.3	21	1.1	29.1	17.8	14.0	NA208	6	21.4	6.8	60.3	M8×1	0.78
45	85	42.8	56.3	22	1.1	32.7	20.3	14.0	NA209	6	21.4	6.8	63.5	M8×1	0.85
50	90	49.2	62.7	24	1.1	35.1	23.3	14.4	NA210	6	24.6	6.8	69.9	M8×1	1.01
55	100	55.5	71.4	25	1.5	43.4	29.4	14.4	NA211	7	27.8	8	76.2	M10×1.25	1.39
60	110	61.9	77.8	27	1.5	52.4	36.2	14.4	NA212	7.5	31	8	84.2	M10×1.25	1.87

## Plummer blocks

Plummer blocks consist of self-aligning ball bearings or spherical roller bearings, and a housing in which the bearings are installed. The housing varies in shape. Having a large load capacity and being easy to handle, plummer blocks are employed in a variety of industrial machines, such as carrying machines.



### Split type : standard

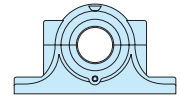

Bore diameter 30 – 170 mm

### Split type : flat bottom

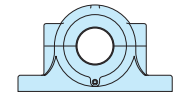

Bore diameter 20 – 140 mm

### Split type : flat bottom

(different bore diameter type/  
large bore diameter type)

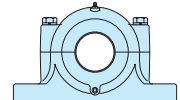

Bore diameter 25 – 160 mm

### Split type : large size

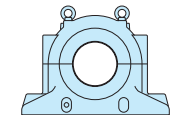

Bore diameter 150 – 360 mm

### One-piece type

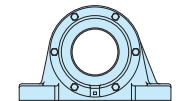

Bore diameter 20 – 170 mm

**Table 1 Plummer block types**

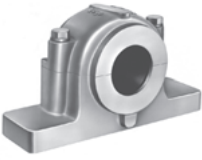
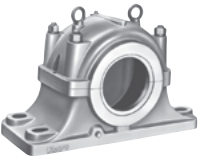
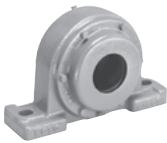
Housing type	Applicable bearing series (plummer block unit series number)	
	Self-aligning ball bearing	Spherical roller bearing
Split type : standard (SN) 	SN5 SN6 SN33 SN34	12K(SN15), 22K(SN25) 13K(SN16), 23K(SN26) — — 222K(SN225), 232K(SN235) 213K(SN216), 223K(SN226) 230K(SN233) 231K(SN234)
Small-or medium-size ; most general		
Split type : flat bottom (SSN) 	SSN5 SSN6 * SSN2 * SSN3 ** SSN2B ** SSN3B	12K(SSN15), 22K(SSN25) 13K(SSN16), 23K(SSN26) 12 (SSN12), 22 (SSN22) 13 (SSN13), 23 (SSN23) 12 (SSN12B), 22 (SSN22B) 13 (SSN13B), 23 (SSN23B) 222K(SSN225), 232K(SSN235) 213K(SSN216), 223K(SSN226) 222 (SSN222), 232 (SSN232) 213 (SSN213), 223 (SSN223) 222 (SSN222B), 232 (SSN232B) 213 (SSN213B), 223 (SSN223B)
<ul style="list-style-type: none"> <li>• Has a flat bottom and is more heavy-duty than the SN type.</li> <li>• Optionally, bolt holes can be provided.</li> </ul>		
Split type : large size (SD) 	SD5 SD6 SD31L SD33 SD34	— — — — — 222K(SD225) 223K(SD226) 231K(SD231L) 230K(SD233) 231K(SD234)
Large size and most suitable for applications which involve heavy loading.		
One-piece type (V) 	V5 V6 * V2 * V3	12K(V15), 22K(V25) 13K(V16), 23K(V26) 12 (V12), 22 (V22) 13 (V13), 23 (V23) 222K(V225), 232K(V235) 213K(V216), 223K(V226) 222 (V222), 232 (V232) 213 (V213), 223 (V223)
<ul style="list-style-type: none"> <li>• Has a monolithic housing.</li> <li>• Excellent processing performance and high rigidity.</li> </ul>		

[Notes] \* "Different bore diameter type," whose bore diameter of housing or cover differs from side to side. A cylindrical bore bearing is attached to a stepped shaft with a locknut and lockwasher.  
 \*\* "Large bore diameter type," whose housing or cover has a large-diameter bore. A cylindrical bore bearing is attached to the small side of a stepped shaft with a concentric collar.

[Remark] This catalog includes major types of plummer blocks which are boxed in the table above. For other series and special series, refer to separate catalogs.

**Table 2 Split plummer block housing dimensional tolerance (JIS B 1551)**

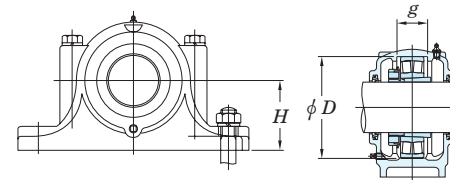

Housing series	Bearing seating bore diameter $D$	Bearing seating width $g$	Center height $H$
SN5, SN6 SN33, SN34 SSN5, SSN6 SSN2, SSN3 SD5, SD6 SD33, SD34 SD31L	H8	H13	h13

**Table 3 One-piece plummer block housing dimensional tolerance (BAS 188)**

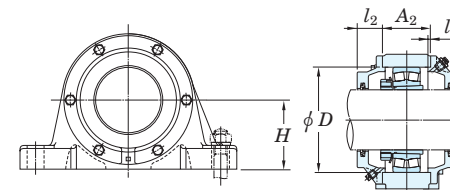

Housing series	Bearing seating bore diameter $D$	Bearing seating width $A_2$	Center height $H$	Cover size $l_2$	Cover spigot joint height $l_3$
V5, V6 V2, V3	H7	+0.2 0	h11	±1	0 -0.2

[Remark] The degree of parallelism between the bottom surface and bearing seating center line should be 1/2 000 or less.

**Table 4 Stabilizing ring dimensional tolerance**

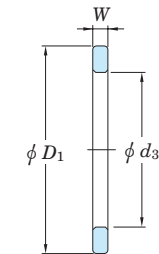

Unit : mm

Outside diameter $D_1$	Bore diameter $d_3$	Width $W$
h12	(SR47 × 5 to SR130 × 12.5) ± 0.8	0
	(SR140 × 8.5 to SR340 × 10) ± 1.2	-0.2

[Remark] Stabilizing ring is installed in bearing seating of plummer block, on the fixed side. It prevents bearing from moving in the axial direction.

Refer to Table 7-3 on pp. A 54 to A 57 for the dimensional tolerance of self-aligning ball bearings and spherical roller bearings which are used with plummer blocks. Refer to Table 7-11 on p. A 70 for tapered bore tolerances.

**Plummer blocks**  
**split type, standard**  
**SN 5, 6, 33, 34**

$d_1$  30 ~ (70) mm

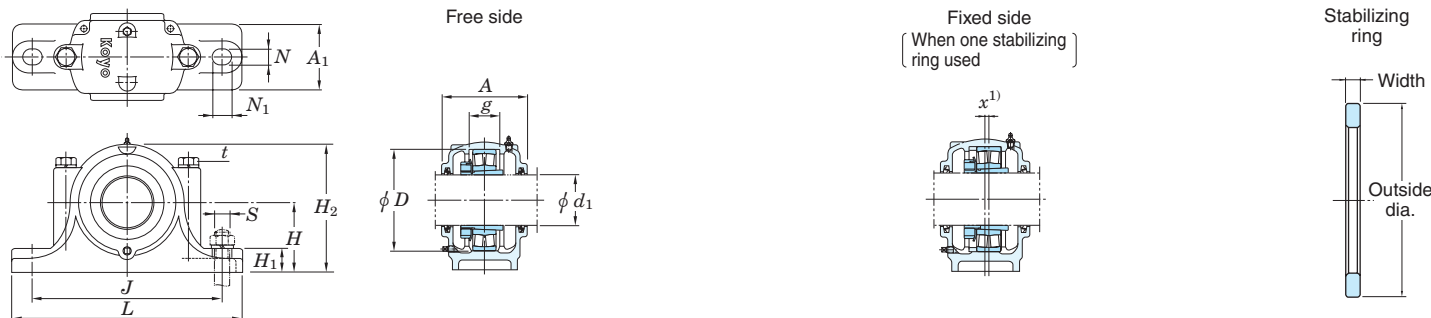

Shaft dia. (mm) $d_1$	Dimensions (mm)										Bolt size $S$	Housing No.	(Refer.) Housing mass (kg)	Grease nipple size	Drain plug size	Applicable bearing No.		Applicable adapter ass'y No.	Applicable stabilizing ring		Applicable oil seal No. MZ		
	$D$	$H$	$J$	$L$	$A$	$A_1$	$H_1$	$H_2$	$N$	$N_1$						$g$	$t$ Bolt size		Self-aligning ball brg.	Spherical roller brg.		No. Outside dia.×Width	Qty.
30	72	50	150	185	82	52	22	95	15	20	33	M10	M12	SN507	2.3	R 1/8	R 1/8	1207K 2207K	— 22207RHRK	H207X H307X	SR72×8 SR72×10	2 1	MZ07
	80	60	170	205	90	60	25	110	15	20	41	M10	M12	SN607	2.6	R 1/8	R 1/8	1307K 2307K	—	H307X H2307X	SR80×10 SR80×10	2 1	MZ07
35	80	60	170	205	85	60	25	110	15	20	33	M10	M12	SN508	2.4	R 1/8	R 1/8	1208K 2208K	— 22208RHRK	H208X H308X	SR80×7.5 SR80×10	2 1	MZ08
	90	60	170	205	95	60	25	115	15	20	43	M10	M12	SN608	2.8	R 1/8	R 1/8	1308K 2308K	21308RHK 22308RHRK	H308X H2308X	SR90×10 SR90×10	2 1	MZ08
40	85	60	170	205	85	60	25	112	15	20	31	M10	M12	SN509	2.7	R 1/8	R 1/8	1209K 2209K	— 22209RHRK	H209X H309X	SR85×6 SR85×8	2 1	MZ09
	100	70	210	255	105	70	28	130	18	23	46	M12	M16	SN609	4.3	R 1/8	R 1/8	1309K 2309K	21309RHK 22309RHRK	H309X H2309X	SR100×10.5 SR100×10	2 1	MZ09
45	90	60	170	205	90	60	25	115	15	20	33	M10	M12	SN510	3.5	R 1/8	R 1/8	1210K 2210K	— 22210RHRK	H210X H310X	SR90×6.5 SR90×10	2 1	MZ10
	110	70	210	255	115	70	30	135	18	23	50	M12	M16	SN610	4.7	R 1/8	R 1/8	1310K 2310K	21310RHK 22310RHRK	H310X H2310X	SR110×11.5 SR110×10	2 1	MZ10
50	100	70	210	255	95	70	28	130	18	23	33	M12	M16	SN511	3.7	R 1/8	R 1/8	1211K 2211K	— 22211RHRK	H211X H311X	SR100×6 SR100×8	2 1	MZ11
	120	80	230	275	120	80	30	150	18	23	53	M12	M16	SN611	5.8	R 1/8	R 1/8	1311K 2311K	21311RHK 22311RHRK	H311X H2311X	SR120×12 SR120×10	2 1	MZ11
55	110	70	210	255	105	70	30	135	18	23	38	M12	M16	SN512	4.4	R 1/8	R 1/8	1212K 2212K	— 22212RHRK	H212X H312X	SR110×8 SR110×10	2 1	MZ12
	130	80	230	280	125	80	30	155	18	23	56	M12	M16	SN612	6.4	R 1/8	R 1/8	1312K 2312K	21312RHK 22312RHRK	H312X H2312X	SR130×12.5 SR130×10	2 1	MZ12
60	120	80	230	275	110	80	30	150	18	23	43	M12	M16	SN513	5.4	R 1/8	R 1/8	1213K 2213K	— 22213RHRK	H213X H313X	SR120×10 SR120×12	2 1	MZ13
	140	95	260	315	130	90	32	175	22	27	58	M16	M20	SN613	8.6	R 1/8	R 1/8	1313K 2313K	21313RHK 22313RHRK	H313X H2313X	SR140×12.5 SR140×10	2 1	MZ13
65	130	80	230	280	115	80	30	155	18	23	41	M12	M16	SN515	6.1	R 1/8	R 1/8	1215K 2215K	— 22215RHRK	H215X H315X	SR130×8 SR130×10	2 1	MZ15
	160	100	290	345	140	100	35	195	22	27	65	M16	M20	SN615	11.8	R 1/8	R 1/8	1315K 2315K	21315RHK 22315RHRK	H315X H2315X	SR160×14 SR160×10	2 1	MZ15
70	140	95	260	315	120	90	32	175	22	27	43	M16	M20	SN516	8.2	R 1/8	R 1/8	1216K 2216K	— 22216RHRK	H216X H316X	SR140×8.5 SR140×10	2 1	MZ16

[Note] 1) Dimension  $x$  shows the shear between center of bearing and housing when one stabilizing ring is used. The value is 1/2 the width dimension of stabilizing ring. When mounting two stabilizing rings,  $x$  becomes equal to 0, since they are mounted to each side of bearing.

[Remark] Housings shown below are equipped with eyebolts.  
 SN524~SN532, SN620~SN632, SN3328~SN3338, SN3426~SN3438

**Plummer blocks**  
**split type, standard**  
**SN 5, 6, 33, 34**

$d_1$  (70) ~ (115) mm

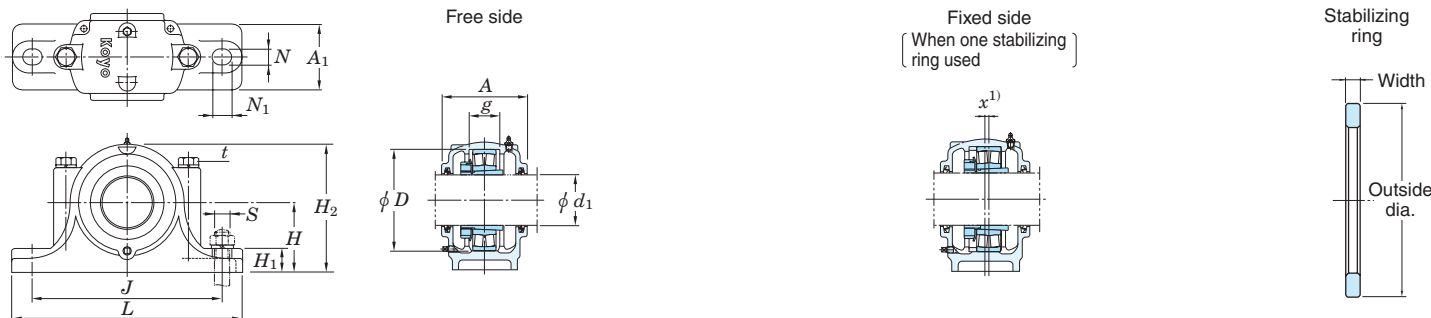

Shaft dia. (mm) $d_1$	Dimensions (mm)											Bolt size $S$	Housing No.	(Refer.) Housing mass (kg)	Grease nipple size	Drain plug size	Applicable bearing No.		Applicable adapter ass'y No.	Applicable stabilizing ring		Applicable oil seal No. MZ
	$D$	$H$	$J$	$L$	$A$	$A_1$	$H_1$	$H_2$	$N$	$N_1$	$g$						$t$ Bolt size	Self-aligning ball brg.		Spherical roller brg.	No. Outside dia.×Width	
70	170	112	290	345	145	100	35	212	22	27	68	M16	M20	13.6	R 1/8	R 1/8	1316K 2316K	21316RHK 22316RHRK	H316X H2316X	SR170×14.5 SR170×10	2 1	MZ16
	150	95	260	320	125	90	32	185	22	27	46	M16	M20	9.3	R 1/8	R 1/8	1217K 2217K	— 22217RHRK	H217X H317X	SR150×9 SR150×10	2 1	MZ17
75	180	112	320	380	155	110	40	223	26	32	70	M20	M24	16.8	R 1/8	R 1/8	1317K 2317K	21317RHK 22317RHRK	H317X H2317X	SR180×14.5 SR180×10	2 1	MZ17
	160	100	290	345	145	100	35	195	22	27	62.4	M16	M20	12	R 1/8	R 1/8	1218K 2218K	— 22218RHRK	H218X H318X	SR160×16.2 SR160×11.2	2 2	MZ18
80	190	112	320	380	160	110	40	230	26	32	74	M20	M24	21	R 1/4	R 1/4	1318K 2318K	— 22318RHRK	H318X H2318X	SR190×15.5 SR190×10	2 1	MZ18
	170	112	290	345	140	100	35	210	22	27	53	M16	M20	13	R 1/8	R 1/8	1219K 2219K	— 22219RHRK	H219X H319X	SR170×10.5 SR170×10	2 1	MZ19
85	200	125	350	410	170	120	45	250	26	32	77	M20	M24	23	R 1/4	R 1/4	1319K 2319K	— 22319RHRK	H319X H2319X	SR200×16 SR200×10	2 1	MZ19
	180	112	320	380	160	110	40	223	26	32	70.3	M20	M24	17	R 1/4	R 1/4	1220K 2220K	— 22220RHRK	H220X H320X	SR180×18.1 SR180×12.1	2 2	MZ20
90	215	140	350	410	175	120	45	270	26	32	83	M20	M24	31	R 1/4	R 1/4	1320K 2320K	— 22320RHRK	H320X H2320X	SR215×18 SR215×10	2 1	MZ20
	180	112	320	380	155	110	40	223	26	32	66	M20	M24	20	R 1/4	R 1/4	—	23122RHK	H3122X	SR180×10	1	MZ22
	200	125	350	410	175	120	45	245	26	32	80	M20	M24	20	R 1/4	R 1/4	1222K 2222K	— 22222RHRK	H222X H322X	SR200×21 SR200×13.5	2 2	MZ22
100	240	150	390	450	190	130	50	300	28	36	90	M24	M24	38	R 1/4	R 1/4	1322K 2322K	— 22322RHRK	H322X H2322X	SR240×20 SR240×10	2 1	MZ22
	180	112	320	380	150	110	40	223	26	32	56	M20	M24	19	R 1/4	R 1/4	—	23024RHK	H3024	SR180×10	1	MZ24
	200	125	350	410	165	120	45	245	26	32	72	M20	M24	22	R 1/4	R 1/4	—	23124RHK	H3124	SR200×10	1	MZ24
110	215	140	350	410	185	120	45	270	26	32	86	M20	M24	23	R 1/4	R 1/4	—	22224RHRK 23224RHK	H3124 H2324	SR215×14 SR215×10	2 1	MZ24
	260	160	450	530	200	160	60	320	33	42	96	M24	M30	48	R 1/4	R 1/4	—	22324RHRK	H2324	SR260×10	1	MZ24
115	200	125	350	410	160	120	45	245	26	32	62	M20	M24	21	R 1/4	R 1/4	—	23026RHK	H3026	SR200×10	1	MZ26

[Note] 1) Dimension  $x$  shows the shear between center of bearing and housing when one stabilizing ring is used. The value is 1/2 the width dimension of stabilizing ring.  
 When mounting two stabilizing rings,  $x$  becomes equal to 0, since they are mounted to each side of bearing.

[Remark] Housings shown below are equipped with eyebolts.  
 SN524~SN532, SN620~SN632, SN3328~SN3338, SN3426~SN3438

**Plummer blocks**  
**split type, standard**  
**SN 5, 6, 33, 34**

$d_1$  (115) ~ 150 mm

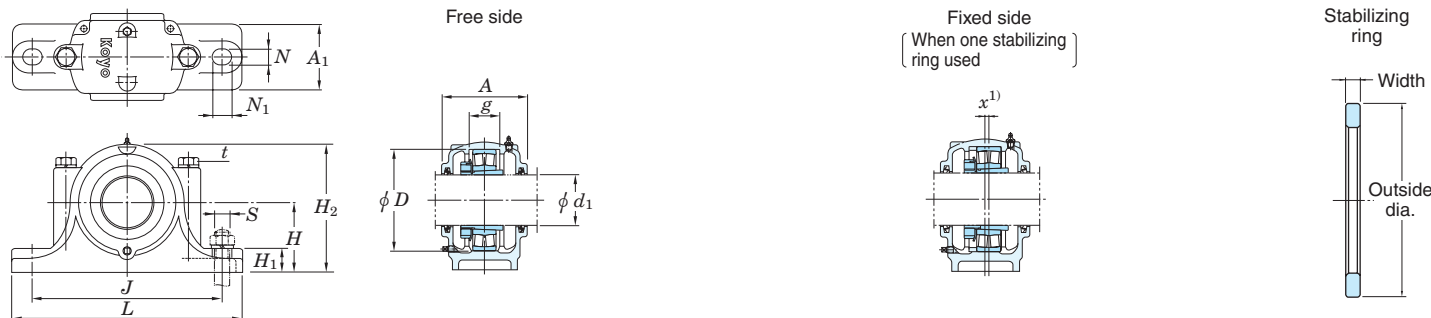

Shaft dia. (mm) $d_1$	Dimensions (mm)											Bolt size $S$	Housing No.	(Refer.) Housing mass (kg)	Grease nipple size	Drain plug size	Applicable bearing No.		Applicable adapter ass'y No.	Applicable stabilizing ring		Applicable oil seal No. MZ
	$D$	$H$	$J$	$L$	$A$	$A_1$	$H_1$	$H_2$	$N$	$N_1$	$g$						$t$ Bolt size	Self-aligning ball brg.		Spherical roller brg.	No. Outside dia.×Width	
115	210	140	350	410	170	120	45	270	26	32	74	M20	M24	29	R 1/4	R 1/4	— 23126RHK	H3126	SR210×10	1	MZ26	
	230	150	380	445	190	130	50	290	28	36	90	M24	M24	33	R 1/4	R 1/4	— 22226RHRK 23226RHK	H3126 H2326	SR230×13 SR230×10	2 1	MZ26	
	280	170	470	550	210	160	60	340	33	42	103	M24	M30	78	R 1/4	R 1/4	— 22326RHRK	H2326	SR280×10	1	MZ26	
125	210	140	350	410	170	120	45	270	26	32	63	M20	M24	28	R 1/4	R 1/4	— 23028RHK	H3028	SR210×10	1	MZ28	
	225	150	380	445	180	130	50	290	28	36	78	M24	M24	36	R 1/4	R 1/4	— 23128RHK	H3128	SR225×10	1	MZ28	
	250	150	420	500	205	150	50	305	33	42	98	M24	M30	40	R 1/4	R 1/4	— 22228RHRK 23228RHK	H3128 H2328	SR250×15 SR250×10	2 1	MZ28	
	300	180	520	610	235	170	65	365	35	45	112	M30	M30	97	R 1/4	R 1/4	— 22328RK	H2328	SR300×10	1	MZ28	
135	225	150	380	445	175	130	50	290	28	36	66	M24	M24	32	R 1/4	R 1/4	— 23030RHK	H3030	SR225×10	1	MZ30	
	250	150	420	500	200	150	50	305	33	42	90	M24	M30	42	R 1/4	R 1/4	— 23130RHK	H3130	SR250×10	1	MZ30	
	270	160	450	530	220	160	60	325	33	42	106	M24	M30	45	R 1/4	R 1/4	— 22230RHRK 23230RHK	H3130 H2330	SR270×16.5 SR270×10	2 1	MZ30	
	320	190	560	650	245	180	65	385	35	45	118	M30	M30	110	R 1/4	R 1/4	— 22330RK	H2330	SR320×10	1	MZ30	
140	240	150	390	450	190	130	50	300	28	36	70	M24	M24	36	R 1/4	R 1/4	— 23032RHK	H3032	SR240×10	1	MZ32	
	270	160	450	530	215	160	60	325	33	42	96	M24	M30	53	R 1/4	R 1/4	— 23132RHK	H3132	SR270×10	1	MZ32	
	290	170	470	550	235	160	60	345	33	42	114	M24	M30	51	R 1/4	R 1/4	— 22232RK 23232RK	H3132 H2332	SR290×17 SR290×10	2 1	MZ32	
	340	200	580	680	255	190	70	405	42	50	124	M30	M36	120	R 1/4	R 1/4	— 22332RK	H2332	SR340×10	1	MZ32	
150	260	160	450	530	200	160	60	320	33	42	77	M24	M30	45	R 1/4	R 1/4	— 23034RHK	H3034	SR260×10	1	MZ34	
	280	170	470	550	220	160	60	340	33	42	98	M24	M30	61	R 1/4	R 1/4	— 23134RHK	H3134	SR280×10	1	MZ34	

[Note] 1) Dimension  $x$  shows the shear between center of bearing and housing when one stabilizing ring is used. The value is 1/2 the width dimension of stabilizing ring. When mounting two stabilizing rings,  $x$  becomes equal to 0, since they are mounted to each side of bearing.

[Remark] Housings shown below are equipped with eyebolts. SN524~SN532, SN620~SN632, SN3328~SN3338, SN3426~SN3438

**Plummer blocks**  
**split type, standard**  
**SN 5, 6, 33, 34**  
 $d_1$  160 ~ 170 mm

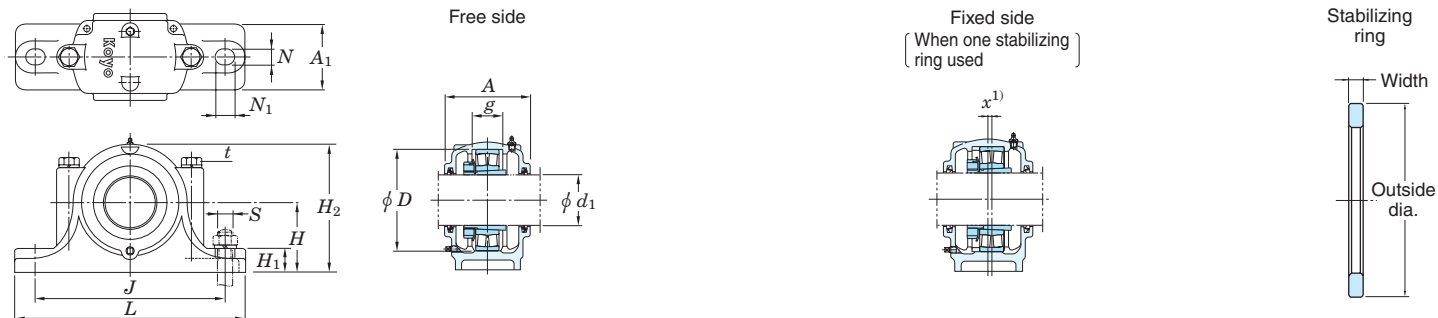

Shaft dia. (mm) $d_1$	Dimensions (mm)												Bolt size $S$	Housing No.	(Refer.) Housing mass (kg)	Grease nipple size	Drain plug size	Applicable bearing No.		Applicable adapter ass'y No.	Applicable stabilizing ring		Applicable oil seal No. MZ
	$D$	$H$	$J$	$L$	$A$	$A_1$	$H_1$	$H_2$	$N$	$N_1$	$g$	$t$ Bolt size						Self-aligning ball brg.	Spherical roller brg.		No. Outside dia.×Width	Qty.	
160	280	170	470	550	210	160	60	340	33	42	84	M24	M30	SN3336	57	R 1/4	R 1/4	—	23036RHK	H3036	SR280×10	1	MZ36
	300	180	520	610	230	170	65	365	35	45	106	M30	M30	SN3436	80	R 1/4	R 1/4	—	23136RK	H3136	SR300×10	1	MZ36
170	290	170	470	550	210	160	60	345	33	42	85	M24	M30	SN3338	59	R 1/4	R 1/4	—	23038RK	H3038	SR290×10	1	MZ38
	320	190	560	650	240	180	65	385	35	45	114	M30	M30	SN3438	95	R 1/4	R 1/4	—	23138RK	H3138	SR320×10	1	MZ38

[Note] 1) Dimension  $x$  shows the shear between center of bearing and housing when one stabilizing ring is used. The value is 1/2 the width dimension of stabilizing ring.  
 When mounting two stabilizing rings,  $x$  becomes equal to 0, since they are mounted to each side of bearing.

[Remark] Housings shown below are equipped with eyebolts.  
 SN524~SN532, SN620~SN632, SN3328~SN3338, SN3426~SN3438

**Plummer blocks**  
**split type, flat bottom**  
**SSN 5, 6**

$d_1$  20 ~ (60) mm

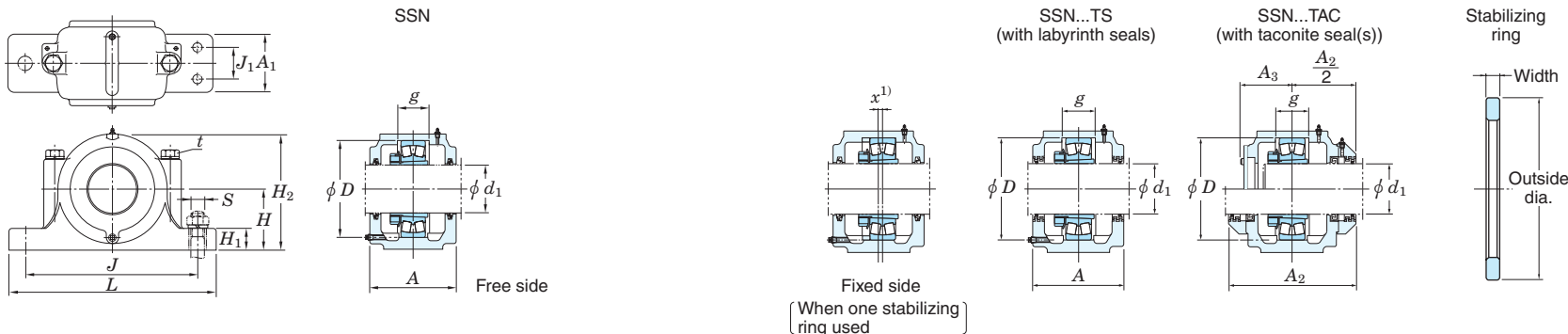

Shaft dia. (mm) $d_1$	Dimensions (mm)												Bolt size		Housing No.		(Refer.) Housing mass (kg)	Grease nipple size	Drain plug size	Applicable bearing No.		Applicable adapter ass'y No.	Applicable stabilizing ring		Applicable oil seal No. MZ
	D	H	J	J <sub>1</sub>	L	A	A <sub>1</sub>	A <sub>2</sub>	A <sub>3</sub>	H <sub>1</sub>	H <sub>2</sub>	g	t Bolt size	S (Two) (Four)						Self-aligning ball brg.	Spherical roller brg.		Outside dia.×Width	Qty.	
20	52	40	130	25	165	67	46	—	—	22	75	25	M8	M12	M10	<b>SSN505</b>	1.8	R 1/8	R 1/8	1205K 2205K	— 22205RHRK	H205X H305X	SR52×5 SR52×7	2 1	MZ05
	62	50	150	25	185	80	52	—	—	22	90	34	M8	M12	M10	<b>SSN605</b>	2.6	R 1/8	R 1/8	1305K 2305K	—	H305X H2305X	SR62×8.5 SR62×10	2 1	MZ05
25	62	50	150	25	185	77	52	—	—	22	90	30	M8	M12	M10	<b>SSN506</b>	2.7	R 1/8	R 1/8	1206K 2206K	— 22206RHRK	H206X H306X	SR62×7 SR62×10	2 1	MZ06
	72	50	150	25	185	82	52	—	—	22	95	37	M10	M12	M10	<b>SSN606</b>	2.8	R 1/8	R 1/8	1306K 2306K	—	H306X H2306X	SR72×9 SR72×10	2 1	MZ06
30	72	50	150	25	185	82	52	—	—	22	95	33	M10	M12	M10	<b>SSN507</b>	3.0	R 1/8	R 1/8	1207K 2207K	— 22207RHRK	H207X H307X	SR72×8 SR72×10	2 1	MZ07
	80	60	170	30	205	90	60	—	—	25	110	41	M10	M12	M10	<b>SSN607</b>	3.8	R 1/8	R 1/8	1307K 2307K	—	H307X H2307X	SR80×10 SR80×10	2 1	MZ07
35	80	60	170	30	205	85	60	—	—	25	110	33	M10	M12	M10	<b>SSN508</b>	3.8	R 1/8	R 1/8	1208K 2208K	— 22208RHRK	H208X H308X	SR80×7.5 SR80×10	2 1	MZ08
	90	60	170	30	205	95	60	—	—	25	115	43	M10	M12	M10	<b>SSN608</b>	3.9	R 1/8	R 1/8	1308K 2308K	21308RHK 22308RHRK	H308X H2308X	SR90×10 SR90×10	2 1	MZ08
40	85	60	170	30	205	85	60	—	—	25	112	31	M10	M12	M10	<b>SSN509</b>	4.3	R 1/8	R 1/8	1209K 2209K	— 22209RHRK	H209X H309X	SR85×6 SR85×8	2 1	MZ09
	100	70	210	35	255	105	70	—	—	28	130	46	M12	M16	M12	<b>SSN609</b>	6.2	R 1/8	R 1/8	1309K 2309K	21309RHK 22309RHRK	H309X H2309X	SR100×10.5 SR100×10	2 1	MZ09
45	90	60	170	30	205	90	60	—	—	25	115	33	M10	M12	M10	<b>SSN510</b>	5.2	R 1/8	R 1/8	1210K 2210K	— 22210RHRK	H210X H310X	SR90×6.5 SR90×10	2 1	MZ10
	110	70	210	35	255	115	70	—	—	30	135	50	M12	M16	M12	<b>SSN610</b>	6.5	R 1/8	R 1/8	1310K 2310K	21310RHK 22310RHRK	H310X H2310X	SR110×11.5 SR110×10	2 1	MZ10
50	100	70	210	35	255	95	70	160	57	28	130	33	M12	M16	M12	<b>SSN511</b>	5.5	R 1/8	R 1/8	1211K 2211K	— 22211RHRK	H211X H311X	SR100×6 SR100×8	2 1	MZ11
	120	80	230	40	275	120	80	185	70	30	150	53	M12	M16	M12	<b>SSN611</b>	8.5	R 1/8	R 1/8	1311K 2311K	21311RHK 22311RHRK	H311X H2311X	SR120×12 SR120×10	2 1	MZ11
55	110	70	210	35	255	105	70	164	62	30	135	38	M12	M16	M12	<b>SSN512</b>	6.3	R 1/8	R 1/8	1212K 2212K	— 22212RHRK	H212X H312X	SR110×8 SR110×10	2 1	MZ12
	130	80	230	40	280	125	80	184	72	30	155	56	M12	M16	M12	<b>SSN612</b>	8.9	R 1/8	R 1/8	1312K 2312K	21312RHK 22312RHRK	H312X H2312X	SR130×12.5 SR130×10	2 1	MZ12
60	120	80	230	40	275	110	80	168	65	30	150	43	M12	M16	M12	<b>SSN513</b>	6.8	R 1/8	R 1/8	1213K 2213K	— 22213RHRK	H213X H313X	SR120×10 SR120×12	2 1	MZ13

[Note] 1) Dimension x shows the shear between center of bearing and housing when one stabilizing ring is used. The value is 1/2 the width dimension of stabilizing ring.  
 When mounting two stabilizing rings, x becomes equal to 0, since they are mounted to each side of bearing.

[Remarks] 1) Use of labyrinth or taconite seals are indicated by TS or TAC suffixed to housing numbers.  
 2) Housings shown below are equipped with eyebolts.  
 SSN524~SSN532, SSN618~SSN632



**Plummer blocks**  
**split type, flat bottom**  
**SSN 5, 6**

$d_1$  (60) ~ 110 mm

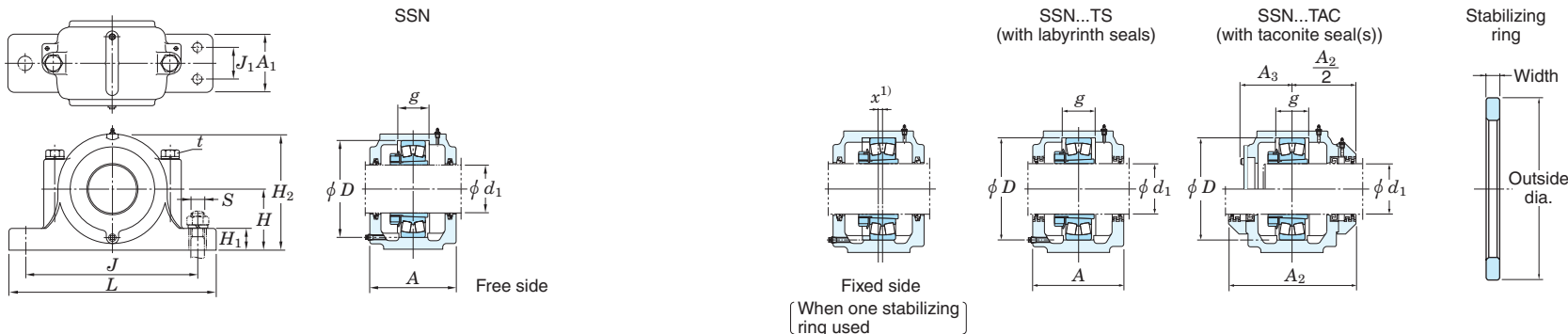

Shaft dia. (mm) $d_1$	Dimensions (mm)												Bolt size		Housing No.	(Refer.) Housing mass (kg)	Grease nipple size	Drain plug size	Applicable bearing No.		Applicable adapter ass'y No.	Applicable stabilizing ring		Applicable oil seal No. MZ	
	D	H	J	J <sub>1</sub>	L	A	A <sub>1</sub>	A <sub>2</sub>	A <sub>3</sub>	H <sub>1</sub>	H <sub>2</sub>	g	t Bolt size	S (Two) (Four)					Self-aligning ball brg.	Spherical roller brg.		Outside dia.×Width	Qty.		
60	140	95	260	50	315	130	90	188	75	32	175	58	M16	M20	M16	SSN613	12.9	R 1/8	R 1/8	1313K	21313RHK	H313X	SR140×12.5	2	MZ13
																								2313K	
65	130	80	230	40	280	115	80	172	67	30	155	41	M12	M16	M12	SSN515	7.9	R 1/8	R 1/8	1215K	—	H215X	SR130×8	2	MZ15
																								2215RHRK	
65	160	100	290	50	345	140	100	197	80	35	195	65	M16	M20	M16	SSN615	16.5	R 1/8	R 1/8	1315K	21315RHK	H315X	SR160×14	2	MZ15
																								2315RHRK	
70	140	95	260	50	315	120	90	190	70	32	175	43	M16	M20	M16	SSN516	12	R 1/8	R 1/8	1216K	—	H216X	SR140×8.5	2	MZ16
																								22216RHRK	
70	170	112	290	50	345	145	100	215	83	35	212	68	M16	M20	M16	SSN616	18	R 1/8	R 1/8	1316K	21316RHK	H316X	SR170×14.5	2	MZ16
																								2316RHRK	
75	150	95	260	50	320	125	90	194	75	32	185	46	M16	M20	M16	SSN517	13	R 1/8	R 1/8	1217K	—	H217X	SR150×9	2	MZ17
																								22217RHRK	
75	180	112	320	60	380	155	110	224	90	40	223	70	M20	M24	M20	SSN617	25.8	R 1/8	R 1/8	1317K	21317RHK	H317X	SR180×14.5	2	MZ17
																								2317RHRK	
80	160	100	290	50	345	145	100	214	85	35	195	62.4	M16	M20	M16	SSN518	17	R 1/8	R 1/8	1218K	—	H218X	SR160×16.2	2	MZ18
																								22218RHRK	
80	190	112	320	60	380	160	110	229	93	40	230	74	M20	M24	M20	SSN618	28	R 1/4	R 1/4	1318K	—	H318X	SR160×10	1	MZ18
																								2318RHRK	
85	170	112	290	50	345	140	100	214	85	35	210	53	M16	M20	M16	SSN519	18	R 1/8	R 1/8	1219K	—	H219X	SR170×10.5	2	MZ19
																								22219RHRK	
85	200	125	350	70	410	170	120	235	98	45	250	77	M20	M24	M20	SSN619	31	R 1/4	R 1/4	1319K	—	H319X	SR200×16	2	MZ19
																								2319RHRK	
90	180	112	320	60	380	160	110	220	92	40	223	70.3	M20	M24	M16	SSN520	24	R 1/4	R 1/4	1220K	—	H220X	SR180×18.1	2	MZ20
																								22220RHRK	
90	215	140	350	70	410	175	120	235	100	45	270	83	M20	M24	M20	SSN620	41	R 1/4	R 1/4	1320K	—	H320X	SR215×18	2	MZ20
																								2320RHRK	
100	200	125	350	70	410	175	120	240	100	45	245	80	M20	M24	M16	SSN522	28	R 1/4	R 1/4	1222K	—	H322X	SR200×21	2	MZ22
																								22222RHRK	
100	240	150	390	70	450	190	130	255	108	50	300	90	M24	M24	M24	SSN622	51	R 1/4	R 1/4	1322K	—	H322X	SR240×20	2	MZ22
																								2322RHRK	
110	215	140	350	70	410	185	120	254	110	45	270	86	M20	M24	M16	SSN524	33	R 1/4	R 1/4	—	22224RHRK	H3124	SR215×14	2	MZ24
																								23224RHK	
	260	160	450	90	530	200	160	269	118	60	320	96	M24	M30	M24	SSN624	63	R 1/4	R 1/4	—	22324RHRK	H2324	SR260×10	1	MZ24

[Note] 1) Dimension x shows the shear between center of bearing and housing when one stabilizing ring is used. The value is 1/2 the width dimension of stabilizing ring.  
 When mounting two stabilizing rings, x becomes equal to 0, since they are mounted to each side of bearing.

[Remarks] 1) Use of labyrinth or taconite seals are indicated by TS or TAC suffixed to housing numbers.  
 2) Housings shown below are equipped with eyebolts.  
 SSN524~SSN532, SSN618~SSN632

**Plummer blocks**  
**split type, flat bottom**  
**SSN 5, 6**

$d_1$  115 ~ 140 mm

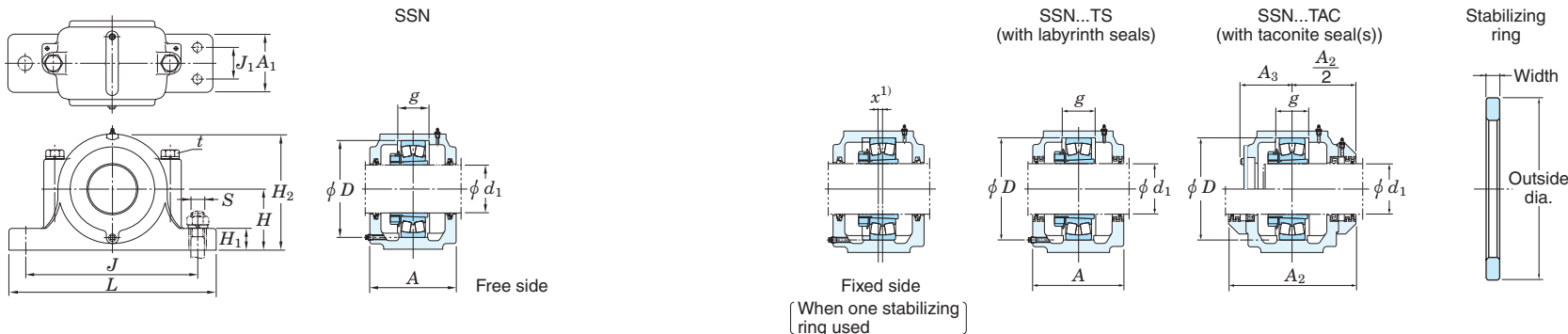

Shaft dia. (mm)	Dimensions (mm)												Bolt size		Housing No.	(Refer.) Housing mass (kg)	Grease nipple size	Drain plug size	Applicable bearing No.		Applicable adapter ass'y No.	Applicable stabilizing ring		Applicable oil seal No.	
	$d_1$	D	H	J	$J_1$	L	A	$A_1$	$A_2$	$A_3$	$H_1$	$H_2$	g	t Bolt size					S (Two) (Four)	Self-aligning ball brg.		Spherical roller brg.	Outside dia.×Width		Qty.
115	230	150	380	70	445	190	130	260	112	50	290	90	M24	M24	M20	SSN526	45	R 1/4	R 1/4	—	22226RHRK 23226RHK	H3126 H2326	SR230×13 SR230×10	2 1	MZ26
	280	170	470	90	550	210	160	280	122	60	340	103	M24	M30	M24	SSN626	96	R 1/4	R 1/4	—	22326RHRK	H2326	SR280×10	1	MZ26
125	250	150	420	80	500	205	150	274	120	50	305	98	M24	M30	M24	SSN528	54	R 1/4	R 1/4	—	22228RHRK 23228RHK	H3128 H2328	SR250×15 SR250×10	2 1	MZ28
	300	180	520	100	610	235	170	304	135	65	365	112	M30	M30	M24	SSN628	117	R 1/4	R 1/4	—	22328RK	H2328	SR300×10	1	MZ28
135	270	160	450	90	530	220	160	280	127	60	325	106	M24	M30	M24	SSN530	60	R 1/4	R 1/4	—	22230RHRK 23230RHK	H3130 H2330	SR270×16.5 SR270×10	2 1	MZ30
	320	190	560	110	650	245	180	310	140	65	385	118	M30	M30	M24	SSN630	132	R 1/4	R 1/4	—	22330RK	H2330	SR320×10	1	MZ30
140	290	170	470	90	550	235	160	300	135	60	345	114	M24	M30	M24	SSN532	69	R 1/4	R 1/4	—	22232RK 23232RK	H3132 H2332	SR290×17 SR290×10	2 1	MZ32
	340	200	580	110	680	255	190	320	145	70	405	124	M30	M36	M30	SSN632	145	R 1/4	R 1/4	—	22332RK	H2332	SR340×10	1	MZ32

[Note] 1) Dimension x shows the shear between center of bearing and housing when one stabilizing ring is used. The value is 1/2 the width dimension of stabilizing ring.  
 When mounting two stabilizing rings, x becomes equal to 0, since they are mounted to each side of bearing.

[Remarks] 1) Use of labyrinth or taconite seals are indicated by TS or TAC suffixed to housing numbers.  
 2) Housings shown below are equipped with eyebolts.  
 SSN524~SSN532, SSN618~SSN632

**Plummer blocks**  
**split type, flat bottom**  
**different bore type**  
**SSN 2, 3**  
**large bore type**  
**SSN 2B, 3B**  
 $d_1$  20 ~ (60) mm

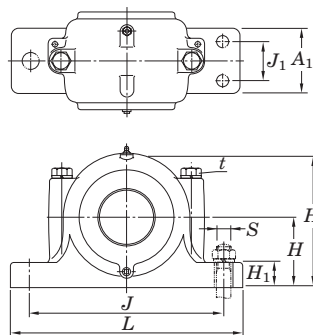

SSN 2, 3  
 Different bore type  
 (locknut locking)

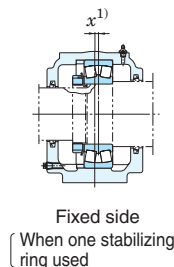
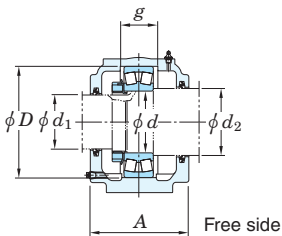

SSN 2B, 3B  
 Large bore type  
 (concentric collar locking)

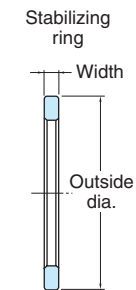
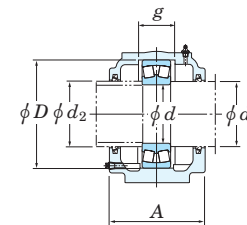

Shaft diameter (mm)	Dimensions (mm)												Bolt size		Housing No.	(Refer.) Housing mass (kg)	Grease nipple size	Drain plug size	Applicable bearing No.		Applicable stabilizing ring		Applicable oil seal No.		
	$d_1$	$d$	$d_2^{2)}$	$D$	$H$	$J$	$J_1$	$L$	$A$	$A_1$	$H_1$	$H_2$	$g$	$t$ Bolt size					$S$ (Two) (Four)	Self-aligning ball brg.	Spherical roller brg.	No. Outside dia.×Width	Qty.	$d_1$ side	$d_2$ side
20	25	*30	52	40	130	25	165	67	46	22	75	25	M8	M12	M10	SSN205	1.8	R 1/8	R 1/8	1205 2205	— 22205RHR	SR52×5 SR52×7	2 1	MZ05	MZ07
	25	30	62	50	150	25	185	80	52	22	90	34	M8	M12	M10	SSN305	2.6	R 1/8	R 1/8	1305 2305	—	SR62×8.5 SR62×10	2 1	MZ05	MZ07
25	30	*35	62	50	150	25	185	77	52	22	90	30	M8	M12	M10	SSN206	2.7	R 1/8	R 1/8	1206 2206	— 22206RHR	SR62×7 SR62×10	2 1	MZ06	MZ08
	30	35	72	50	150	25	185	82	52	22	95	37	M10	M12	M10	SSN306	2.8	R 1/8	R 1/8	1306 2306	—	SR72×9 SR72×10	2 1	MZ06	MZ08
30	35	45	72	50	150	25	185	82	52	22	95	33	M10	M12	M10	SSN207	3.0	R 1/8	R 1/8	1207 2207	— 22207RHR	SR72×8 SR72×10	2 1	MZ07	MZ10
	35	45	80	60	170	30	205	90	60	25	110	41	M10	M12	M10	SSN307	3.8	R 1/8	R 1/8	1307 2307	—	SR80×10 SR80×10	2 1	MZ07	MZ10
35	40	50	80	60	170	30	205	85	60	25	110	33	M10	M12	M10	SSN208	3.8	R 1/8	R 1/8	1208 2208	— 22208RHR	SR80×7.5 SR80×10	2 1	MZ08	MZ11
	40	50	90	60	170	30	205	95	60	25	115	43	M10	M12	M10	SSN308	3.9	R 1/8	R 1/8	1308 2308	21308RH 22308RHR	SR90×10 SR90×10	2 1	MZ08	MZ11
40	45	55	85	60	170	30	205	85	60	25	112	31	M10	M12	M10	SSN209	4.3	R 1/8	R 1/8	1209 2209	— 22209RHR	SR85×6 SR85×8	2 1	MZ09	MZ12
	45	55	100	70	210	35	255	105	70	28	130	46	M12	M16	M12	SSN309	6.2	R 1/8	R 1/8	1309 2309	21309RH 22309RHR	SR100×10.5 SR100×10	2 1	MZ09	MZ12
45	50	60	90	60	170	30	205	90	60	25	115	33	M10	M12	M10	SSN210	5.2	R 1/8	R 1/8	1210 2210	— 22210RHR	SR90×6.5 SR90×10	2 1	MZ10	MZ13
	50	60	110	70	210	35	255	115	70	30	135	50	M12	M16	M12	SSN310	6.5	R 1/8	R 1/8	1310 2310	21310RH 22310RHR	SR110×11.5 SR110×10	2 1	MZ10	MZ13
50	55	65	100	70	210	35	255	95	70	28	130	33	M12	M16	M12	SSN211	5.5	R 1/8	R 1/8	1211 2211	— 22211RHR	SR100×6 SR100×8	2 1	MZ11	MZ15
	55	65	120	80	230	40	275	120	80	30	150	53	M12	M16	M12	SSN311	8.5	R 1/8	R 1/8	1311 2311	21311RH 22311RHR	SR120×12 SR120×10	2 1	MZ11	MZ15
55	60	70	110	70	210	35	255	105	70	30	135	38	M12	M16	M12	SSN212	6.3	R 1/8	R 1/8	1212 2212	— 22212RHR	SR110×8 SR110×10	2 1	MZ12	MZ16
	60	*70	130	80	230	40	280	125	80	30	155	56	M12	M16	M12	SSN312	8.9	R 1/8	R 1/8	1312 2312	21312RH 22312RHR	SR130×12.5 SR130×10	2 1	MZ12	MZ16
60	65	75	120	80	230	40	275	110	80	30	150	43	M12	M16	M12	SSN213	6.8	R 1/8	R 1/8	1213 2213	— 22213RHR	SR120×10 SR120×12	2 1	MZ13	MZ17

[Notes] 1) Dimension x shows the shear between center of bearing and housing when one stabilizing ring is used. The value is 1/2 the width dimension of stabilizing ring.  
 When mounting two stabilizing rings, x becomes equal to 0, since they are mounted to each side of bearing.  
 2) If bearing of shaft diameter marked with \* (shoulder diameter) receives large axial load, the use of spacers is recommended.

[Remarks] 1) Large bore diameter types (concentric collar locking) are identified by B suffixed to housing numbers.  
 2) Housings shown below are equipped with eyebolts.  
 SSN224~SSN232, SSN318~SSN332

**Plummer blocks**  
**split type, flat bottom**  
**different bore type**  
**SSN 2, 3**  
**large bore type**  
**SSN 2B, 3B**  
 $d_1$  (60) ~ (105) mm

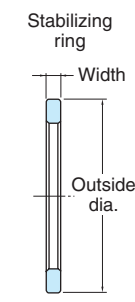
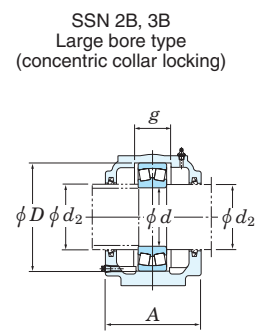
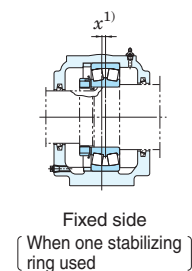
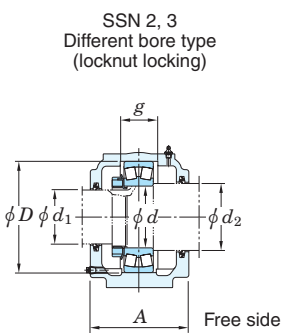
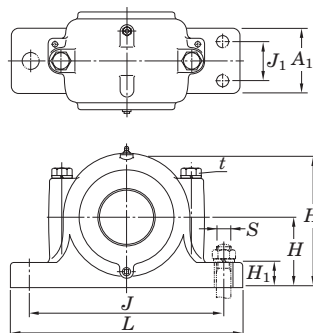

Shaft diameter (mm)			Dimensions (mm)										Bolt size		Housing No.	(Refer.) Housing mass (kg)	Grease nipple size	Drain plug size	Applicable bearing No.		Applicable stabilizing ring No.		Applicable oil seal No.	
$d_1$	$d$	$d_2^{(2)}$	$D$	$H$	$J$	$J_1$	$L$	$A$	$A_1$	$H_1$	$H_2$	$g$	$t$ Bolt size	$S$ (Two) (Four)					Self-aligning ball brg.	Spherical roller brg.	Outside dia.×Width	Qty.	$d_1$ side	$d_2$ side
60	65	*75	140	95	260	50	315	130	90	32	175	58	M16	M20 M16	SSN313	12.9	R 1/8	R 1/8	1313 2313	21313RH 22313RHR	SR140×12.5 SR140×10	2 1	MZ13	MZ17
	70	80	125	80	230	40	275	115	80	30	155	44	M12	M16 M12		SSN214	7.5	R 1/8	R 1/8	1214 2214	— 22214RHR	SR125×10 SR125×13	2 1	MZ15
65	70	*80	150	95	260	50	320	130	90	32	185	61	M16	M20 M16	SSN314	15	R 1/8	R 1/8	1314 2314	21314RH 22314RHR	SR150×13 SR150×10	2 1	MZ15	MZ18
	75	85	130	80	230	40	280	115	80	30	155	41	M12	M16 M12		SSN215	7.9	R 1/8	R 1/8	1215 2215	— 22215RHR	SR130×8 SR130×10	2 1	MZ16
70	75	*85	160	100	290	50	345	140	100	35	195	65	M16	M20 M16	SSN315	16.5	R 1/8	R 1/8	1315 2315	21315RH 22315RHR	SR160×14 SR160×10	2 1	MZ16	MZ19
	80	90	140	95	260	50	315	120	90	32	175	43	M16	M20 M16		SSN216	12	R 1/8	R 1/8	1216 2216	— 22216RHR	SR140×8.5 SR140×10	2 1	MZ17
75	80	*90	170	112	290	50	345	145	100	35	212	68	M16	M20 M16	SSN316	18	R 1/8	R 1/8	1316 2316	21316RH 22316RHR	SR170×14.5 SR170×10	2 1	MZ17	MZ20
	85	95	150	95	260	50	320	125	90	32	185	46	M16	M20 M16		SSN217	13	R 1/8	R 1/8	1217 2217	— 22217RHR	SR150×9 SR150×10	2 1	MZ18
80	85	95	180	112	320	60	380	155	110	40	223	70	M20	M24 M20	SSN317	25.8	R 1/8	R 1/8	1317 2317	21317RH 22317RHR	SR180×14.5 SR180×10	2 1	MZ18	MZ21
	90	100	160	100	290	50	345	145	100	35	195	62.4	M16	M20 M16		SSN218	17	R 1/8	R 1/8	1218 2218	— 22218RHR	SR160×16.2 SR160×11.2 SR160×10	2 2 1	MZ19
85	90	105	190	112	320	60	380	160	110	40	230	74	M20	M24 M20	SSN318	28	R 1/4	R 1/4	1318 2318	— 22318RHR	SR190×15.5 SR190×10	2 1	MZ19	MZ23
	95	110	170	112	290	50	345	140	100	35	210	53	M16	M20 M16		SSN219	18	R 1/8	R 1/8	1219 2219	— 22219RHR	SR170×10.5 SR170×10	2 1	MZ20
90	95	110	200	125	350	70	410	170	120	45	250	77	M20	M24 M20	SSN319	31	R 1/4	R 1/4	1319 2319	— 22319RHR	SR200×16 SR200×10	2 1	MZ20	MZ24
	100	115	180	112	320	60	380	160	110	40	223	70.3	M20	M24 M16		SSN220	24	R 1/4	R 1/4	1220 2220	— 22220RHR	SR180×18.1 SR180×12.1 SR180×10	2 2 1	MZ21
95	100	115	215	140	350	70	410	175	120	45	270	83	M20	M24 M20	SSN320	41	R 1/4	R 1/4	1320 2320	— 22320RHR	SR215×18 SR215×10	2 1	MZ21	MZ26
	105	110	200	125	350	70	410	175	120	45	245	80	M20	M24 M16		SSN222	28	R 1/4	R 1/4	1222 2222	— 22222RHR	SR200×21 SR200×13.5 SR200×10	2 2 1	MZ23

[Notes] 1) Dimension  $x$  shows the shear between center of bearing and housing when one stabilizing ring is used. The value is 1/2 the width dimension of stabilizing ring.  
 When mounting two stabilizing rings,  $x$  becomes equal to 0, since they are mounted to each side of bearing.  
 2) If bearing of shaft diameter marked with \* (shoulder diameter) receives large axial load, the use of spacers is recommended.

[Remarks] 1) Large bore diameter types (concentric collar locking) are identified by B suffixed to housing numbers.  
 2) Housings shown below are equipped with eyebolts.  
 SSN224~SSN232, SSN318~SSN332

**Plummer blocks**  
**split type, flat bottom**  
**different bore type**  
**SSN 2, 3**  
**large bore type**  
**SSN 2B, 3B**  
 $d_1$  (105) ~ 150 mm

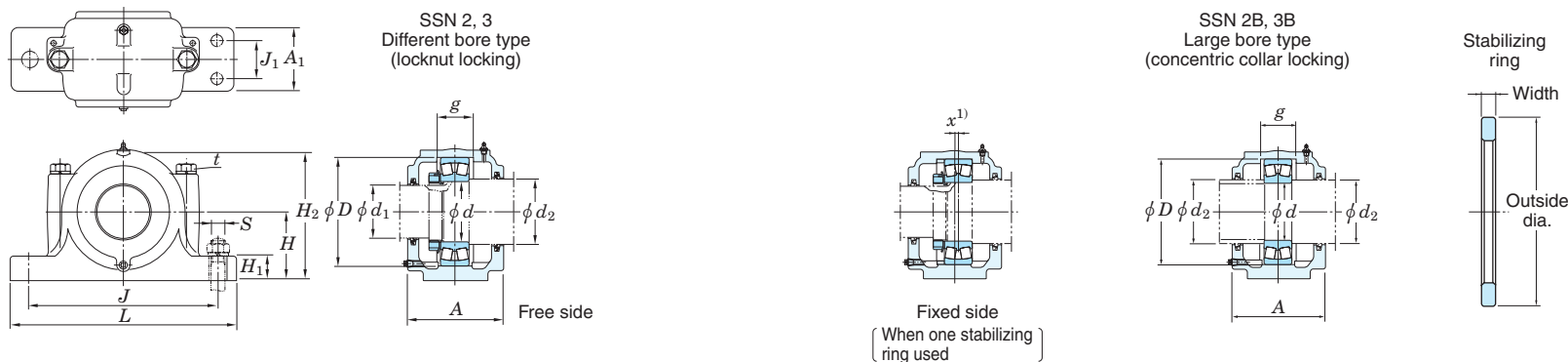

Shaft diameter (mm)			Dimensions (mm)										Bolt size		Housing No.	(Refer.) Housing mass (kg)	Grease nipple size	Drain plug size	Applicable bearing No.		Applicable stabilizing ring		Applicable oil seal No.		
$d_1$	$d$	$d_2^{2)}$	$D$	$H$	$J$	$J_1$	$L$	$A$	$A_1$	$H_1$	$H_2$	$g$	$t$ Bolt size	$S$ (Two) (Four)					Self-aligning ball brg.	Spherical roller brg.	Outside dia.×Width	Qty.	$d_1$ side	$d_2$ side	
105	110	125	240	150	390	70	450	190	130	50	300	90	M24	M24	M24	SSN322	51	R 1/4	R 1/4	1322 2322	— 22322RHR	SR240×20 SR240×10	2 1	MZ23	MZ28
	120	135	215	140	350	70	410	185	120	45	270	86	M20	M24	M16	SSN224	33	R 1/4	R 1/4	—	22224RHR 23224RH	SR215×14 SR215×10	2 1	MZ26	MZ30
115	120	135	260	160	450	90	530	200	160	60	320	96	M24	M30	M24	SSN324	63	R 1/4	R 1/4	—	22324RHR	SR260×10	1	MZ26	MZ30
	130	145	230	150	380	70	445	190	130	50	290	90	M24	M24	M20	SSN226	45	R 1/4	R 1/4	—	22226RHR 23226RH	SR230×13 SR230×10	2 1	MZ28	MZ33
125	130	150	280	170	470	90	550	210	160	60	340	103	M24	M30	M24	SSN326	96	R 1/4	R 1/4	—	22326RHR	SR280×10	1	MZ28	MZ34
	140	155	250	150	420	80	500	205	150	50	305	98	M24	M30	M24	SSN228	54	R 1/4	R 1/4	—	22228RHR 23228RH	SR250×15 SR250×10	2 1	MZ30	MZ35
135	140	160	300	180	520	100	610	235	170	65	365	112	M30	M30	M24	SSN328	117	R 1/4	R 1/4	—	22328R	SR300×10	1	MZ30	MZ36
	150	165	270	160	450	90	530	220	160	60	325	106	M24	M30	M24	SSN230	60	R 1/4	R 1/4	—	22230RHR 23230RH	SR270×16.5 SR270×10	2 1	MZ33	MZ37
145	150	170	320	190	560	110	650	245	180	65	385	118	M30	M30	M24	SSN330	132	R 1/4	R 1/4	—	22330R	SR320×10	1	MZ33	MZ38
	160	175	290	170	470	90	550	235	160	60	345	114	M24	M30	M24	SSN232	69	R 1/4	R 1/4	—	22232R 23232R	SR290×17 SR290×10	2 1	MZ34	MZ39
150	160	180	340	200	580	110	680	255	190	70	405	124	M30	M36	M30	SSN332	145	R 1/4	R 1/4	—	22332R	SR340×10	1	MZ34	MZ40

[Notes] 1) Dimension  $x$  shows the shear between center of bearing and housing when one stabilizing ring is used. The value is 1/2 the width dimension of stabilizing ring.  
 When mounting two stabilizing rings,  $x$  becomes equal to 0, since they are mounted to each side of bearing.  
 2) If bearing of shaft diameter marked with \* (shoulder diameter) receives large axial load, the use of spacers is recommended.

[Remarks] 1) Large bore diameter types (concentric collar locking) are identified by B suffixed to housing numbers.  
 2) Housings shown below are equipped with eyebolts.  
 SSN224~SSN232, SSN318~SSN332

Plummer blocks  
split type, large size

SD 5, 6  
SD 33, 34

$d_1$  150 ~ 240 mm

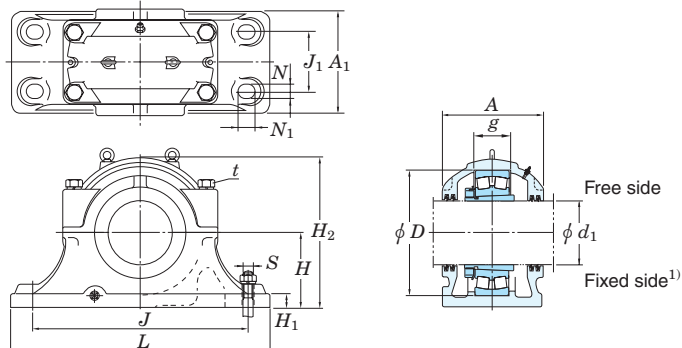

Shaft dia. (mm)	Dimensions (mm)												Bolt size	Housing No.	(Refer.) Housing mass (kg)	Grease nipple size	Drain plug size	Applicable bearing No.	Applicable adapter ass'y No.	Applicable oil seal No. MZ	
	$d_1$	D	H	J	$J_1$	L	A	$A_1$	$H_1$	$H_2$	N	$N_1$									g
150	260	160	450	110	540	230	200	50	315	36	46	77	M24	M30	SD3334	70	R 3/8	R 3/8	23034RHK	H3034	MZ34
	310	180	510	140	620	270	250	60	360	36	46	96	M24	M30	SD534	105	R 3/8	R 3/8	22234RK	H3134	MZ34
	360	210	610	170	740	300	290	65	420	36	46	130	M30	M30	SD634	165	R 3/8	R 3/8	22334RK	H2334	MZ34
160	280	170	470	120	560	250	220	50	335	36	46	84	M24	M30	SD3336	80	R 3/8	R 3/8	23036RHK	H3036	MZ36
	320	190	540	150	650	280	260	60	380	36	46	96	M24	M30	SD536	120	R 3/8	R 3/8	22236RK	H3136	MZ36
	380	225	640	180	780	320	310	70	450	43	59	136	M30	M36	SD636	200	R 3/8	R 3/8	22336RK	H2336	MZ36
170	290	170	470	120	560	250	220	50	340	36	46	85	M24	M30	SD3338	90	R 3/8	R 3/8	23038RK	H3038	MZ38
	340	200	570	160	700	290	280	65	400	36	46	102	M30	M30	SD538	145	R 3/8	R 3/8	22238RK	H3138	MZ38
	400	240	680	190	820	330	320	70	475	43	59	142	M30	M36	SD638	220	R 3/8	R 3/8	22338RK	H2338	MZ38
180	310	180	510	140	620	270	250	60	360	36	46	92	M24	M30	SD3340	100	R 3/8	R 3/8	23040RK	H3040	MZ40
	340	200	570	160	700	310	280	65	400	36	46	122	M30	M30	SD3440	135	R 3/8	R 3/8	23140RK	H3140	MZ40
	360	210	610	170	740	300	290	65	420	36	46	108	M30	M30	SD540	170	R 3/8	R 3/8	22240RK	H3140	MZ40
	420	250	710	200	860	350	340	85	500	43	59	148	M36	M36	SD640	250	R 3/8	R 1/2	22340RK	H2340	MZ40
200	340	200	570	160	700	290	280	65	400	36	46	100	M30	M30	SD3344	130	R 3/8	R 3/8	23044RK	H3044	MZ44
	370	225	640	180	780	320	310	70	445	43	59	130	M30	M36	SD3444	185	R 3/8	R 3/8	23144RK	H3144	MZ44
	400	240	680	190	820	330	320	70	475	43	59	118	M30	M36	SD544	220	R 3/8	R 3/8	22244RK	H3144	MZ44
	460	280	770	210	920	360	350	85	550	43	59	155	M36	M36	SD644	320	R 3/8	R 1/2	22344RK	H2344	MZ44
220	360	210	610	170	740	300	290	65	420	36	46	102	M30	M30	SD3348	160	R 3/8	R 3/8	23048RK	H3048	MZ48
	400	240	680	190	820	330	320	70	475	43	59	138	M30	M36	SD3448	210	R 3/8	R 3/8	23148RK	H3148	MZ48
	440	260	740	200	880	340	330	85	515	43	59	130	M36	M36	SD548	260	R 3/8	R 1/2	22248RK	H3148	MZ48
	500	300	830	230	990	390	380	100	590	50	67	165	M36	M42	SD648	415	R 3/8	R 1/2	22348RK	H2348	MZ48
240	400	240	680	190	820	340	320	70	475	43	59	114	M30	M36	SD3352	215	R 3/8	R 3/8	23052RK	H3052	MZ52
	440	260	740	200	880	360	350	85	515	43	59	154	M36	M36	SD3452	245	R 3/8	R 1/2	23152RK	H3152	MZ52
	480	280	790	210	940	370	360	85	560	43	59	140	M36	M36	SD552	325	R 3/8	R 1/2	22252RK	H3152	MZ52
	540	325	890	250	1060	410	400	100	640	50	67	175	M36	M42	SD652	490	R 3/8	R 3/4	22352RK	H2352	MZ52

[Note] 1) Since bearings are designed to be locked by housing, stabilizing rings are unnecessary.

[Remark] The structure of certain housings may differ from those shown in the figures.

Plummer blocks  
split type, large size

SD 5, 6  
SD 33, 34

$d_1$  260 ~ 360 mm

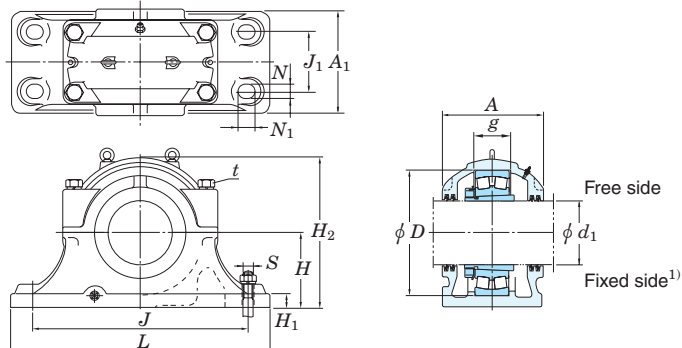

Shaft dia. (mm) $d_1$	Dimensions (mm)												Bolt size $S$	Housing No.	(Refer.) Housing mass (kg)	Grease nipple size	Drain plug size	Applicable bearing No.	Applicable adapter ass'y No.	Applicable oil seal No. MZ	
	$D$	$H$	$J$	$J_1$	$L$	$A$	$A_1$	$H_1$	$H_2$	$N$	$N_1$	$g$									$t$ Bolt size
260	420	250	710	200	860	350	340	85	500	43	59	116	M36	M36	SD3356	245	R 3/8	R 1/2	23056RK	H3056	MZ56
	460	280	770	210	920	360	350	85	550	43	59	156	M36	M36	SD3456	320	R 3/8	R 1/2	23156RK	H3156	MZ56
	500	300	830	230	990	390	380	100	590	50	67	140	M36	M42	SD556	395	R 3/8	R 1/2	22256RK	H3156	MZ56
	580	355	930	270	1 110	440	430	110	690	57	77	185	M42	M48	SD656	615	R 3/8	R 3/4	22356RK	H2356	MZ56
280	460	280	770	210	920	360	350	85	550	43	59	128	M36	M36	SD3360	305	R 3/8	R 1/2	23060RK	H3060	MZ60
	500	300	830	230	990	390	380	100	590	50	67	170	M36	M42	SD3460	400	R 3/8	R 1/2	23160RK	H3160	MZ60
	540	325	890	250	1 060	410	400	100	640	50	67	150	M36	M42	SD560	490	R 3/8	R 3/4	22260RK	H3160	MZ60
300	480	280	790	210	940	380	360	85	560	43	59	131	M36	M36	SD3364	325	R 3/8	R 1/2	23064RK	H3064	MZ64
	540	325	890	250	1 060	430	400	100	640	50	67	186	M36	M42	SD3464	480	R 3/8	R 3/4	23164RK	H3164	MZ64
	580	355	930	270	1 110	440	430	110	690	57	77	160	M42	M48	SD564	600	R 3/8	R 3/4	22264RK	H3164	MZ64
320	520	310	860	230	1 020	400	370	100	615	50	67	143	M36	M42	SD3368	420	R 3/8	R 3/4	23068RK	H3068	MZ68
	580	355	930	270	1 110	470	450	110	690	57	77	200	M42	M48	SD3468	645	R 3/8	R 3/4	23168RK	H3168	MZ68
340	540	325	890	250	1 060	410	390	100	640	50	67	144	M36	M42	SD3372	470	R 3/8	R 3/4	23072RK	H3072	MZ72
360	560	340	900	260	1 080	410	390	100	665	50	67	145	M36	M42	SD3376	485	R 3/8	R 3/4	23076RK	H3076	MZ76

[Note] 1) Since bearings are designed to be locked by housing, stabilizing rings are unnecessary.

[Remark] The structure of certain housings may differ from those shown in the figures.



Plummer blocks  
split type, large size

SD 31

$d_1$  150 ~ 300 mm

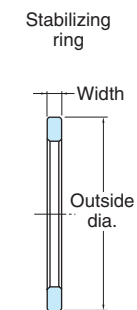
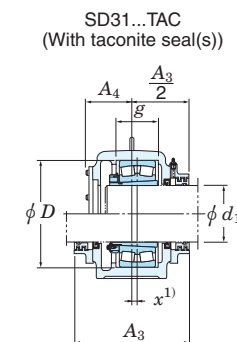
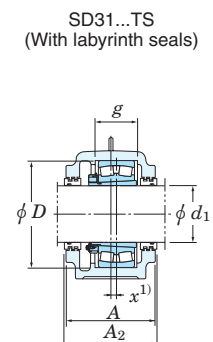
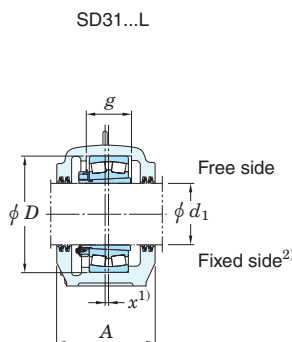
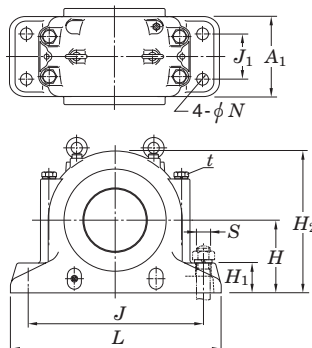

Shaft dia. (mm)	Dimensions (mm)																Housing No.	Bolt size S	(Refer.) Housing mass (kg)	Grease nipple size	Drain plug size	Applicable bearing No.	Applicable adapter ass'y No.	Applicable stabilizing ring <sup>2)</sup>	
	$d_1$	D	H	J	$J_1$	L	A	$A_1$	$A_2$	$A_3$	$A_4$	$H_1$	$H_2$	N	g	$t$ Bolt size								$x^{1)}$	Outside dia.
150	280	170	430	100	510	230	180	240	300	120	70	335	28	108	M20	14	SD3134L	M24	65	R 3/8	R 3/8	23134RHK	H3134	SR280×10	2
160	300	180	450	110	530	240	190	250	310	125	75	355	28	116	M20	15	SD3136L	M24	75	R 3/8	R 3/8	23136RK	H3136	SR300×10	2
170	320	190	480	120	560	260	210	270	330	135	80	375	28	124	M24	10	SD3138L	M24	95	R 3/8	R 3/8	23138RK	H3138	SR320×10	2
180	340	210	510	130	610	280	230	290	350	145	85	410	35	132	M24	10	SD3140L	M30	120	R 3/8	R 3/8	23140RK	H3140	SR340×10	2
200	370	220	540	140	640	290	240	300	360	152	90	435	35	140	M24	12	SD3144L	M30	140	R 3/8	R 3/8	23144RK	H3144	SR370×10	2
220	400	240	600	150	700	310	260	320	380	162	95	475	35	148	M30	12	SD3148L	M30	180	R 3/8	R 3/8	23148RK	H3148	SR400×10	2
240	440	260	650	160	770	320	280	330	396	170	100	515	42	164	M30	13	SD3152L	M36	220	R 3/8	R 1/2	23152RK	H3152	SR440×10	2
260	460	280	670	160	790	320	280	330	396	170	105	550	42	166	M30	16	SD3156L	M36	250	R 3/8	R 1/2	23156RK	H3156	SR460×10	2
280	500	300	710	190	830	350	310	360	420	193	110	590	42	180	M30	22	SD3160L	M36	300	R 3/8	R 1/2	23160RK	H3160	SR500×10	2
300	540	320	750	200	880	370	330	380	440	203	115	630	42	196	M30	23	SD3164L	M36	340	R 3/8	R 3/4	23164RK	H3164	SR540×10	2

[Notes] 1) Dimension x shows the shear between center of bearing and housing.  
2) Stabilizing rings are mounted to the fixed side of the SD 31...TS and SD 31 ...TAC series (both sides of bearings).  
SD31...L series are locked by housings.

[Remark] Use of labyrinth or taconite seals are indicated by TS or TAC suffixed to housing numbers.



Plummer blocks  
one-piece type

V 5, 6

$d_1$  30 ~ 65 mm

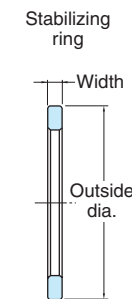
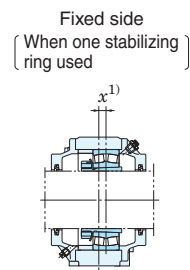
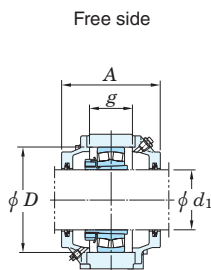
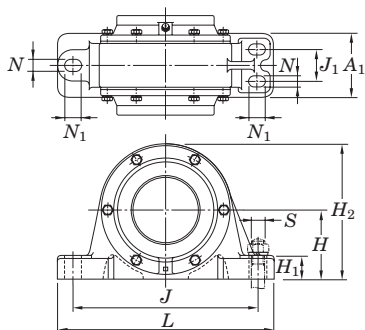

Shaft dia. (mm) $d_1$	Dimensions (mm)												Bolt size $S$		Housing No.	(Refer.) Housing mass (kg)	Grease nipple size	Drain plug size	Housing No.	Applicable bearing No.		Applicable adapter ass'y No.	Applicable stabilizing ring		Applicable oil seal No. MZ
	$D$	$H$	$J$	$J_1$	$L$	$A$	$A_1$	$H_1$	$H_2$	$N$	$N_1$	$g$	(Two)	(Four)						Self-aligning ball brg.	Spherical roller brg.		Outside dia.×Width	Qty.	
30	80	60	170	—	205	95	60	25	118	16	20	37	M14	—	V607	4.8	R 1/8	R 1/8	V080	1307K 2307K	—	H307X H2307X	SR80×8 SR80×6	2 1	MZ07
	80	60	170	—	205	95	60	25	118	16	20	37	M14	—	V508	4.4	R 1/8	R 1/8	V080	1208K 2208K	— 22208RHRK	H208X H308X	SR80×9.5 SR80×7	2 2	MZ08
35	90	67	170	—	205	100	60	25	128	16	20	39	M14	—	V608	5.1	R 1/8	R 1/8	V090	1308K 2308K	21308RHK 22308RHRK	H308X H2308X	SR90×8 SR90×6	2 1	MZ08
	85	63	170	—	205	98	60	25	125	16	20	39	M14	—	V509	4.6	R 1/8	R 1/8	V085	1209K 2209K	— 22209RHRK	H209X H309X	SR85×10 SR85×8	2 2	MZ09
40	100	71	210	—	255	106	70	28	140	16	23	42	M14	—	V609	6.6	R 1/8	R 1/8	V100	1309K 2309K	21309RHK 22309RHRK	H309X H2309X	SR100×8.5 SR100×6	2 1	MZ09
	90	67	170	—	205	100	60	25	128	16	20	39	M14	—	V510	4.7	R 1/8	R 1/8	V090	1210K 2210K	— 22210RHRK	H210X H310X	SR90×9.5 SR90×8	2 2	MZ10
45	110	80	210	—	255	112	70	30	155	21	25	46	M18	—	V610	8.3	R 1/8	R 1/8	V110	1310K 2310K	21310RHK 22310RHRK	H310X H2310X	SR110×9.5 SR110×6	2 1	MZ10
	100	71	210	—	255	106	70	28	140	16	23	42	M14	—	V511	6.2	R 1/8	R 1/8	V100	1211K 2211K	— 22211RHRK	H211X H311X	SR100×10.5 SR100×8.5	2 2	MZ11
50	120	85	230	—	275	118	80	30	165	21	25	49	M18	—	V611	10	R 1/8	R 1/8	V120	1311K 2311K	21311RHK 22311RHRK	H311X H2311X	SR120×10 SR120×6	2 1	MZ11
	110	80	210	—	255	112	70	30	155	21	25	46	M18	—	V512	7.6	R 1/8	R 1/8	V110	1212K 2212K	— 22212RHRK	H212X H312X	SR110×12 SR110×9	2 2	MZ12
55	130	90	230	—	280	118	80	30	175	21	25	50	M18	—	V612	11	R 1/8	R 1/8	V130	1312K 2312K	21312RHK 22312RHRK	H312X H2312X	SR130×9.5 SR130×4	2 1	MZ12
	120	85	230	—	275	118	80	30	165	21	25	49	M18	—	V513	9.9	R 1/8	R 1/8	V120	1213K 2213K	— 22213RHRK	H213X H313X	SR120×13 SR120×9	2 2	MZ13
60	125	90	230	—	280	118	80	30	175	21	25	50	M18	—	V514	10	R 1/8	R 1/8	V125	—	22214RHRK	H314X	SR125×9.5	2	MZ13
	140	100	260	—	315	136	90	32	195	25	30	56	M22	—	V613	17	R 1/8	R 1/8	V140	1313K 2313K	21313RHK 22313RHRK	H313X H2313X	SR140×11.5 SR140×8	2 1	MZ13
65	150	100	260	—	315	140	90	32	195	25	30	56	M22	—	V614	16	R 1/8	R 1/8	V150	—	21314RHK 22314RHRK	H314X H2314X	SR150×10.5 SR150×5	2 1	MZ13
	130	90	230	—	280	118	80	30	175	21	25	50	M18	—	V515	10	R 1/8	R 1/8	V130	1215K 2215K	— 22215RHRK	H215X H315X	SR130×12.5 SR130×9.5	2 2	MZ15
	160	112	290	—	345	150	100	35	224	25	30	62	M22	—	V615	23	R 1/8	R 1/8	V160	1315K 2315K	21315RHK 22315RHRK	H315X H2315X	SR160×12.5 SR160×7	2 1	MZ15

[Note] 1) Dimension x shows the shear between center of bearing and housing when one stabilizing ring is used. The value is 1/2 the width dimension of stabilizing ring. When mounting two stabilizing rings, x becomes equal to 0, since they are mounted to each side of bearing.

[Remark] Housings shown below are equipped with eyebolts. V180~V340 (V520~V538 and V617~V632)

Plummer blocks  
one-piece type

V 5, 6

$d_1$  70 ~ (125) mm

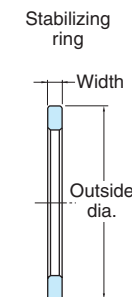
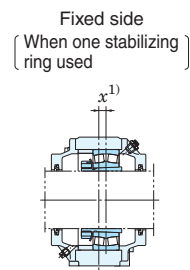
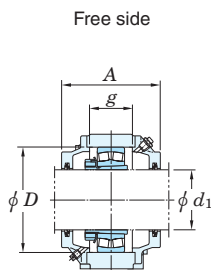
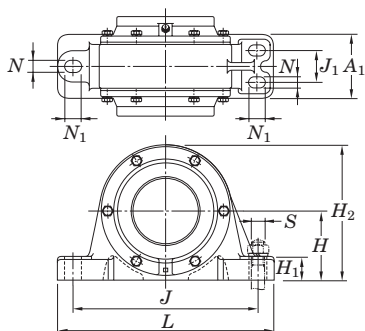

Shaft dia. (mm) $d_1$	Dimensions (mm)												Bolt size $S$		Housing No.	(Refer.) Housing mass (kg)	Grease nipple size	Drain plug size	Housing No.	Applicable bearing No.		Applicable adapter ass'y No.	Applicable stabilizing ring		Applicable oil seal No. MZ
	$D$	$H$	$J$	$J_1$	$L$	$A$	$A_1$	$H_1$	$H_2$	$N$	$N_1$	$g$	(Two)	(Four)						Self-aligning ball brg.	Spherical roller brg.		Outside dia. $\times$ Width	Qty.	
70	140	100	260	—	315	136	90	32	195	25	30	56	M22	—	V516	16	R 1/8	R 1/8	V140	1216K 2216K	— 22216RHRK	H216X H316X	SR140x15 SR140x11.5	2 2	MZ16
	170	112	290	—	345	165	100	35	224	25	30	62	M22	—	V616	22	R 1/8	R 1/8	V170	1316K 2316K	21316RHK 22316RHRK	H316X H2316X	SR170x11.5 SR170x4	2 1	MZ16
75	150	100	260	—	315	140	90	32	195	25	30	56	M22	—	V517	15	R 1/8	R 1/8	V150	1217K 2217K	— 22217RHRK	H217X H317X	SR150x14 SR150x10	2 2	MZ17
	180	125	320	56	380	170	110	40	243	23	32	70	—	M20	V617	28	R 1/4	R 1/4	V180	1317K 2317K	21317RHK 22317RHRK	H317X H2317X	SR180x14.5 SR180x10	2 1	MZ17
80	160	112	290	—	345	150	100	35	224	25	30	62	M22	—	V518	22	R 1/8	R 1/8	V160	1218K 2218K	— 22218RHRK	H218X H318X	SR160x16 SR160x11	2 2	MZ18
	190	125	320	56	380	170	110	40	243	23	32	70	—	M20	V618	27	R 1/4	R 1/4	V190	1318K 2318K	21318RHK 22318RHRK	H318X H2318X	SR190x13.5 SR190x6	2 1	MZ18
85	170	112	290	—	345	165	100	35	224	25	30	62	M22	—	V519	21	R 1/8	R 1/8	V170	1219K 2219K	— 22219RHRK	H219X H319X	SR170x11 SR170x9.5	2 2	MZ19
	200	132	350	60	410	190	120	45	265	23	32	82	—	M20	V619	37	R 1/4	R 1/4	V200	1319K 2319K	21319RHK 22319RHRK	H319X H2319X	SR200x18.5 SR200x15	2 1	MZ19
90	180	125	320	56	380	170	110	40	243	23	32	70	—	M20	V520	27	R 1/4	R 1/4	V180	1220K 2220K	— 22220RHRK	H220X H320X	SR180x18 SR180x12	2 2	MZ20
	215	140	350	60	410	190	120	45	280	23	32	82	—	M20	V620	40	R 1/4	R 1/4	V215	1320K 2320K	21320RHK 22320RHRK	H320X H2320X	SR215x17.5 SR215x9	2 1	MZ20
100	200	132	350	60	410	190	120	45	265	23	32	82	—	M20	V522	36	R 1/4	R 1/4	V200	1222K 2222K	— 22222RHRK	H222X H322X	SR200x22 SR200x14.5	2 2	MZ22
	240	160	390	80	470	218	150	50	315	23	32	96	—	M20	V622	56	R 1/4	R 1/4	V240	1322K 2322K	21322RHK 22322RHRK	H322X H2322X	SR240x23 SR240x16	2 1	MZ22
110	215	140	350	60	410	190	120	45	280	23	32	82	—	M20	V524	39	R 1/4	R 1/4	V215	—	22224RHRK 23224RHK	H3124 H2324	SR215x12 SR215x6	2 1	MZ24
	260	170	450	92	540	236	160	60	335	29	42	103	—	M24	V624	71	R 1/4	R 1/4	V260	—	22324RHRK	H2324	SR260x17	1	MZ24
115	230	150	380	65	450	200	130	50	300	23	32	86	—	M20	V526	48	R 1/4	R 1/4	V230	—	22226RHRK 23226RHK	H3126 H2326	SR230x11 SR230x6	2 1	MZ26
	280	180	470	92	560	243	160	60	355	29	42	103	—	M24	V626	82	R 1/4	R 1/4	V280	—	22326RHRK	H2326	SR280x15	1	MZ26
125	250	160	420	80	500	218	150	50	315	23	32	94	—	M20	V528	54	R 1/4	R 1/4	V250	—	22228RHRK 23228RHK	H3128 H2328	SR250x13 SR250x6	2 1	MZ28

[Note] 1) Dimension  $x$  shows the shear between center of bearing and housing when one stabilizing ring is used. The value is 1/2 the width dimension of stabilizing ring.  
When mounting two stabilizing rings,  $x$  becomes equal to 0, since they are mounted to each side of bearing.

[Remark] Housings shown below are equipped with eyebolts.  
V180~V340 (V520~V538 and V617~V632)

Plummer blocks  
one-piece type

V 5, 6

$d_1$  (125) ~ 170 mm

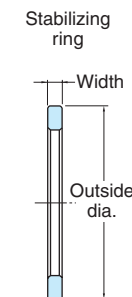
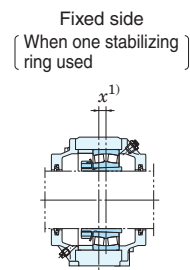
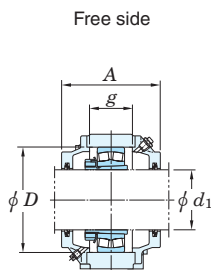
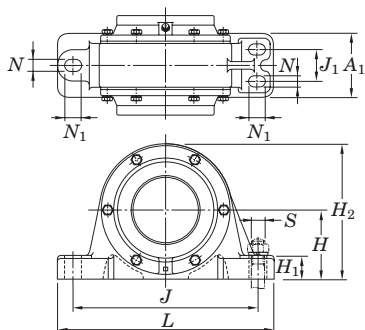

Shaft dia. (mm) $d_1$	Dimensions (mm)												Bolt size $S$		Housing No.	(Refer.) Housing mass (kg)	Grease nipple size	Drain plug size	Housing No.	Applicable bearing No.		Applicable adapter ass'y No.	Applicable stabilizing ring		Applicable oil seal No. MZ
	$D$	$H$	$J$	$J_1$	$L$	$A$	$A_1$	$H_1$	$H_2$	$N$	$N_1$	$g$	(Two)	(Four)						Self-aligning ball brg.	Spherical roller brg.		Outside dia. $\times$ Width	Qty.	
125	300	190	520	92	610	250	170	65	375	29	50	113	—	M24	V628	101	R 1/4	R 1/4	V300	—	22328RK	H2328	SR300 $\times$ 11	1	MZ28
135	270	170	450	92	540	236	160	60	335	29	42	103	—	M24	V530	64	R 1/4	R 1/4	V270	—	22230RHRK 23230RHK	H3130 H2330	SR270 $\times$ 15 SR270 $\times$ 7	2 1	MZ30
	320	200	560	92	660	258	180	65	405	29	50	122	—	M24	V630	129	R 1/4	R 1/4	V320	—	22330RK	H2330	SR320 $\times$ 14	1	MZ30
140	290	190	470	92	560	250	170	60	375	29	50	113	—	M24	V532	92	R 1/4	R 1/4	V290	—	22232RK 23232RK	H3132 H2332	SR290 $\times$ 16.5 SR290 $\times$ 9	2 1	MZ32
	340	212	580	104	680	300	190	65	425	33	54	130	—	M27	V632	149	R 1/4	R 1/4	V340	—	22332RK	H2332	SR340 $\times$ 16	1	MZ32
150	310	200	560	92	660	258	180	65	405	29	50	122	—	M24	V534	110	R 1/4	R 1/4	V310	—	22234RK 23234RK	H3134 H2334	SR310 $\times$ 18 SR310 $\times$ 12	2 1	MZ34
160	320	200	560	92	660	258	180	65	405	29	50	122	—	M24	V536	110	R 1/4	R 1/4	V320	—	22236RK 23236RK	H3136 H2336	SR320 $\times$ 18 SR320 $\times$ 10	2 1	MZ36
170	340	212	580	104	680	300	190	65	425	33	54	130	—	M27	V538	130	R 1/4	R 1/4	V340	—	22238RK 23238RK	H3138 H2338	SR340 $\times$ 19 SR340 $\times$ 10	2 1	MZ38

[Note] 1) Dimension  $x$  shows the shear between center of bearing and housing when one stabilizing ring is used. The value is 1/2 the width dimension of stabilizing ring. When mounting two stabilizing rings,  $x$  becomes equal to 0, since they are mounted to each side of bearing.

[Remark] Housings shown below are equipped with eyebolts. V180~V340 (V520~V538 and V617~V632)